

Ethernet Switching Configuration

Оглавление

1.	Configuring Interfaces	1
1.1	Overview	1
1.2	Applications	1
1.2.1	L2 Data Switching Through the Physical Ethernet Interface.....	1
1.2.2	L3 Routing Through the Physical Ethernet Interface	2
1.3	Features.....	3
1.3.1	Interface Configuration Commands	6
1.3.2	Interface Description and Administrative Status	8
1.3.3	MTU.....	8
1.3.4	Bandwidth	9
1.3.5	Load Interval	9
1.3.6	Carrier Delay.....	9
1.3.7	Link Trap Policy	10
1.3.8	Interface Index Persistence	10
1.3.9	Routed Port	10
1.3.10	L3 AP Port.....	10
1.3.11	Interface Speed, Duplex Mode, Flow Control Mode, and Auto Negotiation Mode	11
1.3.12	Automatic Module Detection.....	13
1.3.13	Protected Port.....	13
1.3.14	Port Errdisable Recovery	14
1.3.15	Split and Combination of the 40G Port	14
1.4	Configuration.....	14
1.4.1	Performing Basic Configurations.....	15
1.4.2	Configuring Interface Attributes	25
1.5	Monitoring.....	38
2.	Configuring MAC Address.....	40
2.1	Overview	40
2.2	Applications	40
2.2.1	MAC Address Learning	40
2.2.2	MAC Address Change Notification	42

2.3	Features.....	43
2.3.1	Dynamic Address Limit for VLAN.....	43
2.3.2	Dynamic Address Limit for Interface.....	44
2.4	Configuration.....	44
2.4.1	Configuring Dynamic MAC Address.....	45
2.4.2	Configuring a Static MAC Address.....	48
2.4.3	Configuring a MAC Address for Packet Filtering.....	51
2.4.4	Configuring MAC Address Change Notification.....	52
2.4.5	Configuring a Management VLAN for an AP Port.....	57
2.5	Monitoring.....	58
3.	Configuring Aggregate Port.....	59
3.1	Overview.....	59
3.2	Applications.....	59
3.2.1	AP Link Aggregation and Load Balancing.....	60
3.3	Features.....	60
3.3.1	Link Aggregation.....	64
3.3.2	Load Balancing.....	64
3.4	Configuration.....	66
3.4.1	Configuring Static AP Ports.....	68
3.4.2	Configuring LACP AP Ports.....	72
3.4.3	Enabling LinkTrap.....	76
3.4.4	Configuring a Load Balancing Mode.....	79
3.4.5	Configuring an AP Capacity Mode.....	86
3.4.6	Configuring a Preferred AP Member Port.....	89
3.4.7	Configuring the Minimum Number of LACP AP Member Ports.....	91
3.5	Monitoring.....	94
4.	Configuring ECMP Cluster.....	96
4.1	Overview.....	96
4.2	Applications.....	96
4.2.1	Interconnecting LVS Load Balancing Cluster to TOR Device Via ECMP.....	96
4.3	Features.....	98
4.4	Configuration.....	98
4.4.1	Configuring ECMP-CLUSTER.....	99
4.5	Monitoring.....	100

5.	Configuring VLAN	101
5.1	Overview	101
5.2	Applications	102
5.2.1	Isolating VLANs at Layer 2 and Interconnecting VLANs at Layer 3.....	102
5.3	Features.....	103
5.3.1	VLAN.....	103
5.4	Configuration.....	104
5.4.1	Configuring Basic VLAN	105
5.4.2	Configuring a Trunk Port	108
5.4.3	Configuring an Uplink Port.....	114
5.4.4	Configuring a Hybrid Port.....	117
5.5	Monitoring.....	119
6.	Configuring MAC VLAN.....	121
6.1	Overview	121
6.2	Applications	121
6.2.1	Configuring MAC VLAN.....	121
6.3	Overview	122
6.3.1	Configuring MAC VLAN.....	122
6.4	Configuration.....	123
6.4.1	Enabling MAC VLAN on a Port.....	123
6.4.2	Adding a Static MAC VLAN Entry Globally.....	124
6.5	Monitoring.....	129
7.	Configuring Super VLAN	130
1.1	Overview	130
7.1	Application.....	130
7.1.1	Sharing One IP Gateway Among Multiple VLANs.....	130
7.2	Features.....	131
7.2.1	Super VLAN	132
7.3	Configuration.....	132
7.3.1	Configuring Basic Functions of the Super VLAN	133
7.4	Monitoring.....	139
8.	Configuring Protocol VLAN	140
8.1	Overview	140
8.2	Applications	140



8.2.1	Configuration and Application of Protocol VLAN	140
8.2.2	Configuration and Application of Subnet VLAN	141
8.3	Features.....	142
8.3.1	Automatic VLAN Distribution Based on Packet Type	143
8.4	Configuration.....	144
8.4.1	Configuring the Protocol VLAN Function	144
8.4.2	Configuring the Subnet VLAN Function.....	148
8.5	Monitoring.....	152
9.	Configuring Private VLAN	153
9.1	Overview	153
9.2	Applications	153
9.2.1	Cross-Device Layer-2 Application of PVLAN	153
9.2.2	Layer-3 Application of PVLAN on a Single Device.....	155
9.3	Features.....	156
9.3.1	PVLAN Layer-2 Isolation and IP Address Saving	158
9.4	Configuration.....	160
9.4.1	Configuring Basic Functions of PVLAN	161
9.5	Monitoring.....	175
10.	Configuring MSTP	176
10.1	Overview	176
10.2	Applications	177
10.2.1	MSTP+VRRP Dual-Core Topology	177
10.2.2	BPDU Tunnel.....	178
10.3	Features.....	179
10.3.1	STP.....	183
10.3.2	RSTP.....	184
10.3.3	MSTP	187
10.3.4	MSTP Optional Features.....	193
10.4	Configuration.....	200
10.4.1	Enabling STP	202
10.4.2	Configuring STP Compatibility.....	206
10.4.3	Configuring an MSTP Region	211
10.4.4	Enabling Fast RSTP Convergence	220
10.4.5	Configuring Priorities.....	222

10.4.6	Configuring the Port Path Cost.....	226
10.4.7	Configuring the Maximum Hop Count of a BPDU Packet.....	230
10.4.8	Enabling PortFast-related Features.....	232
10.4.9	Enabling TC-related Features.....	236
10.4.10	Enabling BPDU Source MAC Address Check.....	239
10.4.11	Configuring Auto Edge.....	241
10.4.12	Enabling Guard-related Features.....	243
10.4.13	Enabling BPDU Transparent Transmission.....	247
10.4.14	Enabling BPDU Tunnel.....	249
10.5	Monitoring.....	253
11.	Configuring GVRP.....	255
11.1	Overview.....	255
11.2	Applications.....	255
11.2.1	GVRP Configuration in a LAN.....	255
11.2.2	GVRP PDUs Tunnel Application.....	256
11.3	Features.....	257
11.3.1	Intra-Topology VLAN Information Synchronization.....	260
11.4	If dynamic VLAN registration is enabled, dynamic VLANs will be created on the local device when the port receives a GVRP packet carrying VLAN information from the peer end. If dynamic VLAN registration is disabled, no dynamic VLAN will be created on the local device when the port receives a GVRP packet from the peer end. Configuration.....	261
11.4.1	Configuring Basic GVRP Features and VLAN Information Synchronization.....	262
11.4.2	Enabling GVRP PDUs Transparent Transmission.....	268
11.4.3	Configuring the GVRP PDUs Tunnel Feature.....	270
11.5	Monitoring.....	274
12.	Configuring LLDP.....	275
12.1	Overview.....	275
12.2	Applications.....	275
12.2.1	Displaying Topology.....	275
12.2.2	Conducting Error Detection.....	276
12.3	Features.....	277
12.3.1	LLDP Work Mode.....	280
12.3.2	LLDP Transmission Mechanism.....	281
12.3.3	LLDP Reception Mechanism.....	283

12.4	Configuration.....	283
12.4.1	Configuring the LLDP Function	286
12.4.2	Configuring the LLDP Work Mode.....	288
12.4.3	Configuring the TLVs to Be Advertised.....	289
12.4.4	Configures the Management Address to Be Advertised	293
12.4.5	Configuring the LLDP Fast Transmission Count.....	296
12.4.6	Configuring the TTL Multiplier and Transmission Interval	297
12.4.7	Configuring the Transmission Delay.....	299
12.4.8	Configuring the Initialization Delay	301
12.4.9	Configuring the LLDP Trap Function.....	302
12.4.10	Configuring the LLDP Error Detection Function	305
12.4.11	Configuring the LLDP Encapsulation Format.....	306
12.4.12	Configuring the LLDP Network Policy.....	308
12.4.13	Configuring the Civic Address	310
12.4.14	Configuring the Emergency Telephone Number.....	312
12.5	Monitoring.....	313
13.	Configuring QinQ.....	315
13.1	Overview	315
13.2	Applications	316
13.2.1	Implementing Layer-2 VPN Through Port-Based Basic QinQ.....	316
13.2.2	Implementing Layer-2 VPN and Service Flow Management Through C-TAG-Based Selective QinQ	317
13.2.3	Implementing Layer-2 VPN and Service Flow Management Through ACL-Based Selective QinQ.....	319
13.2.4	Implementing VLAN Aggregation for Different Services Through VLAN Mapping.....	320
13.2.5	Implementing QinQ-Based Layer-2 Transparent Transmission.....	321
13.3	Features.....	322
13.3.1	Basic QinQ	324
13.3.2	Selective QinQ.....	324
13.3.3	VLAN Mapping	325
13.3.4	TPID Configuration	326
13.3.5	MAC Address Replication	326
13.3.6	Layer-2 Transparent Transmission	327
13.3.7	Priority Replication.....	328

13.3.8	Priority Mapping	328
13.4	Configuration.....	329
13.4.1	Configuring QinQ.....	331
13.4.2	Configuring C-TAG-Based Selective QinQ.....	336
13.4.3	Configuring ACL-Based Selective QinQ.....	340
13.4.4	Configuring VLAN Mapping	344
13.4.5	Configuring TPIDs	349
13.4.6	Configuring MAC Address Replication	351
13.4.7	Configuring an Inner/Outer VLAN Tag Modification Policy.....	353
13.4.8	Configuring Priority Mapping and Priority Replication	356
13.4.9	Configuring Layer-2 Transparent Transmission.....	359
13.5	Monitoring.....	364
14.	Configuring MGMT	365
14.1	Overview	365
14.2	Applications	365
14.2.1	Network Management Tool.....	366
14.2.2	File Management	366
14.2.3	Network Login Management.....	367
14.2.4	MIB Management	368
14.2.5	Log Management	369
14.3	Features.....	370
14.3.1	Interface Attribute Management	370
14.3.2	Network Management Tool.....	372
14.3.3	File Management	373
14.3.4	Network Login Management	373
14.3.5	MIB Management	374
14.3.6	Log Management	374
14.4	Configuration.....	375
14.4.1	Interface Attribute Management.....	377
14.4.2	Network Management Tool	381
14.4.3	File Management	384
14.4.4	Network Login Management	386
14.4.5	MIB Management	388
14.4.6	Log Management	390

14.5	Monitoring.....	392
15.	Configuring HASH Simulator.....	393
15.1	Overview	393
15.2	Applications.....	393
15.2.1	AP HASH Simulator.....	394
15.2.2	ECMP HASH Simulator.....	395
15.3	Features.....	396
15.3.1	AP HASH Simulator.....	397
15.3.2	ECMP HASH Simulator.....	399
15.4	Configuration.....	400
15.4.1	Displaying AP Load-Balanced Forwarding Port	401
15.4.2	Displaying ECMP Load-Balanced Forwarding Port	404



1. CONFIGURING INTERFACES

1.1 Overview

Interfaces are important in implementing data switching on network devices. Qtech devices support two types of interfaces: physical ports and logical interfaces. A physical port is a hardware port on a device, such as the 100M Ethernet interface and gigabit Ethernet interface. A logical interface is not a hardware port on the device. A logical interface, such as the loopback interface and tunnel interface, can be associated with a physical port or independent of any physical port. For network protocols, physical ports and logical interfaces serve the same function.

1.2 Applications

Application	Description
L2 Data Switching Through the Physical Ethernet Interface	Implement Layer-2 (L2) data communication of network devices through the physical L2 Ethernet interface.
L3 Routing Through the Physical Ethernet Interface	Implement Layer-3 (L3) data communication of network devices through the physical L3 Ethernet interface.

1. 2. 1 L2 Data Switching Through the Physical Ethernet Interface

Scenario

Figure 1-1

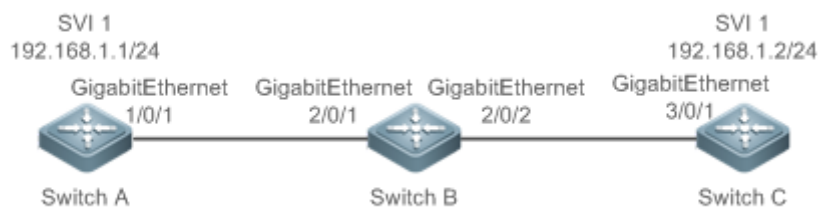

As shown in Figure 1-1, Switch A, Switch B, and Switch C form a simple L2 data switching network.

Deployment

- Connect Switch A to Switch B through physical ports GigabitEthernet 1/0/1 and GigabitEthernet 2/0/1.
- Connect Switch B to Switch C through physical ports GigabitEthernet 2/0/2 and GigabitEthernet 3/0/1.

- Configure GigabitEthernet 1/0/1, GigabitEthernet 2/0/1, GigabitEthernet 2/0/2, and GigabitEthernet3/0/1 as Trunk ports.
- Create a switch virtual interface (SVI), SVI 1, on Switch A and Switch C respectively, and configure IP addresses from a network segment for the two SVIs. The IP address of SVI 1 on Switch A is 192.168.1.1/24, and the IP address of SVI 1 on Switch C is 192.168.1.2/24.
- Run the **ping 192.168.1.2** command on Switch A and the **ping 192.168.1.1** command on Switch C to implement data switching through Switch B.

1.2.2 L3 Routing Through the Physical Ethernet Interface

Scenario

Figure 1-2

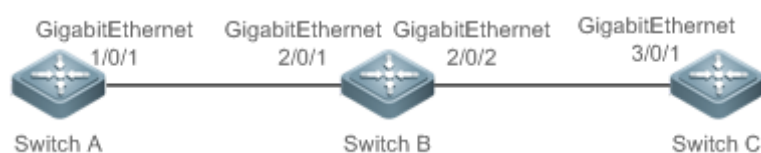

As shown in Figure 1-2, Switch A, Switch B, and Switch C form a simple L3 data communication network.

Deployment

- Connect Switch A to Switch B through physical ports GigabitEthernet 1/0/1 and GigabitEthernet 2/0/1.
- Connect Switch B to Switch C through physical ports GigabitEthernet 2/0/2 and GigabitEthernet 3/0/1.
- Configure GigabitEthernet 1/0/1, GigabitEthernet 2/0/1, GigabitEthernet 2/0/2, and GigabitEthernet3/0/1 as L3 routed ports.
- Configure IP addresses from a network segment for GigabitEthernet 1/0/1 and GigabitEthernet 2/0/1. The IP address of GigabitEthernet 1/0/1 is 192.168.1.1/24, and the IP address of GigabitEthernet 2/0/1 is 192.168.1.2/24.
- Configure IP addresses from a network segment for GigabitEthernet 2/0/2 and GigabitEthernet 3/0/1. The IP address of GigabitEthernet 2/0/2 is 192.168.2.1/24, and the IP address of GigabitEthernet 3/0/1 is 192.168.2.2/24.
- Configure a static route entry on Switch C so that Switch C can directly access the network segment 192.168.1.0/24.
- Run the **ping 192.168.2.2** command on Switch A and the **ping 192.168.1.1** command on Switch C to implement L3 routing through Switch B.

1.3 Features

Basic Concepts

❖ Interface Classification

Interfaces on Qtech devices fall into three categories:

- L2 interface
- L3 interface (supported by L3 devices)
- Fiber channel (FC) interface (supported by some data center products)

1. Common L2 interfaces are classified into the following types:

- Switch port
- L2 aggregate port (AP)

2. Common L3 interfaces are classified into the following types:

- Routed port
- L3 AP port
- SVI
- Loopback interface
- Tunnel interface

3. FC interfaces are classified into the following types:

- FC interface
- FC AP port

❖ Switch Port

A switch port is an individual physical port on the device, and implements only the L2 switching function. The switch port is used to manage physical ports and L2 protocols related to physical ports.

❖ L2 AP Port

An AP port is formed by aggregating multiple physical ports. Multiple physical links can be bound together to form a simple logical link. This logical link is called an AP port.

For L2 switching, an AP port is equivalent to a switch port that combines bandwidths of multiple ports, thus expanding the link bandwidth. Frames sent over the L2 AP port are balanced among

the L2 AP member ports. If one member link fails, the L2 AP port automatically transfers the traffic on the faulty link to other member links, improving reliability of connections.

❖ SVI

The SVI can be used as the management interface of the local device, through which the administrator can manage the device. You can also create an SVI as a gateway interface, which is mapped to the virtual interface of each VLAN to implement routing across VLANs among L3 devices. You can run the **interface vlan** command to create an SVI and assign an IP address to this interface to set up a route between VLANs.

As shown in Figure 1-3, hosts in VLAN 20 can directly communicate with each other without participation of L3 devices. If Host A in VLAN 20 wants to communicate with Host B in VLAN 30, SVI 1 of VLAN 20 and SVI 2 of VLAN 30 must be used.

Figure 1-3

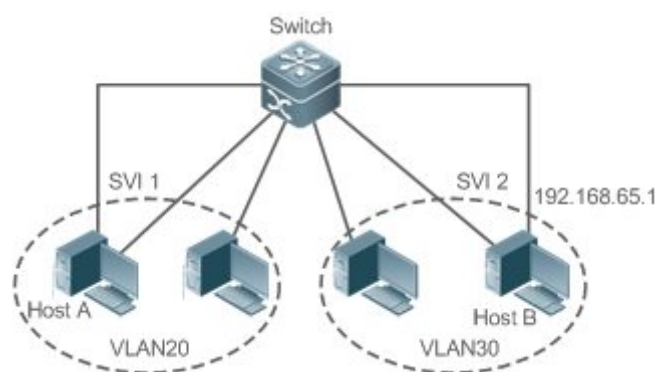

❖ Routed Port

A physical port on a L3 device can be configured as a routed port, which functions as the gateway interface for L3 switching. A routed port is not related with a specific VLAN. Instead, it is just an access port. The routed port cannot be used for L2 switching. You can run the **no switchport** command to change a switch port to a routed port and assign an IP address to this port to set up a route. Note that you must delete all L2 features of a switch port before running the **no switchport** command.

- If a port is a L2 AP member port or a DOT1X port that is not authenticated, you cannot run the **switchport** or **no switchport** command to configure the switch port or routed port.

❖ L3 AP Port

Like the L2 AP port, a L3 AP port is a logical port that aggregates multiple physical member ports. The aggregated ports must be the L3 ports of the same type. The AP port functions as a gateway interface for L3 switching. Multiple physical links are combined into one logical link, expanding the bandwidth of a link. Frames sent over the L3 AP port are balanced among the L3 AP member ports. If one member link fails, the L3 AP port automatically transfers the traffic on the faulty link to other member links, improving reliability of connections.

A L3 AP port cannot be used for L2 switching. You can run the **no switchport** command to change a L2 AP port that does not contain any member port into a L3 AP port, add multiple routed ports to this L3 AP port, and then assign an IP address to this L3 AP port to set up a route.

❖ Loopback Interface

The loopback interface is a local L3 logical interface simulated by the software that is always UP. Packets sent to the loopback interface are processed on the device locally, including the route information. The IP address of the loopback interface can be used as the device ID of the Open Shortest Path First (OSPF) routing protocol, or as the source address used by Border Gateway Protocol (BGP) to set up a TCP connection. The procedure for configuring a loopback interface is similar to that for configuring an Ethernet interface, and you can treat the loopback interface as a virtual Ethernet interface.

❖ Tunnel Interface

The Tunnel interface implements the tunnel function. Over the Tunnel interface, transmission protocols (e.g., IP) can be used to transmit packets of any protocol. Like other logical interfaces, the tunnel interface is also a virtual interface of the system. Instead of specifying any transmission protocol or load protocol, the tunnel interface provides a standard point-to-point (P2P) transmission mode. Therefore, a tunnel interface must be configured for every individual link.

❖ FC Interface

The FC interface is a physical port used to support communication between the FC storage area networks (SANs). You can configure different working modes (E, F, or NP) for the FC interface to set up connections with the existing or a newly-created FC SAN, thus implementing networking.

❖ FC AP Port

The FC AP port is similar to a L2 or L3 AP port. The FC AP port is a virtual logical port that binds multiple FC physical ports that work in E mode. Theoretically, the bandwidth of an FC AP port is equal to the sum of the bandwidths of all member ports. Therefore, the FC aggregation function can meet the requirement for a higher bandwidth.

Overview

Feature	Description
Interface Configuration Commands	You can configure interface-related attributes in interface configuration mode. If you enter interface configuration mode of a non-existing logical interface, the interface will be created.
Interface Description and Administrative Status	You can configure a name for an interface to identify the interface and help you remember the functions of the interface. You can also configure the administrative status of the interface.
MTU	You can configure the maximum transmission unit (MTU) of a port to limit the length of a frame that can be received or sent over this port.
Bandwidth	You can configure the bandwidth of an interface.

Feature	Description
Load Interval	You can specify the interval for load calculation of an interface.
Carrier Delay	You can configure the carrier delay of an interface to adjust the delay after which the status of an interface changes from Down to Up or from Up to Down.
Link Trap Policy	You can enable or disable the link trap function on an interface.
Interface Index Persistence	You can enable the interface index persistence function so that the interface index remains unchanged after the device is restarted.
Routed Port	You can configure a physical port on a L3 device as a routed port, which functions as the gateway interface for L3 switching.
L3 AP Port	You can configure an AP port on a L3 device as a L3 AP port, which functions as the gateway interface for L3 switching.
Interface Speed, Duplex Mode, Flow Control Mode, and Auto Negotiation Mode	You can configure the speed, duplex mode, flow control mode, and auto negotiation mode of an interface.
Automatic Module Detection	If the interface speed is set to auto, the interface speed can be automatically adjusted based on the type of the inserted module.
Protected Port	You can configure some ports as protected ports to disable communication between these ports. You can also disable routing between protected ports.
Port Errdisable Recovery	After a port is shut down due to a violation, you can run the errdisable recovery command in global configuration mode to recover all the ports in errdisable state and enable these ports.

1.3.1 Interface Configuration Commands

Run the **interface** command in global configuration mode to enter interface configuration mode. You can configure interface-related attributes in interface configuration mode.

Working Principle

Run the **interface** command in global configuration mode to enter interface configuration mode. If you enter interface configuration mode of a non-existing logical interface, the interface will be created. You can also run the **interface range** or **interface range macro** command in global configuration mode to configure the range (IDs) of interfaces. Interfaces defined in the same range must be of the same type and have the same features.

You can run the **no interface** command in global configuration mode to delete a specified logical interface.

❖ Interface Numbering Rules

In stand-alone mode, the ID of a physical port consists of two parts: slot ID and port ID on the slot. For example, if the slot ID of the port is 2, and port ID on the slot is 3, the interface ID is 2/3. In VSU or stack mode, the ID of a physical port consists of three parts: device ID, slot ID, and port ID on the slot. For example, if the device ID is 1, slot ID of the port is 2, and port ID on the slot is 3, the interface ID is 1/2/3.

The device ID ranges from 1 to the maximum number of supported member devices.

The slot number rules are as follows: The static slot ID is 0, whereas the ID of a dynamic slot (pluggable module or line card) ranges from 1 to the number of slots. Assume that you are facing the device panel. Dynamic slot are numbered from 1 sequentially from front to rear, from left to right, and from top to bottom.

The ID of a port on the slot ranges from 1 to the number of ports on the slot, and is numbered sequentially from left to right.

The ID of an AP port ranges from 1 to the number of AP ports supported by the device.

The ID of an SVI is the VID of the VLAN corresponding to this SVI.

❖ Configuring Interfaces Within a Range

You can run the **interface range** command in global configuration mode to configure multiple interfaces at a time.

Attributes configured in interface configuration mode apply to all these interfaces.

The **interface range** command can be used to specify several interface ranges.

The **macro** parameter is used to configure the macro corresponding to a range. For details, see "Configuring Macros of Interface Ranges."

Ranges can be separated by commas (,).

The types of interfaces within all ranges specified in a command must be the same.

Pay attention to the format of the **range** parameter when you run the **interface range** command.

The following interface range formats are valid:

- **FastEthernet** device/slot/{first port} - {last port};
- **GigabitEthernet** device/slot/{first port} - {last port};
- **TenGigabitEthernet** device/slot/{first port} - {last port};
- **FortyGigabitEthernet** device/slot/{first port} - {last port};
- **AggregatePort** *Aggregate-port ID* (The AP ID ranges from 1 to the maximum number of AP ports supported by the device.)
- **vlan** vlan-ID-vlan-ID (The VLAN ID ranges from 1 to 4,094.)



- **Loopback** loopback-ID (The loopback ID ranges from 1 to 2,147,483,647.)
- **Tunnel** tunnel-ID (The tunnel ID ranges from 0 to the maximum number of tunnel interfaces supported by the device minus 1.)

Interfaces in an interface range must be of the same type, namely, FastEthernet, GigabitEthernet, AggregatePort, or SVI.

❖ Configuring Macros of Interface Ranges

You can define some macros to replace the interface ranges. Before using the **macro** parameter in the **interface range** command, you must first run the **define interface-range** command in global configuration mode to define these macros.

Run the **no define interface-range macro_name** command in global configuration mode to delete the configured macros.

1.3.2 Interface Description and Administrative Status

You can configure a name for an interface to identify the interface and help you remember the functions of the interface.

You can enter interface configuration mode to enable or disable an interface.

Working Principle

❖ Interface Description

You can configure the name of an interface based on the purpose of the interface. For example, if you want to assign GigabitEthernet 1/1 for exclusive use by user A, you can describe the interface as "Port for User A."

❖ Interface Administrative Status

You can configure the administrative status of an interface to disable the interface as required. If the interface is disabled, no frame will be received or sent on this interface, and the interface will lose all its functions. You can enable a disabled interface by configuring the administrative status of the interface. Two types of interface administrative status are defined: Up and Down. The administrative status of an interface is Down when the interface is disabled, and Up when the interface is enabled.

1.3.3 MTU

You can configure the MTU of a port to limit the length of a frame that can be received or sent over this port.

Working Principle

When a large amount of data is exchanged over a port, frames greater than the standard Ethernet frame may exist. This type of frame is called jumbo frame. The MTU is the length of the valid data segment in a frame. It does not include the Ethernet encapsulation overhead.

If a port receives or sends a frame with a length greater than the MTU, this frame will be discarded.

The MTU ranges from 64 bytes to 9,216 bytes, at a step of four bytes. The default MTU is 1500 bytes.

-
- The **mtu** command takes effect only on a physical or AP port.
-

1.3.4 Bandwidth

Working Principle

The **bandwidth** command can be configured so that some routing protocols (for example, OSPF) can calculate the route metric and the Resource Reservation Protocol (RSVP) can calculate the reserved bandwidth. Modifying the interface bandwidth will not affect the data transmission rate of the physical port.

-
- The **bandwidth** command is a routing parameter, and does not affect the bandwidth of a physical link.
-

1.3.5 Load Interval

Working Principle

You can run the **load-interval** command to specify the interval for load calculation of an interface. Generally, the interval is 10s.

1.3.6 Carrier Delay

Working Principle

The carrier delay refers to the delay after which the data carrier detect (DCD) signal changes from Down to Up or from Up to Down. If the DCD status changes during the delay, the system will ignore this change to avoid negotiation at the upper data link layer. If this parameter is set to a great value, nearly every DCD change is not detected. On the contrary, if the parameter is set to 0, every DCD signal change will be detected, resulting in poor stability.

-
- If the DCD carrier is interrupted for a long time, the carrier delay should be set to a smaller value to accelerate convergence of the topology or route. On the contrary, if the DCD carrier interruption time is shorter than the topology or route convergence time, the carrier delay should be set to a greater value to avoid topology or route flapping.
-

1.3.7 Link Trap Policy

You can enable or disable the link trap function on an interface.

Working Principle

When the link trap function on an interface is enabled, the Simple Network Management Protocol (SNMP) sends link traps when the link status changes on the interface.

1.3.8 Interface Index Persistence

Like the interface name, the interface index also identifies an interface. When an interface is created, the system automatically assigns a unique index to the interface. The index of an interface may change after the device is restarted. You can enable the interface index persistence function so that the interface index remains unchanged after the device is restarted.

Working Principle

After interface index persistence is enabled, the interface index remains unchanged after the device is restarted.

1.3.9 Routed Port

Working Principle

A physical port on a L3 device can be configured as a routed port, which functions as the gateway interface for L3 switching. The routed port cannot be used for L2 switching. You can run the **no switchport** command to change a switch port to a routed port and assign an IP address to this port to set up a route. Note that you must delete all L2 features of a switch port before running the **no switchport** command.

1.3.10 L3 AP Port

Working Principle

Like a L3 routed port, you can run the **no switchport** command to change a L2 AP port into a L3 AP port on a L3 device, and then assign an IP address to this AP port to set up a route. Note that you must delete all L2 features of the AP port before running the **no switchport** command.

-
- A L2 AP port with one or more member ports cannot be configured as a L3 AP port. Similarly, a L3 AP port with one or more member ports cannot be changed to a L2 AP port.
-

1.3.11 Interface Speed, Duplex Mode, Flow Control Mode, and Auto Negotiation Mode

You can configure the interface speed, duplex mode, flow control mode, and auto negotiation mode of an Ethernet physical port or AP port.

Working Principle

❖ Speed

Generally, the speed of an Ethernet physical port is determined through negotiation with the peer device. The negotiated speed can be any speed within the interface capability. You can also configure any speed within the interface capability for the Ethernet physical port.

When you configure the speed of an AP port, the configuration takes effect on all of its member ports. (All these member ports are Ethernet physical ports.)

❖ Duplex Mode

- The duplex mode of an Ethernet physical port or AP port can be configured as follows:
- Set the duplex mode of the interface to full-duplex so that the interface can receive packets while sending packets.
- Set the duplex mode of the interface to half-duplex so that the interface can receive or send packets at a time.
- Set the duplex mode of the interface to auto-negotiation so that the duplex mode of the interface is determined through auto negotiation between the local interface and peer interface.
- When you configure the duplex mode of an AP port, the configuration takes effect on all of its member ports. (All these member ports are Ethernet physical ports.)

❖ Flow Control

Two flow control modes are defined for an interface:

- Symmetric flow control mode: Generally, after flow control is enabled on an interface, the interface processes the received flow control frames, and sends the flow control frames when congestion occurs on the interface. The received and sent flow control frames are processed in the same way. This is called symmetric flow control mode.
- Asymmetric flow control mode: In some cases, an interface on a device is expected to process the received flow control frames to ensure that no packet is discarded due to congestion, and not to send the flow control frames to avoid decreasing the network speed. In this case, you

need to configure asymmetric flow control mode to separate the procedure for receiving flow control frames from the procedure for sending flow control frames.

- When you configure the flow control mode of an AP port, the configuration takes effect on all of its member ports. (All these member ports are Ethernet physical ports.)

As shown in Figure 1-4, Port A of the device is an uplink port, and Ports B, C and D are downlink ports. Assume that Port A is enabled with the functions of sending and receiving flow control frames. Port B and Port C are connected to different slow networks. If a large amount of data is sent on Port B and Port C, Port B and Port C will be congested, and consequently congestion occurs in the inbound direction of Port A. Therefore, Port A sends flow control frames. When the uplink device responds to the flow control frames, it reduces the data flow sent to Port A, which indirectly slows down the network speed on Port D. At this time, you can disable the function of sending flow control frames on Port A to ensure the bandwidth usage of the entire network.

Figure 1-4

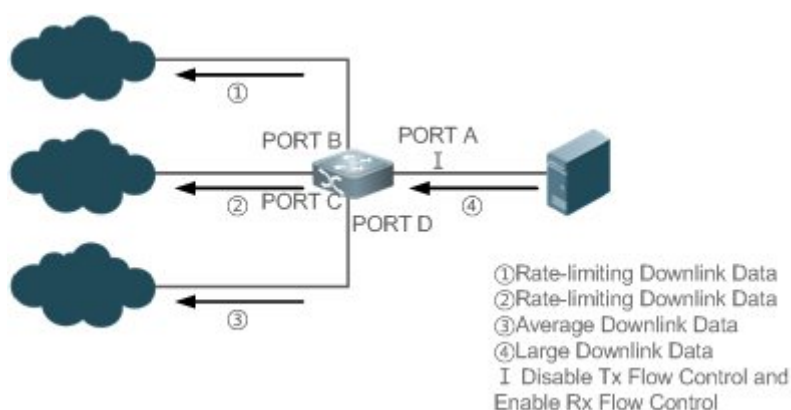

❖ Auto Negotiation Mode

- The auto negotiation mode of an interface can be On or Off. The auto negotiation state of an interface is not completely equivalent to the auto negotiation mode. The auto negotiation state of an interface is jointly determined by the interface speed, duplex mode, flow control mode, and auto negotiation mode.
- When you configure the auto negotiation mode of an AP port, the configuration takes effect on all of its member ports. (All these member ports are Ethernet physical ports.)

! Generally, if one of the interface speed, duplex mode, and flow control mode is set to auto, or the auto negotiation mode of an interface is On, the auto negotiation state of the interface is On, that is, the auto negotiation function of the interface is enabled. If none of the interface speed, duplex mode, and flow control mode is set to auto, and the auto negotiation mode of an interface is Off, the auto negotiation state of the interface is Off, that is, the auto negotiation function of the interface is disabled.

! For a 100M fiber port, the auto negotiation function is always disabled, that is, the auto negotiation state of a 100M fiber port is always Off. For a Gigabit copper port, the auto

negotiation function is always enabled, that is, the auto negotiation state of a Gigabit copper port is always On.

1.3.12 Automatic Module Detection

If the interface speed is set to auto, the interface speed can be automatically adjusted based on the type of the inserted module.

Working Principle

Currently, the automatic module detection function can be used to detect only the SFP and SFP+ modules. The SFP is a Gigabit module, whereas SFP+ is a 10 Gigabit module. If the inserted module is SFP, the interface works in Gigabit mode. If the inserted module is SFP+, the interface works in 10 Gigabit mode.

! The automatic module detection function takes effect only when the interface speed is set to auto.

1.3.13 Protected Port

In some application environments, it is required that communication be disabled between some ports. For this purpose, you can configure some ports as protected ports. You can also disable routing between protected ports.

Working Principle

❖ Protected Port

After ports are configured as protected ports, protected ports cannot communicate with each other, but can communicate with non-protected ports.

Protected ports work in either of the two modes. In the first mode, L2 switching is blocked but routing is allowed between protected ports. In the second mode, both L2 switching and routing are blocked between protected ports. If a protected port supports both modes, the first mode is used by default.

When two protected port are configured as a pair of mirroring ports, frames sent or received by the source port can be mirrored to the destination port.

Currently, only an Ethernet physical port or AP port can be configured as a protected port. When an AP port is configured as a protected port, all of its member ports are configured as protected ports.

❖ Blocking L3 Routing Between Protected Ports

By default, L3 routing between protected ports is not blocked. In this case, you can run the **protected-ports route-deny** command to block routing between protected ports.

1.3.14 Port Errdisable Recovery

Some protocols support the port errdisable recovery function to ensure security and stability of the network. For example, in the port security protocol, when you enable port security and configure the maximum number of security addresses on the port, a port violation event is generated if the number of addresses learned on this port exceeds the maximum number of security addresses. Other protocols, such as the Spanning Tree Protocol (STP), DOT1X, and REUP, support the similar functions, and a violating port will be automatically shut down to ensure security.

Working Principle

After a port is shut down due to a violation, you can run the **errdisable recovery** command in global configuration mode to recovery all the ports in errdisable state and enable these ports. You can manually recover a port, or automatically recover a port at a scheduled time.

1.3.15 Split and Combination of the 40G Port

Working Principle

The 40G Ethernet port is a high-bandwidth port. It is mainly used on devices at the convergence layer or core layer to increase the port bandwidth. 40G port split means that a 40G port is split into four 10G ports. At this time, the 40G port becomes unavailable, and the four 10G ports forward data independently. 40G port combination means that four 10G ports are combined into a 40G port. At this time, the four 10G ports become unavailable, and only the 40G port forwards data. You can flexibly adjust the bandwidth by combining or splitting ports.

1.4 Configuration

Configuration	Description and Command
Performing Basic Configurations	(Optional) It is used to manage interface configurations, for example, creating/deleting an interface, or configuring the interface description.
	interface Creates an interface and enters configuration mode of the created interface or a specified interface.
	interface range Enters an interface range, creates these interfaces (if not created), and enters interface configuration mode.
	define interface-range Creates a macro to specify an interface range.
	snmp-server if-index persist Enables the interface index persistence function so that the interface index remains unchanged after the device is restarted.

Configuration	Description and Command	
	description	Configures the interface description of up to 80 characters in interface configuration mode.
	snmp trap link-status	Configures whether to send the link traps of the interface.
	shutdown	Shuts down an interface in interface configuration mode.
	split interface	Splits a 40G port in global configuration mode.
Configuring Interface Attributes	(Optional) It is used to configure interface attributes.	
	bandwidth	Configures the bandwidth of an interface in interface configuration mode.
	carrier-delay	Configures the carrier delay of an interface in interface configuration mode.
	load-interval	Configures the interval for load calculation of an interface.
	duplex	Configures the duplex mode of an interface.
	flowcontrol	Enables or disables flow control of an interface.
	mtu	Configures the MTU of an interface.
	negotiation mode	Configures the auto negotiation mode of an interface.
	speed	Configures the speed of an interface.
	switchport	Configures an interface as a L2 interface in interface configuration mode. (Run the no switchport command to configure an interface as a L3 interface.)
	switchport protected	Configures a port as a protected port.
	protected-ports route-deny	Blocks L3 routing between protected ports in global configuration mode.
errdisable recovery	Recovers a port in errdisable state in global configuration mode.	

1. 4. 1 Performing Basic Configurations

[Configuration Effect](#)

- Create a specified logical interface and enter configuration mode of this interface, or enter configuration mode of an existing physical or logical interface.
- Create multiple specified logical interfaces and enter interface configuration mode, or enter configuration mode of multiple existing physical or logical interfaces.
- The interface indexes remain unchanged after the device is restarted.
- Configure the interface description so that users can directly learn information about the interface.
- Enable or disable the link trap function of an interface.

- Enable or disable an interface.
- Split a 40G port or combine four 10G ports into a 40G port.

Notes

- The **no** form of the command can be used to delete a specified logical interface or logical interfaces in a specified range, but cannot be used to delete a physical port or physical ports in a specified range.
- The **default** form of the command can be used in interface configuration mode to restore default settings of a specified physical or logical interface, or interfaces in a specified range.

Configuration Steps

❖ Configuring a Specified Interface

- Optional.
- Run this command to create a logical interface or enter configuration mode of a physical port or an existing logical interface.

Command	<code>interface interface-type interface-number</code>
Parameter Description	<i>interface-type interface-number</i> : Indicates the type and number of the interface. The interface can be an Ethernet physical port, AP port, SVI, or loopback interface.
Defaults	N/A
Command Mode	Global configuration mode
Usage Guide	<ul style="list-style-type: none"> ➤ If a logical interface is not created yet, run this command to create this interface and enter configuration mode of this interface. ➤ For a physical port or an existing logical interface, run this command to enter configuration mode of this interface. ➤ Use the no form of the command to delete a specified logical interface. ➤ Use the default form of the command to restore default settings of the interface in interface configuration mode.

❖ Configuring Interfaces Within a Range

- Optional.
- Run this command to create multiple logical interfaces or enter configuration mode of multiple physical port or existing logical interfaces.

Command	<code>interface range { port-range macro macro_name }</code>
Parameter Description	<i>port-range</i> : Indicates the type and ID range of interfaces. These interfaces can be Ethernet physical ports, AP ports, SVIs, or loopback interfaces. <i>macro_name</i> : Indicates the name of the interface range macro.

Defaults	N/A
Command Mode	Global configuration mode
Usage Guide	<ul style="list-style-type: none"> ➤ If logical interfaces are not created yet, run this command to create these interfaces and enter interface configuration mode. ➤ For multiple physical ports or existing logical interfaces, run this command to enter interface configuration mode. ➤ Use the default form of the command to restore default settings of these interfaces in interface configuration mode. ➤ Before using a macro, run the define interface-range command to define the interface range as a macro name in global configuration mode, and then run the interface range macro <i>macro_name</i> command to apply the macro.

❖ Configuring Interface Index Persistence

- Optional.
- Run this command when the interface indexes must remain unchanged after the device is restarted.

Command	snmp-server if-index persist
Parameter Description	N/A
Defaults	By default, interface index persistence is disabled.
Command Mode	Global configuration mode
Usage Guide	After this command is executed, current indexes of all interfaces will be saved, and the indexes remain unchanged after the device is restarted. You can use the no or default form of the command to disable the interface index persistence function.

❖ Configuring the Description of an Interface

- Optional.
- Run this command to configure the description of an interface.

Command	description <i>string</i>
Parameter Description	<i>string</i> : Indicates a string of up to 80 characters.
Defaults	By default, no description is configured.
Command Mode	Interface configuration mode
Usage Guide	This command is used to configure the description of an interface. You can use the no or default form of the command to delete the description of an interface.-

❖ Configuring the Link Trap Function of an Interface

- Optional.
- Run this command to obtain the link traps through SNMP.

Command	snmp trap link-status
Parameter Description	N/A
Defaults	By default, the link trap function is enabled.
Command Mode	Interface configuration mode
Usage Guide	This command is used to configure the link trap function on an interface. When this function is enabled, the SNMP sends link traps when the link status changes on the interface. You can use the no or default form of the command to disable the link trap function.

❖ Configuring the Administrative Status of an Interface

- Optional.
- Run this command to enable or disable an interface.
- An interface cannot send or receive packets after it is disabled.

Command	Shutdown
Parameter Description	N/A
Defaults	By default, the administrative status of an interface is Up.
Command Mode	Interface configuration mode
Usage Guide	You can run the shutdown command to disable an interface, or the no shutdown command to enable an interface. In some cases, for example, when an interface is in errdisable state, you cannot run the no shutdown command on an interface. You can use the no or default form of the command to enable the interface.

❖ Splitting a 40G Port or Combining Four 10G Ports into a 40G Port

- Optional.
- Run this command to split a 40G port or combine four 10G ports into a 40G port.

Command	[no] split interface <i>interface-type interface-number</i>
Parameter Description	<i>interface-type interface-number</i> . Indicates the type and number of a port. The port must be a 40G port.
Defaults	By default, the ports are combined.
Command Mode	Global configuration mode
Usage Guide	You can run the split command to split a 40G port, or the no split command to combine the split 40G port.

After this command is configured, you generally need to restart the line card or the entire device so that the configuration can take effect.

Verification

❖ Configuring a Specified Interface

- Run the **interface** command. If you can enter interface configuration mode, the configuration is successful.
- For a logical interface, after the **no interface** command is executed, run the **show running** or **show interfaces** command to check whether the logical interface exists. If not, the logical interface is deleted.
- After the **default interface** command is executed, run the **show running** command to check whether the default settings of the corresponding interface are restored. If yes, the operation is successful.

❖ Configuring Interfaces Within a Range

- Run the **interface range** command. If you can enter interface configuration mode, the configuration is successful.
- After the **default interface range** command is executed, run the **show running** command to check whether the default settings of the corresponding interfaces are restored. If yes, the operation is successful.

❖ Configuring Interface Index Persistence

- After the **snmp-server if-index persist** command is executed, run the **write** command to save the configuration, restart the device, and run the **show interface** command to check the interface index. If the index of an interface remains the same after the restart, interface index persistence is enabled.

❖ Configuring the Link Trap Function of an Interface

- Remove and then insert the network cable on a physical port, and enable the SNMP server. If the SNMP server receives link traps, the link trap function is enabled.
- Run the **no** form of the **snmp trap link-status** command. Remove and then insert the network cable on a physical port. If the SNMP server does not receive link traps, the link trap function is disabled.

❖ Configuring the Administrative Status of an Interface

- Insert the network cable on a physical port, enable the port, and run the **shutdown** command on this port. If the syslog is displayed on the Console indicating that the state of the port changes to Down, and the indicator on the port is off, the port is disabled. Run the **show interfaces** command, and verify that the interface state changes to Administratively Down. Then, run the **no shutdown** command to enable the port. If the syslog is displayed on the Console indicating that the state of the port changes to Up, and the indicator on the port is on, the port is enabled.
- ❖ Splitting a 40G Port or Combining Four 10G Ports into a 40G Port
- Run the **split** command on a 40G port in global configuration mode. Verify that the related syslog is displayed on the Console. Run the **write** command to save the configuration, and restart the device or line card according to the method described in the syslog. Run the **show run** command, and verify that the "!merged to interface" message is no longer displayed in the information related to the four 10G ports, into which the 40G port is split. In addition, the four 10G ports can be configured as L2 or L3 ports, but the split 40G port cannot be configured as a L2 or L3 port. Run the **show run** command, and verify that the "!splited into interface" message is displayed in the information related to the 40G port.
- Run the **no split** command on a split 40G port. Verify that the related syslog is displayed on the Console. Run the **write** command to save the configuration, and restart the device or line card according to the method described in the syslog. Run the **show run** command, and verify that the "!merged to interface" message is displayed in the information related to the four 10G ports that are combined into a 40G port. In addition, the four 10G ports cannot be configured as L2 or L3 ports, but the combined 40G port can be configured as a L2 or L3 port.

**Configurati
on Example**

❖ Configuring Basic Attributes of Interfaces

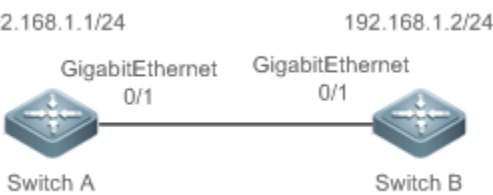
<p>Scenario Figure 1-5</p>	
<p>Configuratio n Steps</p>	<ul style="list-style-type: none"> ➤ Connect two devices through the switch ports. ➤ Configure an SVI respectively on two devices, and assign IP addresses from a network segment to the two SVIs. ➤ Enable interface index persistence on the two devices. ➤ Enable the link trap function on the two devices. ➤ Configure the interface administrative status on the two devices.
<p>A</p>	<pre>A# configure terminal</pre>

	<pre>A(config)# snmp server if index persist A(config)# interface vlan 1 A(config if VLAN 1)# ip address 192.168.1.1 255.255.255.0 A(config if VLAN 1)# exit A(config)# interface gigabitethernet 0/1 A(config if GigabitEthernet 0/1)# snmp trap link status A(config if GigabitEthernet 0/1)# shutdown A(config if GigabitEthernet 0/1)# end A# write</pre>
B	<pre>B# configure terminal B(config)# snmp server if index persist B(config)# interface vlan 1 B(config if VLAN 1)# ip address 192.168.1.2 255.255.255.0 B(config if VLAN 1)# exit B(config)# interface gigabitethernet 0/1 B(config if GigabitEthernet 0/1)# snmp trap link status B(config if GigabitEthernet 0/1)# shutdown B(config if GigabitEthernet 0/1)# end B# write</pre>
Verification	<p>Perform verification on Switch A and Switch B as follows:</p> <ul style="list-style-type: none"> ➤ Run the shutdown command on port GigabitEthernet 0/1, and check whether GigabitEthernet 0/1 and SVI 1 are Down. ➤ Run the shutdown command on port GigabitEthernet 0/1, and check whether a trap indicating that this interface is Down is sent. ➤ Restart the device, and check whether the index of GigabitEthernet 0/1 is the same as that before the restart.
A	<pre>A# show interfaces gigabitEthernet 0/1 Index(dec):1 (hex):1 GigabitEthernet 0/1 is administratively down , line protocol is DOWN Hardware is GigabitEthernet, address is 08c6.b365.de9b (bia 08c6.b365.de9b) Interface address is: no ip address</pre>

```
MTU 1500 bytes, BW 1000000 Kbit
Encapsulation protocol is Bridge, loopback not set
Keepalive interval is 10 sec , set
Carrier delay is 2 sec
Rxload is 1/255, Txload is 1/255
Queue      Transmitted packets      Transmitted bytes      Dropped
packets      Dropped bytes
0          0          0          0
0          1          0          0
0          2          0          0
0          3          0          0
0          4          0          0
0          5          0          0
0          6          0          0
0          7          4          440
0

Switchport attributes:
  interface's description:""
  lastchange time:0 Day:20 Hour:15 Minute:22 Second
  Priority is 0

  admin speed is AUTO, oper speed is Unknown
  flow control admin status is OFF, flow control oper status is Unknown
  admin negotiation mode is OFF, oper negotiation state is ON
  Storm Control: Broadcast is OFF, Multicast is OFF, Unicast is OFF
Port type: access

Vlan id: 1

10 seconds input rate 0 bits/sec, 0 packets/sec
```

	<pre> 10 seconds output rate 0 bits/sec, 0 packets/sec 4 packets input, 408 bytes, 0 no buffer, 0 dropped Received 0 broadcasts, 0 runts, 0 giants 0 input errors, 0 CRC, 0 frame, 0 overrun, 0 abort 4 packets output, 408 bytes, 0 underruns , 0 dropped 0 output errors, 0 collisions, 0 interface resets A# show interfaces vlan 1 Index(dec):4097 (hex):1001 VLAN 1 is UP , line protocol is DOWN Hardware is VLAN, address is 08c6.b322.33af (bia 08c6.b322.33af) Interface address is: 192.168.1.1/24 ARP type: ARPA, ARP Timeout: 3600 seconds MTU 1500 bytes, BW 1000000 Kbit Encapsulation protocol is Ethernet II, loopback not set Keepalive interval is 10 sec , set Carrier delay is 2 sec Rxload is 0/255, Txload is 0/255 </pre>
<p>B</p>	<pre> B# show interfaces gigabitEthernet 0/1 Index(dec):1 (hex):1 GigabitEthernet 0/1 is administratively down , line protocol is DOWN Hardware is GigabitEthernet Interface address is: no ip address, address is 08c6.b365.de9b (bia 08c6.b365.de9b) MTU 1500 bytes, BW 1000000 Kbit Encapsulation protocol is Bridge, loopback not set Keepalive interval is 10 sec , set Carrier delay is 2 sec Rxload is 1/255, Txload is 1/255 Queue Transmitted packets Transmitted bytes Dropped packets Dropped bytes 0 0 0 0 0 1 0 0 0 </pre>

```
0
  2          0          0          0
0
  3          0          0          0
0
  4          0          0          0
0
  5          0          0          0
0
  6          0          0          0
0
  7          4          440         0
0

Switchport attributes:
  interface's description:""
  lastchange time:0 Day:20 Hour:15 Minute:22 Second
  Priority is 0

  admin duplex mode is AUTO, oper duplex is Unknown
  admin speed is AUTO, oper speed is Unknown
  flow control admin status is OFF, flow control oper status is Unknown
  admin negotiation mode is OFF, oper negotiation state is ON
  Storm Control: Broadcast is OFF, Multicast is OFF, Unicast is OFF
Port type: access
  Vlan id: 1
  10 seconds input rate 0 bits/sec, 0 packets/sec
  10 seconds output rate 0 bits/sec, 0 packets/sec
  4 packets input, 408 bytes, 0 no buffer, 0 dropped
  Received 0 broadcasts, 0 runts, 0 giants
  0 input errors, 0 CRC, 0 frame, 0 overrun, 0 abort
  4 packets output, 408 bytes, 0 underruns , 0 dropped
  0 output errors, 0 collisions, 0 interface resets
B# show interfaces vlan 1
Index(dec):4097 (hex):1001
```

```
VLAN 1 is UP , line protocol is DOWN
Hardware is VLAN, address is 08c6.b322.33af (bia 08c6.b322.33af)
Interface address is: 192.168.1.2/24
ARP type: ARPA, ARP Timeout: 3600 seconds
MTU 1500 bytes, BW 1000000 Kbit
Encapsulation protocol is Ethernet II, loopback not set
Keepalive interval is 10 sec , set
Carrier delay is 2 sec
Rxload is 0/255, Txload is 0/255
```

1.4.2 Configuring Interface Attributes

Configurati on Effect

- Enable the device to connect and communicate with other devices through the switch port or routed port.
- Adjust various interface attributes on the device.

Configurati on Steps

❖ Configuring a Routed Port

- Optional.
- Run this command to configure a port as a L3 routed port.
- After a port is configured as a L3 routed port, L2 protocols running on the port do not take effect.
- This command is applicable to a L2 switch port.

Command	no switchport
Parameter Description	N/A
Defaults	By default, an Ethernet physical port is a L2 switch port.
Command Mode	Interface configuration mode
Usage Guide	On a L3 device, you can run this command to configure a L2 switch port as a L3 routed port. You can run the switchport command to change a L3 routed port into a L2 switch port.

❖ Configuring a L3 AP Port

- Optional.
- Run the **no switchport** command in interface configuration mode to configure a L2 AP port as a L3 AP port. Run the **switchport** command to configure a L3 AP port as a L2 AP port.
- After a port is configured as a L3 routed port, L2 protocols running on the port do not take effect.
- This command is applicable to a L2 AP port.

Command	no switchport
Parameter	N/A
Description	
Defaults	By default, an AP port is a L2 AP port.
Command Mode	Interface configuration mode
Usage Guide	After entering configuration mode of a L2 AP port on a L3 device, you can run this command to configure a L2 AP port as a L3 AP port. After entering configuration mode of a L3 AP port, you can run the switchport command to change a L3 AP port into a L2 AP port.

❖ Configuring the Speed of an Interface

- Optional.
- Port flapping may occur if the configured speed of a port changes.
- This command is applicable to an Ethernet physical port or AP port.

Command	speed [10 100 1000 10G 40G auto]
Parameter	10 : Indicates that the speed of the interface is 10 Mbps.
Description	100 : Indicates that the speed of the interface is 100 Mbps. 1000 : Indicates that the speed of the interface is 1000 Mbps. 10G : Indicates that the speed of the interface is 10 Gbps. auto : Indicates that the speed of the interface automatically adapts to the actual condition.
Defaults	By default, the speed of an interface is auto.
Command Mode	Interface configuration mode
Usage Guide	If an interface is an AP member port, the speed of this interface is determined by the speed of the AP port. When the interface exits the AP port, it uses its own speed configuration. You can run show interfaces to display the speed configurations. The speed options available to an interface vary with the type of the interface. For example, you cannot set the speed of an SFP interface to 10 Mbps. <div style="border: 1px dashed black; padding: 5px; margin-top: 10px;"> <p>! The speed of a 40G physical port can only be set to auto.</p> </div>

❖ Configuring the Duplex Mode of an Interface

- Optional.
- Port flapping may occur if the configured duplex mode of a port changes.
- This command is applicable to an Ethernet physical port or AP port.

Command	duplex { auto full half }
Parameter Description	auto: Indicates automatic switching between full duplex and half duplex. full: Indicates full duplex. half: Indicates half duplex.
Defaults	By default, the duplex mode of an interface is auto.
Command Mode	Interface configuration mode
Usage Guide	The duplex mode of an interface is related to the interface type. You can run show interfaces to display the configurations of the duplex mode.

❖ Configuring the Flow Control Mode of an Interface

- Optional.
- Generally, the flow control mode of an interface is off by default. For some products, the flow control mode is on by default.
- After flow control is enabled on an interface, the flow control frames will be sent or received to adjust the data volume when congestion occurs on the interface.
- Port flapping may occur if the configured flow control mode of a port changes.
- This command is applicable to an Ethernet physical port or AP port.

Command	flowcontrol { auto off on receive { auto off on } send { auto off on } }
Parameter Description	auto: Indicates automatic flow control. off: Indicates that flow control is disabled. on: Indicates that flow control is enabled. receive: Indicates the receiving direction of asymmetric flow control. send: Indicates the sending direction of asymmetric flow control.
Defaults	By default, flow control is disabled on an interface.
Command Mode	Interface configuration mode
Usage Guide	Some products do not support asymmetric flow control, and therefore do not support the send and receive keywords. You can run the show interfaces command to check whether the configuration takes effect.

❖ Configuring the Auto Negotiation Mode of an Interface

- Optional.
- Port flapping may occur if the configured auto negotiation mode of a port changes.

- This command is applicable to an Ethernet physical port or AP port.

Command	negotiation mode { on off }
Parameter Description	on: Indicates that the auto negotiation mode is on. off: Indicates that the auto negotiation mode is off.
Defaults	By default, the auto negotiation mode is off.
Command Mode	Interface configuration mode
Usage Guide	N/A

❖ Configuring the MTU of an Interface

- Optional.
- You can configure the MTU of a port to limit the length of a frame that can be received or sent over this port.
- This command is applicable to an Ethernet physical port or SVI.

Command	mtu num
Parameter Description	num: 64 - 9216
Defaults	By default, the MTU of an interface is 1500 bytes.
Command Mode	Interface configuration mode
Usage Guide	This command is used to configure the interface MTU, that is, the maximum length of a data frame at the link layer. Currently, you can configure MTU for only a physical port or an AP port that contains one or more member ports.

❖ Configuring the Bandwidth of an Interface

- Optional.
- Generally, the bandwidth of an interface is the same as the speed of the interface.

Command	bandwidth kilobits
Parameter Description	kilobits: The value ranges from 1 to the maximum speed which Qtech devices can support. The unit is kilo bits.
Defaults	Generally, the bandwidth of an interface matches the type of the interface. For example, the default bandwidth of a gigabit Ethernet physical port is 1,000,000, and that of a 10G Ethernet physical port is 10,000,000.
Command Mode	Interface configuration mode
Usage Guide	N/A

❖ Configuring the Carrier Delay of an Interface

- Optional.

- If the configured carrier delay is long, it takes a long time to change the protocol status when the physical status of an interface changes. If the carrier delay is set to 0, the protocol status changes immediately after the physical status of an interface changes.

Command	carrier-delay {[milliseconds] <i>num</i> up [milliseconds] <i>num</i> down [milliseconds] <i>num</i> }
Parameter Description	<i>num</i> : The value ranges from 0 to 60. The unit is second. milliseconds : Indicates the carrier delay. The value ranges from 0 to 60,000. The unit is millisecond. Up : Indicates the delay after which the state of the DCD changes from Down to Up. Down : Indicates the delay after which the state of the DCD changes from Up to Down.
Defaults	By default, the carrier delay of an interface is 2s.
Command Mode	Interface configuration mode
Usage Guide	If millisecond is used as the unit, the configured carrier delay must be an integer multiple of 100 milliseconds.

❖ Configuring the Load Interval of an Interface

- Optional.
- The configured load interval affects computation of the average packet rate on an interface. If the configured load interval is short, the average packet rate can accurately reflect the changes of the real-time traffic.

Command	load-interval <i>seconds</i>
Parameter Description	<i>seconds</i> : The value ranges from 5 to 600. The unit is second.
Defaults	By default, the load interval of an interface is 10s.
Command Mode	Interface configuration mode
Usage Guide	N/A

❖ Configuring a Protected Port

- Optional.
- L2 packets cannot be forwarded between protected ports.
- This command is applicable to an Ethernet physical port or AP port.

Command	switchport protected
Parameter Description	N/A
Defaults	By default, no protected port is configured.
Command Mode	Interface configuration mode
Usage Guide	N/A

❖ Blocking L3 Routing Between Protected Ports

- Optional.
- After this command is configured, L3 routing between protected ports are blocked.

Command	protected-ports route-deny
Parameter Description	N/A
Defaults	By default, the function of blocking L3 routing between protected ports is disabled.
Command Mode	Global configuration mode
Usage Guide	By default, L3 routing between protected ports is not blocked. In this case, you can run this command to block routing between protected ports.

❖ Configuring Port Errdisable Recovery

- Optional.
- By default, a port will be disabled and will not be recovered after a violation occurs. After port errdisable recovery is configured, a port in errdisable state will be recovered and enabled.

Command	errdisable recovery [interval time]
Parameter Description	<i>time</i> : Indicates the automatic recovery time. The value ranges from 30 to 86,400. The unit is second.
Defaults	By default, port errdisable recovery is disabled.
Command Mode	Global configuration mode
Usage Guide	By default, a port in errdisable state is not recovered. You can recover the port manually or run this command to automatically recover the port.

Verification

- Run the **show interfaces** command to display the attribute configurations of interfaces.

Command	show interfaces [interface-type interface-number] [description switchport trunk]
Parameter Description	<i>interface-type interface-number</i> : Indicates the type and number of the interface. description : Indicates the interface description, including the link status. switchport : Indicates the L2 interface information. This parameter is effective only for a L2 interface. trunk : Indicates the Trunk port information. This parameter is effective for a physical port or an AP port.
Command Mode	Privileged EXEC mode
Usage Guide	Use this command without any parameter to display the basic interface information.

```
SwitchA#show interfaces GigabitEthernet 0/1
Index(dec):1 (hex):1
GigabitEthernet 0/1 is DOWN , line protocol is DOWN
  Hardware is Broadcom 5464 GigabitEthernet, address is 08c6.b365.de9b
  (bia 08c6.b365.de9b)
  Interface address is: no ip address
  Interface IPv6 address is:
    No IPv6 address
  MTU 1500 bytes, BW 1000000 Kbit
  Encapsulation protocol is Ethernet II, loopback not set
  Keepalive interval is 10 sec , set
  Carrier delay is 2 sec
  Ethernet attributes:
    Last link state change time: 2012 12 22 14:00:48
    Time duration since last link state change: 3 days, 2 hours, 50 minutes,
50 seconds
    Priority is 0
    Admin duplex mode is AUTO, oper duplex is Unknown
    Admin speed is AUTO, oper speed is Unknown
    Flow receive control admin status is OFF, flow send control admin status
is OFF
    Flow receive control oper status is Unknown, flow send control oper
status is Unknown
    Storm Control: Broadcast is OFF, Multicast is OFF, Unicast is OFF
  Bridge attributes:
    Port type: trunk
    Native vlan:1
    Allowed vlan lists:1-4094 //Allowed VLAN list of the Trunk port
    Active vlan lists:1, 3-4 //Active VLAN list (indicating that only
VLAN 1, VLAN 3, and VLAN 4 are created on the device)
  Queueing strategy: FIFO
    Output queue 0/0, 0 drops;
```



```

Input queue 0/75, 0 drops
Rxload is 1/255,Txload is 1/255
5 minutes input rate 0 bits/sec, 0 packets/sec
5 minutes output rate 0 bits/sec, 0 packets/sec
0 packets input, 0 bytes, 0 no buffer, 0 dropped
Received 0 broadcasts, 0 runts, 0 giants
0 input errors, 0 CRC, 0 frame, 0 overrun, 0 abort
0 packets output, 0 bytes, 0 underruns , 0 dropped
0 output errors, 0 collisions, 0 interface resets
    
```

**Configurati
on Example**

❖ **Configuring Interface Attributes**

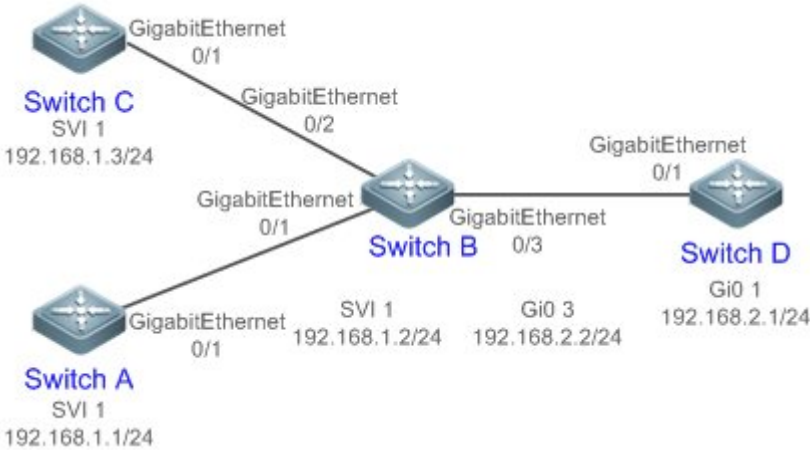
<p>Scenario Figure 1-1</p>	
<p>Configuratio n Steps</p>	<ul style="list-style-type: none"> ➤ On Switch A, configure GigabitEthernet 0/1 as an access mode, and the default VLAN ID is 1. Configure SVI 1, assign an IP address to SVI 1, and set up a route to Switch D. ➤ On Switch B, configure GigabitEthernet 0/1 and GigabitEthernet 0/2 as Trunk ports, and the default VLAN ID is 1. Configure SVI 1, and assign an IP address to SVI 1. Configure GigabitEthernet 0/3 as a routed port, and assign an IP address from another network segment to this port. ➤ On Switch C, configure GigabitEthernet 0/1 as an Access port, and the default VLAN ID is 1. Configure SVI 1, and assign an IP address to SVI 1. ➤ On Switch D, configure GigabitEthernet 0/1 as a routed port, assign an IP address to this port, and set up a route to Switch A.

A	<pre>A# configure terminal A(config)# interface GigabitEthernet 0/1 A(config if GigabitEthernet 0/1)# switchport mode access A(config if GigabitEthernet 0/1)# switchport access vlan 1 A(config if GigabitEthernet 0/1)# exit A(config)# interface vlan 1 A(config if VLAN 1)# ip address 192.168.1.1 255.255.255.0 A(config if VLAN 1)# exit A(config)# ip route 192.168.2.0 255.255.255.0 VLAN 1 192.168.1.2</pre>
B	<pre>B# configure terminal B(config)# interface GigabitEthernet 0/1 B(config if GigabitEthernet 0/1)# switchport mode trunk B(config if GigabitEthernet 0/1)# exit B(config)# interface GigabitEthernet 0/2 B(config if GigabitEthernet 0/2)# switchport mode trunk B(config if GigabitEthernet 0/2)# exit B(config)# interface vlan 1 B(config if VLAN 1)# ip address 192.168.1.2 255.255.255.0 B(config if VLAN 1)# exit B(config)# interface GigabitEthernet 0/3 B(config if GigabitEthernet 0/3)# no switchport B(config if GigabitEthernet 0/3)# ip address 192.168.2.2 255.255.255.0 B(config if GigabitEthernet 0/3)# exit</pre>
C	<pre>C# configure terminal C(config)# interface GigabitEthernet 0/1 C(config if GigabitEthernet 0/1)# port group 1 C(config if GigabitEthernet 0/1)# exit C(config)# interface aggregateport 1 C(config if AggregatePort 1)# switchport mode access C(config if AggregatePort 1)# switchport access vlan 1 C(config if AggregatePort 1)# exit C(config)# interface vlan 1</pre>

	<pre>C(config if VLAN 1)# ip address 192.168.1.3 255.255.255.0 C(config if VLAN 1)# exit</pre>
D	<pre>D# configure terminal D(config)# interface GigabitEthernet 0/1 D(config if GigabitEthernet 0/1)# no switchport D(config if GigabitEthernet 0/1)# ip address 192.168.2.1 255.255.255.0 D(config if GigabitEthernet 0/1)# exit A(config)# ip route 192.168.1.0 255.255.255.0 GigabitEthernet 0/1 192.168.2.2</pre>
Verification	<p>Perform verification on Switch A, Switch B, Switch C, and Switch D as follows:</p> <ul style="list-style-type: none"> ➤ On Switch A, ping the IP addresses of interfaces of the other three switches. Verify that you can access the other three switches on Switch A.. ➤ Verify that switch B and Switch D can be pinged mutually. ➤ Verify that the interface status is correct.
A	<pre>A# show interfaces gigabitEthernet 0/1 Index(dec):1 (hex):1 GigabitEthernet 0/1 is UP , line protocol is UP Hardware is GigabitEthernet, address is 08c6.b365.de90 (bia 08c6.b365.de90) Interface address is: no ip address MTU 1500 bytes, BW 100000 Kbit Encapsulation protocol is Ethernet II, loopback not set Keepalive interval is 10 sec , set Carrier delay is 2 sec Ethernet attributes: Last link state change time: 2012 12 22 14:00:48 Time duration since last link state change: 3 days, 2 hours, 50 minutes, 50 seconds Priority is 0 Admin duplex mode is AUTO, oper duplex is Full Admin speed is AUTO, oper speed is 100M Flow control admin status is OFF, flow control oper status is OFF</pre>

	<pre>Admin negotiation mode is OFF, oper negotiation state is ON Storm Control: Broadcast is OFF, Multicast is OFF, Unicast is OFF Bridge attributes: Port-type: access Vlan id: 1 Rxload is 1/255, Txload is 1/255 10 seconds input rate 0 bits/sec, 0 packets/sec 10 seconds output rate 67 bits/sec, 0 packets/sec 362 packets input, 87760 bytes, 0 no buffer, 0 dropped Received 0 broadcasts, 0 runts, 0 giants 0 input errors, 0 CRC, 0 frame, 0 overrun, 0 abort 363 packets output, 82260 bytes, 0 underruns , 0 dropped 0 output errors, 0 collisions, 0 interface resets</pre>
B	<pre>B# show interfaces gigabitEthernet 0/1 Index(dec):1 (hex):1 GigabitEthernet 0/1 is UP , line protocol is UP Hardware is GigabitEthernet, address is 08c6.b365.de91 (bia 08c6.b365.de91) Interface address is: no ip address MTU 1500 bytes, BW 100000 Kbit Encapsulation protocol is Ethernet II, loopback not set Keepalive interval is 10 sec , set Carrier delay is 2 sec Ethernet attributes: Last link state change time: 2012 12 22 14:00:48 Time duration since last link state change: 3 days, 2 hours, 50 minutes, 50 seconds Priority is 0 Admin duplex mode is AUTO, oper duplex is Full Admin speed is AUTO, oper speed is 100M Flow control admin status is OFF, flow control oper status is OFF Admin negotiation mode is OFF, oper negotiation state is ON</pre>

```
Storm Control: Broadcast is OFF, Multicast is OFF, Unicast is OFF
Bridge attributes:
  Port-type: trunk
  Native vlan: 1
  Allowed vlan lists: 1-4094
  Active vlan lists: 1
Rxload is 1/255, Txload is 1/255
10 seconds input rate 0 bits/sec, 0 packets/sec
10 seconds output rate 67 bits/sec, 0 packets/sec
 362 packets input, 87760 bytes, 0 no buffer, 0 dropped
Received 0 broadcasts, 0 runts, 0 giants
 0 input errors, 0 CRC, 0 frame, 0 overrun, 0 abort
 363 packets output, 82260 bytes, 0 underruns , 0 dropped
 0 output errors, 0 collisions, 0 interface resets
```

C

```
C# show interfaces gigabitEthernet 0/1
Index(dec):1 (hex):1
GigabitEthernet 0/1 is UP , line protocol is UP
Hardware is GigabitEthernet, address is 08c6.b365.de92 (bia
08c6.b365.de92)
Interface address is: no ip address
  MTU 1500 bytes, BW 100000 Kbit
  Encapsulation protocol is Ethernet II, loopback not set
  Keepalive interval is 10 sec , set
  Carrier delay is 2 sec
Ethernet attributes:
  Last link state change time: 2012 12 22 14:00:48
  Time duration since last link state change: 3 days, 2 hours, 50 minutes,
50 seconds
  Priority is 0
  Admin duplex mode is AUTO, oper duplex is Full
  Admin speed is AUTO, oper speed is 100M
  Flow control admin status is OFF, flow control oper status is OFF
  Admin negotiation mode is OFF, oper negotiation state is ON
```

```
Storm Control: Broadcast is OFF, Multicast is OFF, Unicast is OFF
Rxload is 1/255, Txload is 1/255
10 seconds input rate 0 bits/sec, 0 packets/sec
10 seconds output rate 67 bits/sec, 0 packets/sec
362 packets input, 87760 bytes, 0 no buffer, 0 dropped
Received 0 broadcasts, 0 runts, 0 giants
0 input errors, 0 CRC, 0 frame, 0 overrun, 0 abort
363 packets output, 82260 bytes, 0 underruns , 0 dropped
0 output errors, 0 collisions, 0 interface resets
```

D

```
D# show interfaces gigabitEthernet 0/1
Index(dec):1 (hex):1
GigabitEthernet 0/1 is UP , line protocol is UP
Hardware is GigabitEthernet, address is 08c6.b365.de93 (bia
08c6.b365.de93)
Interface address is: 192.168.2.1/24
MTU 1500 bytes, BW 100000 Kbit
Encapsulation protocol is Ethernet II, loopback not set
Keepalive interval is 10 sec , set
Carrier delay is 2 sec
Ethernet attributes:
Last link state change time: 2012 12 22 14:00:48
Time duration since last link state change: 3 days, 2 hours, 50 minutes,
50 seconds
Priority is 0
Admin duplex mode is AUTO, oper duplex is Full
Admin speed is AUTO, oper speed is 100M
Flow control admin status is OFF, flow control oper status is OFF
Admin negotiation mode is OFF, oper negotiation state is ON
Storm Control: Broadcast is OFF, Multicast is OFF, Unicast is OFF
Rxload is 1/255, Txload is 1/255
10 seconds input rate 0 bits/sec, 0 packets/sec
10 seconds output rate 67 bits/sec, 0 packets/sec
```

```

362 packets input, 87760 bytes, 0 no buffer, 0 dropped
Received 0 broadcasts, 0 runts, 0 giants
0 input errors, 0 CRC, 0 frame, 0 overrun, 0 abort
363 packets output, 82260 bytes, 0 underruns , 0 dropped
0 output errors, 0 collisions, 0 interface resets

```

1.5 Monitoring

Clearing

Running the **clear** commands may lose vital information and thus interrupt services.

Description	Command
Clears the counters of a specified interface.	clear counters [<i>interface-type interface-number</i>]
Resets the interface hardware.	clear interface <i>interface-type interface-number</i>

Displaying

❖ Displaying Interface Configurations and Status

Description	Command
Displays all the status and configuration information of a specified interface.	show interfaces [<i>interface-type interface-number</i>]
Displays the interface status.	show interfaces [<i>interface-type interface-number</i>] status
Displays the interface errdisable status.	show interfaces [<i>interface-type interface-number</i>] status err-disable
Displays the link status change time and count of a specified port.	show interfaces [<i>interface-type interface-number</i>] link-state-change statistics
Displays the administrative and operational states of switch ports (non-routed ports).	show interfaces [<i>interface-type interface-number</i>] switchport
Displays the description and status of a specified interface.	show interfaces [<i>interface-type interface-number</i>] description
Displays the counters of a specified port, among which the displayed speed may have an error of $\pm 0.5\%$.	show interfaces [<i>interface-type interface-number</i>] counters
Displays the number of packets increased in a load interval.	show interfaces [<i>interface-type interface-number</i>] counters increment
Displays statistics about error packets.	show interfaces [<i>interface-type interface-number</i>] counters error
Displays the packet sending/receiving rate of an interface.	show interfaces [<i>interface-type interface-number</i>] counters rate
Displays a summary of interface information.	show interfaces [<i>interface-type interface-number</i>] counters summary

Description	Command
Displays the bandwidth usage of an interface.	show interfaces [<i>interface-type interface-number</i>] usage

❖ Displaying Optical Module Information

Description	Command
Displays basic information about the optical module of a specified interface.	show interfaces [<i>interface-type interface-number</i>] transceiver
Displays the fault alarms of the optical module on a specified interface. If no fault occurs, "None" is displayed.	show interfaces [<i>interface-type interface-number</i>] transceiver alarm
Displays the optical module diagnosis values of a specified interface.	show interfaces [<i>interface-type interface-number</i>] transceiver diagnosis

2. CONFIGURING MAC ADDRESS

2.1 Overview

A MAC address table contains the MAC addresses, interface numbers and VLAN IDs of the devices connected to the local device.

When a device forwards a packet, it finds an output port from its MAC address table according to the destination MAC address and the VLAN ID of the packet.

After that, the packet is unicast, multicast or broadcast.

- This document covers dynamic MAC addresses, static MAC addresses and filtered MAC addresses. For the management of multicast MAC addresses, please see *Configuring IGMP Snooping Configuration*.

Protocols and Standards

- IEEE 802.3: Carrier sense multiple access with collision detection (CSMA/CD) access method and physical layer specifications
- IEEE 802.1Q: Virtual Bridged Local Area Networks

2.2 Applications

Application	Description
MAC Address Learning	Forward unicast packets through MAC addresses learning.
MAC Address Change Notification	Monitor change of the devices connected to a network device through MAC address change notification.

2.2.1 MAC Address Learning

Scenario

Usually a device maintains a MAC address table by learning MAC addresses dynamically. The operating principle is described as follows:

As shown in the following figure, the MAC address table of the switch is empty. When User A communicates with User B, it sends a packet to the port GigabitEthernet 0/2 of the switch, and the switch learns the MAC address of User A and stores it in the table.

As the table does not contain the MAC address of User B, the switch broadcasts the packet to the ports of all connected devices except User A, including User B and User C.

Figure 2-1 Step 1 of MAC Address Learning

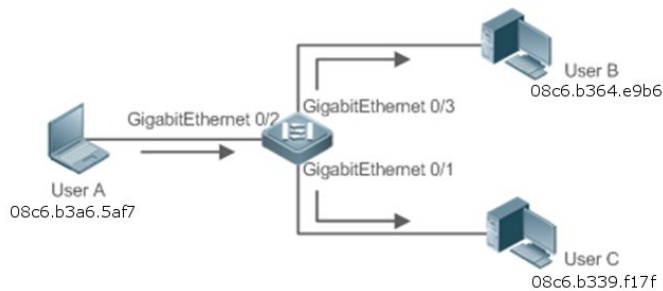

Figure 2-2 MAC Address Table 1

Status	VLAN	MAC address	Interface
Dynamic	1	08c6.b3a6.5af7	GigabitEthernet 0/2

When User B receives the packet, it sends a reply packet to User A through port GigabitEthernet 0/3 on the switch. As the MAC address of User A is already in the MAC address table, the switch send the reply unicast packet to port GigabitEthernet 0/2 port and learns the MAC address of User B. User C does not receive the reply packet from User B to User A.

Figure 2-3 Step 2 of MAC Address Learning



Figure 2-4 MAC Address Table 2

Status	VLAN	MAC address	Interface
Dynamic	1	08c6.b3a6.5af7	GigabitEthernet 0/2
Dynamic	1	08c6.b3a4.e9b6	GigabitEthernet 0/3

Through the interaction between User A and User B, the switch learns the MAC addresses of User A and User B. After that, packets between User A and User B will be exchanged via unicast without being received by User C.

Deployment

t

- With MAC address learning, a layer-2 switch forwards packets through unicast, reducing broadcast packets and network load.

2.2.2 MAC Address Change Notification

MAC address change notification provides a mechanism for the network management system (NMS) to monitor the change of devices connected to a network device.

Scenario

Figure 2-5 MAC Address Change Notification

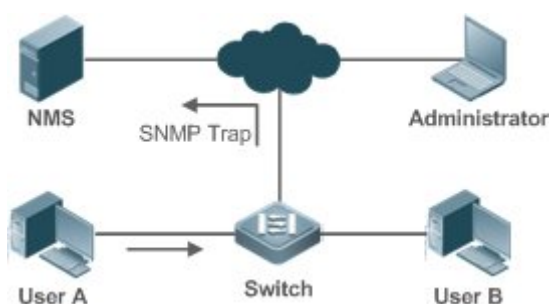

After MAC address change notification is enabled on a device, the device generates a notification message when the device learns a new MAC address or finishes aging a learned MAC address, and sends the message in an SNMP Trap message to a specified NMS.

A notification of adding a MAC address indicates that a new user accesses the network, and that of deleting a MAC address indicates that a user sends no packets within an aging time and usually the user exits the network.

When a network device is connected to a number of devices, a lot of MAC address changes may occur in a short time, resulting in an increase in traffic. To reduce traffic, you may configure an interval for sending MAC address change notifications. When the interval expires, all notifications generated during the interval are encapsulated into a message.

When a notification is generated, it is stored in the table of historical MAC address change notifications. The administrator may know recent MAC address changes by checking the table of notification history even without NMS.

-
- A MAC address change notification is generated only for a dynamic MAC address.
-

Deployment

t

- Enable MAC address change notification on a layer-2 switch to monitor the change of devices connected to a network device.

2.3 Features

Basic Concepts

❖ Dynamic MAC Address

A dynamic MAC address is a MAC address entry generated through the process of MAC address learning by a device.

❖ Address Aging

A device only learns a limited number of MAC addresses, and inactive entries are deleted through address aging.

A device starts aging a MAC address when it learns it. If the device receives no packet containing the source MAC address, it will delete the MAC address from the MAC address table when the time expires.

❖ Forwarding via Unicast

If a device finds in its MAC address table an entry containing the MAC address and the VLAN ID of a packet and the output port is unique, it will send the packet through the port directly.

❖ Forwarding via Broadcast

If a device receives a packet containing the destination address ffff.ffff.ffff or an unidentified destination address, it will send the packet through all the ports in the VLAN where the packet is from, except the input port.

Overview

Feature	Description
Dynamic Address Limit for VLAN	Limit the number of dynamic MAC addresses in a VLAN.
Dynamic Address Limit for Interface	Limit the number of dynamic MAC addresses on an interface.

2.3.1 Dynamic Address Limit for VLAN

Working Principle

The MAC address table with a limited capacity is shared by all VLANs. Configure the maximum number of dynamic MAC addresses for each VLAN to prevent one single VLAN from exhausting the MAC address table space.

A VLAN can only learn a limited number of dynamic MAC addresses after the limit is configured. The packets exceeding the limit are broadcast.

- If the number of learned MAC addresses is greater than the limit, a device will stop learning the MAC addresses from the VLAN and will not start learning again until the number drops below the limit after address aging.
- The MAC addresses copied to a specific VLAN are not subject to the limit.

2.3.2 Dynamic Address Limit for Interface

Working Principle

An interface can only learn a limited number of dynamic MAC addresses after the limit is configured. The packets exceeding the limit are broadcast

- If the number of learned MAC addresses is greater than the limit, a device will stop learning the MAC addresses from the interface and will not start learning again until the number drops below the limit after address aging.

2.4 Configuration

Configuration	Description and Command	
Configuring Dynamic MAC Address	(Optional) It is used to enable MAC address learning.	
	mac-address-learning	Configures MAC address learning globally or on an interface.
	mac-address-table aging-time	Configures an aging time for a dynamic MAC address.
Configuring a Static MAC Address	(Optional) It is used to bind the MAC address of a device with a port of a switch.	
	mac-address-table static	Configures a static MAC address.
Configuring a MAC Address for Packet Filtering	(Optional) It is used to filter packets.	
	mac-address-table filtering	Configures a MAC address for packet filtering.
Configuring MAC Address Change Notification	(Optional) It is used to monitor change of devices connected to a network device.	
	mac-address-table notification	Configures MAC address change notification globally.
	snmp trap mac-notification	Configures MAC address change notification on an interface.

Configuration	Description and Command	
Configuring a Management VLAN for an AP Port	(Optional) It is used to configure a management VLAN for an AP port.	
	<table border="1"> <tr> <td><code>aggregateport-admin vlan</code></td> <td>Configures a management VLAN for an AP port.</td> </tr> </table>	<code>aggregateport-admin vlan</code>
<code>aggregateport-admin vlan</code>	Configures a management VLAN for an AP port.	

2. 4. 1 Configuring Dynamic MAC Address

[Configurati on Effect](#)

Learn MAC addresses dynamically and forward packets via unicast.

[Configurati on Steps](#)

- ❖ Configuring Global MAC Address Learning
 - Optional.
 - You can perform this configuration to disable global MAC address learning.
 - Configuration:

Command	<code>mac-address-learning { enable disable }</code>
Parameter	enable: Enables global MAC address learning.
Description	disable: Disable global MAC address learning.
Defaults	Global MAC address learning is enabled by default.
Command Mode	Global configuration mode
Usage Guide	N/A

- By default, global MAC address learning is enabled. When global MAC address learning is enabled, the MAC address learning configuration on an interface takes effect; when the function is disabled, MAC addresses cannot be learned globally.

- ❖ Configuring MAC Address Learning on Interface
 - Optional.
 - You can perform this configuration to disable MAC address learning on an interface.
 - Configuration:

Command	<code>mac-address-learning</code>
Parameter	N/A
Description	
Defaults	MAC address learning is enabled by default.

Command Mode	Interface configuration mode
Usage Guide	Perform this configuration on a layer-2 interface, for example, a switch port or an AP port.

- By default, MAC address learning is enabled. If DOT1X, IP SOURCE GUARD, or a port security function is configured on a port, MAC address learning cannot be enabled. Access control cannot be enabled on a port with MAC address learning disabled.

❖ Configuring an Aging Time for a Dynamic MAC Address

- Optional.
- Configure an aging time for dynamic MAC addresses.
- Configuration:

Command	<code>mac-address-table aging-time value</code>
Parameter Description	<i>value</i> : Indicates the aging time. The value is either 0 or in the range from 10 to 1000,000.
Defaults	The default is 300s.
Command Mode	Global configuration mode
Usage Guide	If the value is set to 0, MAC address aging is disabled and learned MAC addresses will not be aged.

- The actual aging time may be different from the configured value, but it is not more than two times of the configured value.

Verification

- Check whether a device learns dynamic MAC addresses.
- Run the **show mac-address-table dynamic** command to display dynamic MAC addresses.
- Run the **show mac-address-table aging-time** command to display the aging time for dynamic MAC addresses.

Command	<code>show mac-address-table dynamic [address mac-address] [interface interface-id] [vlan vlan-id]</code>
Parameter Description	address mac-address : Displays the information of a specific dynamic MAC address. interface interface-id : Specifies a physical interface or an AP port. vlan vlan-id : Displays the dynamic MAC addresses in a specific VLAN.
Command Mode	Privileged EXEC mode/Global configuration mode/Interface configuration mode
Usage Guide	N/A
	<pre>Qtech# show mac address table dynamic Vlan MAC Address Type Interface</pre>

1	0000.0000.0001	DYNAMIC	GigabitEthernet 1/1
1	0001.960c.a740	DYNAMIC	GigabitEthernet 1/1
1	0007.95c7.dff9	DYNAMIC	GigabitEthernet 1/1
1	0007.95cf.eee0	DYNAMIC	GigabitEthernet 1/1
1	0007.95cf.f41f	DYNAMIC	GigabitEthernet 1/1
1	0009.b715.d400	DYNAMIC	GigabitEthernet 1/1
1	0050.bade.63c4	DYNAMIC	GigabitEthernet 1/1
Field	Description		
Vlan	Indicates the VLAN where the MAC address resides.		
MAC Address	Indicates a MAC Address.		
Type	Indicates a MAC address type.		
Interface	Indicates the interface where the MAC address resides.		

Command	show mac-address-table aging-time
Parameter Description	N/A
Command Mode	Privileged EXEC mode/Global configuration mode/Interface configuration mode
Usage Guide	N/A
	<pre>Qtech# show mac address table aging time Aging time : 300</pre>

Configurati on Example

❖ Configuring Dynamic MAC Address

Scenario Figure 2-6	
Configuration Steps	<ul style="list-style-type: none"> ➤ Enable MAC address learning on an interface. ➤ Configure the aging time for dynamic MAC addresses to 180s. ➤ Delete all dynamic MAC addresses in VLAN 1 on port GigabitEthernet 0/1.

	<pre>Qtech# configure terminal Qtech(config if GigabitEthernet 0/1)# mac address learning Qtech(config if GigabitEthernet 0/1)# exit Qtech(config)# mac aging time 180 Qtech# clear mac address table dynamic interface GigabitEthernet 0/1 vlan 1</pre>
Verification	<ul style="list-style-type: none">➤ Check MAC address learning on an interface.➤ Display the aging time for dynamic MAC addresses.➤ Display all dynamic MAC addresses in VLAN 1 on port GigabitEthernet 0/1.
	<pre>Qtech# show mac address learning GigabitEthernet 0/1 learning ability: enable Qtech# show mac aging time Aging time : 180 seconds Qtech# show mac address table dynamic interface GigabitEthernet 0/1 vlan 1 Vlan MAC Address Type Interface ----- 1 08c6.b300.1001 STATIC GigabitEthernet 1/1</pre>

Common Errors

Configure MAC address learning on an interface before configuring the interface as a layer-2 interface, for example, a switch port or an AP port.

2.4.2 Configuring a Static MAC Address

Configuration Effect

- Bind the MAC address of a network device with a port of a switch.

Configuration Steps

- ❖ Configuring a Static MAC address
- Optional.
- Bind the MAC address of a network device with a port of a switch.

- Configuration:

Command	mac-address-table static <i>mac-address</i> vlan <i>vlan-id</i> interface <i>interface-id</i>
Parameter Description	address <i>mac-address</i> : Specifies a MAC address. vlan <i>vlan-id</i> : Specifies a VLAN where the MAC address resides. interface <i>interface-id</i> : Specifies a physical interface or an AP port.
Defaults	By default, no static MAC address is configured.
Command Mode	Global configuration mode
Usage Guide	When the switch receives a packet containing the specified MAC address on the specified VLAN, the packet is forwarded to the bound interface.

Verification

- Run the **show mac-address-table static** command to check whether the configuration takes effect.

Command	show mac-address-table static [address <i>mac-address</i>] [interface <i>interface-id</i>] [vlan <i>vlan-id</i>]
Parameter Description	address <i>mac-address</i> : Specifies a MAC address. interface <i>interface-id</i> : Specifies a physical interface or an AP port. vlan <i>vlan-id</i> : Specifies a VLAN where the MAC address resides.
Command Mode	Privileged EXEC mode/Global configuration mode /Interface configuration mode
Usage Guide	N/A
	<pre>Qtech# show mac address table static Vlan MAC Address Type Interface ----- 1 08c6.b300.1001 STATIC GigabitEthernet 1/1 1 08c6.b300.1002 STATIC GigabitEthernet 1/1 1 08c6.b300.1003 STATIC GigabitEthernet 1/1</pre>

Configuration on Example

- ❖ Configuring a Static MAC address

In the above example, the relationship of MAC addresses, VLAN and interfaces is shown in the following table.

Role	MAC Address	VLAN ID	Interface ID
Web Server	00d0.3232.0001	VLAN2	Gi0/10
Database Server	00d0.3232.0002	VLAN2	Gi0/11
Administrator	00d0.3232.1000	VLAN2	Gi0/12

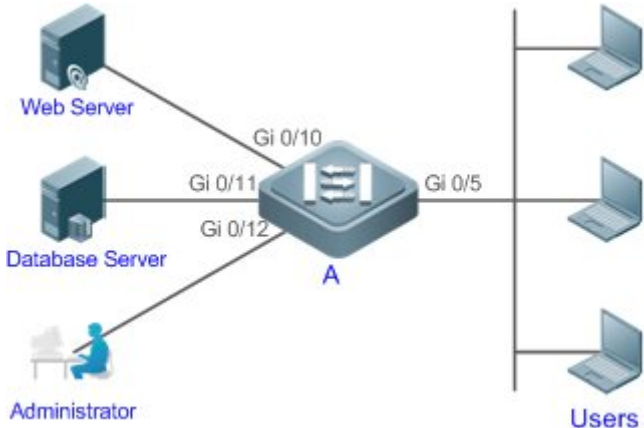
<p>Scenario Figure 2-7</p>	
<p>Configuration Steps</p>	<ul style="list-style-type: none"> ➤ Specify destination MAC addresses (<i>mac-address</i>). ➤ Specify the VLAN (<i>vlan-id</i>) where the MAC addresses reside. ➤ Specify interface IDs (<i>interface-id</i>).
<p>A</p>	<pre>A# configure terminal A(config)# mac address table static 08c6.b300.3232.0001 vlan 2 interface gigabitEthernet 0/10 A(config)# mac address table static 08c6.b300.3232.0002 vlan 2 interface gigabitEthernet 0/11 A(config)# mac address table static 08c6.b300.3232.1000 vlan 2 interface gigabitEthernet 0/12</pre>
<p>Verification</p>	<p>Display the static MAC address configuration on a switch.</p>
<p>A</p>	<pre>A# show mac address table static Vlan MAC Address Type Interface ----- 2 08c6.b300.3232.0001 STATIC GigabitEthernet 0/10 2 08c6.b300.3232.0002 STATIC GigabitEthernet 0/11 2 08c6.b300.3232.1000 STATIC GigabitEthernet 0/12</pre>

Common Errors

- Configure a static MAC address before configuring the specific port as a layer-2 interface, for example, a switch port or an AP port.

2. 4. 3 Configuring a MAC Address for Packet Filtering

Configurati on Effect

- If a device receives packets containing a source MAC address or destination MAC address specified as the filtered MAC address, the packets are discarded.

Configurati on Steps

❖ Configuring a MAC Address for Packet Filtering

- Optional.
- Perform this configuration to filter packets.
- Configuration:

Command	mac-address-table filtering <i>mac-address</i> vlan <i>vlan-id</i>
Parameter	address <i>mac-address</i> : Specifies a MAC address.
Description	vlan <i>vlan-id</i> : Specifies a VLAN where the MAC address resides.
Defaults	By default, no filtered MAC address is configured.
Command Mode	Global configuration mode
Usage Guide	If a device receives packets containing a source MAC address or destination MAC address specified as the filtered MAC address, the packets are discarded.

Verification

- Run the **show mac-address-table filter** command to display the filtered MAC address.

Command	show mac-address-table filter [address <i>mac-address</i>] [vlan <i>vlan-id</i>]
Parameter	address <i>mac-address</i> : Specifies a MAC address.
Description	vlan <i>vlan-id</i> : Specifies a VLAN where the MAC address resides.
Command Mode	Privileged EXEC mode/Global configuration mode /Interface configuration mode
Usage Guide	N/A
	<pre>Qtech# show mac address table filtering Vlan MAC Address Type Interface ----- 1 0000.2222.2222 FILTER</pre>

Configurati on Example

❖ Configuring a MAC Address for Packet Filtering

Configuration Steps	<ul style="list-style-type: none"> ➤ Specify a destination MAC address (<i>mac-address</i>) for filtering. ➤ Specify a VLAN where the MAC addresses resides.
	<pre>Qtech# configure terminal Qtech(config)# mac address table static 08c6.b300.3232.0001 vlan 1</pre>
Verification	Display the filtered MAC address configuration.
	<pre>Qtech# show mac address table filter Vlan MAC Address Type Interface ----- 1 08c6.b300.3232.0001 FILTER</pre>

2.4.4 Configuring MAC Address Change Notification

Configuration Effect

- Monitor change of devices connected to a network device.

Configuration Steps

❖ Configuring NMS

- Optional.
- Perform this configuration to enable an NMS to receive MAC address change notifications.
- Configuration:

Command	<code>snmp-server host <i>host-addr</i> traps [version { 1 2c 3 [auth noauth priv] }] <i>community-string</i></code>
Parameter Description	<p>host <i>host-addr</i>: Specifies the IP address of a receiver.</p> <ul style="list-style-type: none"> ● version { 1 2c 3 [auth noauth priv] }: Specifies the version of SNMP TRAP messages. You can also specify authentication and a security level for packets of Version 3. <p><i>community-string</i>: Indicates an authentication name.</p>
Defaults	By default, the function is disabled.
Command Mode	Global configuration mode
Usage Guide	N/A

❖ Enabling SNMP Trap

- Optional.
- Perform this configuration to send SNMP Trap messages.
- Configuration:

Command	snmp-server enable traps
Parameter Description	N/A
Defaults	By default, the function is disabled.
Command Mode	Global configuration mode
Usage Guide	N/A

❖ Configuring Global MAC Address Change Notification

- Optional.
- If MAC address change notification is disabled globally, it is disabled on all interfaces.
- Configuration:

Command	mac-address-table notification
Parameter Description	N/A
Defaults	By default, MAC address change notification is disabled globally.
Command Mode	Global configuration mode
Usage Guide	N/A

❖ Configuring MAC Address Change Notification On Interface

- Optional.
- Perform this configuration to enable MAC address change notification on an interface.
- Configuration:

Command	snmp trap mac-notification { added removed }
Parameter Description	added: Generates a notification when an MAC address is added. removed: Generates a notification when an MAC address is deleted.
Defaults	By default, MAC address change notification is disabled on an interface.
Command Mode	Interface configuration mode
Usage Guide	N/A

❖ Configuring Interval for Generating MAC Address Change Notifications and Volume of Notification History

- Optional.
- Perform this configuration to modify the interval for generating MAC address change notifications and the volume of notification history.
- Configuration:

Command	mac-address-table notification { interval <i>value</i> history-size <i>value</i> }
Parameter Description	interval <i>value</i>: (Optional) Indicates the interval for generating MAC address change notifications. The value ranges from 1 to 3600 seconds. history-size <i>value</i>: Indicates the maximum number of entries in the table of notification history. The value ranges from 1 to 200.
Defaults	The default interval is 1 second. The default maximum amount of notifications is 50.
Command Mode	Global configuration mode
Usage Guide	N/A

Verification

- Run the **show mac-address-table notification** command to check whether the NMS receives MAC address change notifications.

Command	show mac-address-table notification [interface [<i>interface-id</i>] history]								
Parameter Description	Interface: Displays the configuration of MAC address change notification on all interfaces. interface-id: Displays the configuration of MAC address change notification on a specified interface. history: Displays the history of MAC address change notifications.								
Command Mode	Privileged EXEC mode/Global configuration mode /Interface configuration mode								
Usage Guide	N/A								
Usage Guide	<p>Display the configuration of global MAC address change notification.</p> <pre>Qtech#show mac address table notification MAC Notification Feature : Enabled Interval (Sec) : 300 Maximum History Size : 50 Current History Size : 0</pre> <table border="1"> <thead> <tr> <th>Field</th> <th>Description</th> </tr> </thead> <tbody> <tr> <td>Interval(Sec)</td> <td>Indicates the interval for generating MAC address change notifications.</td> </tr> <tr> <td>Maximum History Size</td> <td>Indicates the maximum number of entries in the table of notification history.</td> </tr> <tr> <td>Current History Size</td> <td>Indicates the current notification entry number.</td> </tr> </tbody> </table>	Field	Description	Interval(Sec)	Indicates the interval for generating MAC address change notifications.	Maximum History Size	Indicates the maximum number of entries in the table of notification history.	Current History Size	Indicates the current notification entry number.
Field	Description								
Interval(Sec)	Indicates the interval for generating MAC address change notifications.								
Maximum History Size	Indicates the maximum number of entries in the table of notification history.								
Current History Size	Indicates the current notification entry number.								

Configurati on Example

Scenario
Figure 2-8

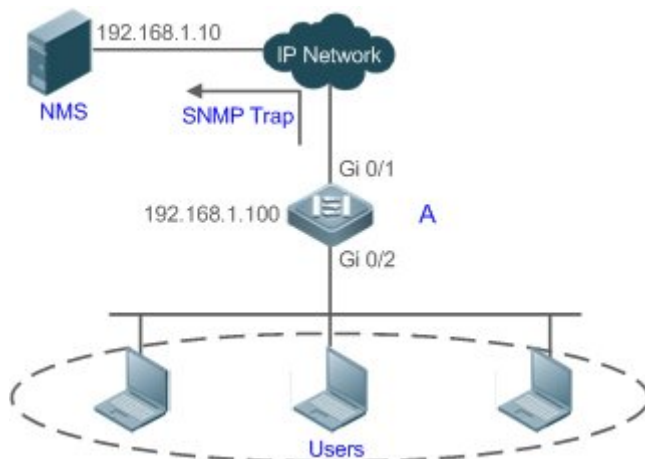

The figure shows an intranet of an enterprise. Users are connected to A via port Gi0/2.

The Perform the configuration to achieve the following effects:

- When port Gi0/2 learns a new MAC address or finishes aging a learned MAC address, a MAC address change notification is generated.
- Meanwhile, A sends the MAC address change notification in an SNMP Trap message to a specified NMS.
- In a scenario where A is connected to a number of Users, the configuration can prevent MAC address change notification burst in a short time so as to reduce the network flow.

Configuration Steps

- Enable global MAC address change notification on A, and configure MAC address change notification on port Gi0/2.
- Configure the IP address of the NMS host, and enable A with SNMP Trap. A communicates with the NMS via routing.
- Configure the interval for sending MAC address change notifications to 300 seconds (1 second by default).

A

```
Qtech# configure terminal
Qtech(config)# mac address table notification
Qtech(config)# interface gigabitEthernet 0/2
Qtech(config if GigabitEthernet 0/2)# snmp trap mac notification added
Qtech(config if GigabitEthernet 0/2)# snmp trap mac notification removed
Qtech(config if GigabitEthernet 0/2)# exit
Qtech(config)# snmp server host 192.168.1.10 traps version 2c comefrom2
Qtech(config)# snmp server enable traps
```

	<pre>Qtech(config)# mac address table notification interval 300</pre>
Verification	<ul style="list-style-type: none"> ➤ Check t whether MAC address change notification is enabled globally . ➤ Check whether MAC address change notification is enabled on the interface. ➤ Display the MAC addresses of interfaces, and run the clear mac-address-table dynamic command to simulate aging dynamic MAC addresses. ➤ Check whether global MAC address change notification is enabled globally. ➤ Display the history of MAC address change notifications.
A	<pre>Qtech# show mac address table notification MAC Notification Feature : Enabled Interval(Sec): 300 Maximum History Size : 50 Current History Size : 0 Qtech# show mac address table notification interface GigabitEthernet 0/2 Interface MAC Added Trap MAC Removed Trap GigabitEthernet 0/2 Enabled Enabled Qtech# show mac address table interface GigabitEthernet 0/2 Vlan MAC Address Type Interface 1 00d0.3232.0001 DYNAMIC GigabitEthernet 0/2 Qtech# show mac address table notification MAC Notification Feature : Enabled Interval(Sec): 300 Maximum History Size : 50 Current History Size : 1 Qtech# show mac address table notification history History Index : 0 Entry Timestamp: 221683 MAC Changed Message : Operation:DEL Vlan:1 MAC Addr: 00d0.3232.0003 GigabitEthernet 0/2</pre>

2. 4. 5 Configuring a Management VLAN for an AP Port

Configurati on Effect

- Enable an AP port to process the packets from a management VLAN as management packets, and those from a non-management VLAN as data packets.

Configurati on Steps

- ❖ Configuring a Management VLAN for an AP Port
- Optional.
- Perform this configuration to enable an AP port to distinguish management packets from data packets.
- Configuration:

Command	<code>aggregateport-admin vlan <i>vlan-list</i></code>
Parameter Description	<i>vlan-list</i> : Indicates a VLAN or a range of VLANs separated by "-".
Defaults	By default, no management VLAN is configured for an AP port.
Command Mode	Global configuration mode
Usage Guide	An AP port processes the packets received on the management VLAN as management packets.

Verification

- An AP port processes the packets from a management VLAN as management packets, and those from a non-management VLAN as data packets.

Configurati on Example

- ❖ Configuring a Management VLAN for an AP Port

Configuration Steps	➤ Specify management VLANs for an AP port.
	<pre>Qtech# configure terminal Qtech(config)# aggregateport admin vlan 1 20</pre>
Verification	Run the show running command to display the configuration.

2.5 Monitoring

Clearing

Running the clear commands may lose vital information and interrupt services.

Description	Command
Clears dynamic MAC addresses.	clear mac-address-table dynamic [address <i>mac-address</i>] [interface <i>interface-id</i>] [vlan <i>vlan-id</i>]

Displaying

Description	Command
Displays the MAC address table.	show mac-address-table { dynamic static filter } [address <i>mac-address</i>] [interface <i>interface-id</i>] [vlan <i>vlan-id</i>]
Displays the aging time for dynamic MAC addresses.	show mac-address-table aging-time
Displays the maximum number of dynamic MAC addresses.	show mac-address-table max-dynamic-mac-count
Displays the configuration and history of MAC address change notifications.	show mac-address-table notification [interface [<i>interface-id</i>]] history]

Debugging

System resources are occupied when debugging information is output. Therefore, disable debugging immediately after use.

Description	Command
Debugs MAC address operation.	debug bridge mac

3. CONFIGURING AGGREGATE PORT

3.1 Overview

An aggregate port (AP) is used to bundle multiple physical links into one logical link to increase the link bandwidth and improve connection reliability.

An AP port supports load balancing, namely, distributes load evenly among member links. Besides, an AP port realizes link backup. When a member link of the AP port is disconnected, the load carried by the link is automatically allocated to other functional member links. A member link does not forward broadcast or multicast packets to other member links.

For example, the link between two devices supports a maximum bandwidth of 1,000 Mbps. When the service traffic carried by the link exceeds 1,000 Mbps, the traffic in excess will be discarded. Port aggregation can be used to solve the problem. For example, you can connect the two devices with network cables and combine multiple links to form a logical link capable of multiples of 1,000 Mbps.

For example, there are two devices connected by a network cable. When the link between the two ports of the devices is disconnected, the services carried by the link will be interrupted. After the connected ports are aggregated, the services will not be affected as long as one link remains connected.

Protocols and Standards

- IEEE 802.3ad

3.2 Applications

Applications	Description
AP Link Aggregation and Load Balancing	A large number of packets are transmitted between an aggregation device and a core device, which requires a greater bandwidth. To meet this requirement, you can bundle the physical links between the devices into one logical link to increase the link bandwidth, and configure a proper load balancing algorithm to distribute the work load evenly to each physical link, thus improving bandwidth utilization.

3.2.1 AP Link Aggregation and Load Balancing

Scenario

In Figure 31, the switch communicates with the router through an AP port. All the devices on the intranet (such as the two PCs on the left) use the router as a gateway. All the devices on the extranet (such as the two PCs on the right) send packets to the internet devices through the router, with the gateway's MAC address as its source MAC address. To distribute the load between the router and other hosts to other links, configure destination MAC address-based load balancing. On the switch, configure source MAC address-based load balancing.

Figure 3-1 AP Link Aggregation and Load Balancing

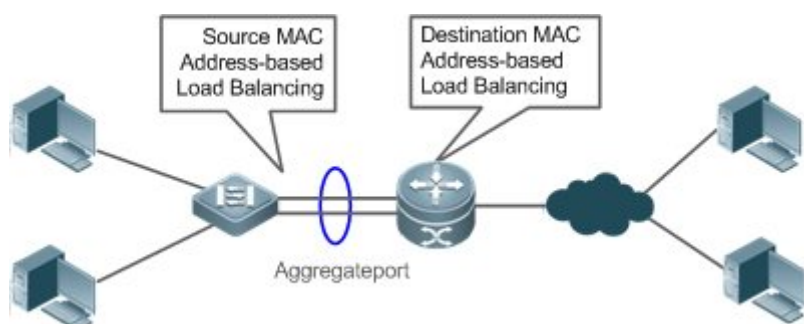

Deployment

- Configure the directly connected ports between the switch and router as a static AP port or a Link Aggregation Control Protocol (LACP) AP port.
- On the switch, configure a source MAC address-based load balancing algorithm.
- On the router, configure a destination MAC address-based load balancing algorithm.

3.3 Features

Basic Concepts

❖ Static AP

The static AP mode is an aggregation mode in which physical ports are directly added to an AP aggregation group through manual configuration to allow the physical ports to forward packets when the ports are proper in link state and protocol state.

An AP port in static AP mode is called a static AP, and its member ports are called static AP member ports.

❖ LACP

LACP is a protocol about dynamic link aggregation. It exchanges information with the connected device through LACP data units (LACPDUs).

An AP port in LACP mode is called an LACP AP port, and its member ports are called LACP AP member ports.

❖ AP Member Port Mode

There are three aggregation modes available, namely, active, passive, and static.

AP member ports in active mode initiate LACP negotiation. AP member ports in passive mode only respond to received LACPDUs. AP member ports in static mode do not send LACPDUs for negotiation. The following table lists the requirements for peer port mode.

Port Mode	Peer Port Mode
Active mode	Active or passive mode
Passive mode	Active mode
Static Mode	Static Mode

❖ AP Member Port State

There are two kinds of AP member port state available:

- When a member port is Down, the port cannot forward packets. The Down state is displayed.
- When a member port is Up and the link protocol is ready, the port can forward packets. The Up state is displayed.

There are three kinds of LACP member port state:

- When the link of a port is Down, the port cannot forward packets. The Down state is displayed.
- When the link of a port is Up and the port is added to an aggregation group, the bndl state is displayed.
- When the link of a port is Up but the port is suspended because the peer end is not enabled with LACP or the attributes of the ports are inconsistent with those of the master port, the susp state is displayed. (The port in susp state does not forward packets.)

-
- Only full-duplex ports are capable of LACP aggregation.
 - LACP aggregation can be implemented only when the rates, flow control approaches, medium types, and Layer-2/3 attributes of member ports are consistent.
 - If you modify the preceding attributes of a member port in the aggregation group, LACP aggregation will fail.
-

The ports which are prohibited from joining or exiting an AP port cannot be added to or removed from a static AP port or an LACP AP port.

❖ AP Capacity Mode

The maximum number of member ports is fixed, which is equal to the maximum number of AP ports multiplied by the maximum number of member ports supported by a single AP port. If you want to increase the maximum number of AP ports, the maximum number of member ports supported by a single AP port must be reduced, and vice versa. This concerns the AP capacity mode concept. Some devices support the configuration of the AP capacity mode. For example, if the system supports 16,384 member ports, you can select the 1024 x 16, 512 x 32, and other AP capacity modes (Maximum number of AP ports multiplied by the maximum number of member ports supported by a single AP port).

❖ LACP System ID

One device can be configured with only one LACP aggregation system. The system is identified by a system ID and each system has a priority, which is a configurable value. The system ID consists of the LACP system priority and MAC address of the device. A lower system priority indicates a higher priority of the system ID. If the system priorities are the same, a smaller MAC address of the device indicates a higher priority of the system ID. The system with an ID of a higher priority determines the port state. The port state of a system with an ID of a lower priority keeps consistent with that of a higher priority.

❖ LACP Port ID

Each port has an independent LACP port priority, which is a configurable value. The port ID consists of the LACP port priority and port number. A smaller port priority indicates a higher priority of the port ID. If the port priorities are the same, a smaller port number indicates a higher priority of the port ID.

❖ LACP Master Port

When dynamic member ports are Up, LACP selects one of those ports to be the master port based on the rates and duplex modes, ID priorities of the ports in the aggregation group, and the bundling state of the member ports in Up state. Only the ports that have the same attributes as the master port are in Bundle state and participate in data forwarding. When the attributes of ports are changed, LACP reselects a master port. When the new master port is not in Bundle state, LACP disaggregates the member ports and performs aggregation again.

❖ Preferred AP Member Port

The preferred AP member port feature is used when an AP port is connected to a server with two systems. An AP member port is selected as the preferred port which will forward specified packets (packets of the management VLAN) to the server. These packets will not

be distributed to other member ports by load balancing. This ensures the communication with the server.

Configure the port connected to the management network interface card (NIC) of the server as the preferred AP member port.

Some Linux servers have two systems. For example, an HP server has a master system and remote management system. The master system is a Linux system. The remote management system with Integrated Lights-Out (iLO) provides remote management at the hardware-level. iLO can manage the server remotely even when the master system is restarted. The master system has two NICs bundled into an AP port for service processing. The management system uses one of the two NICs for remote management. Because services are separated by different VLANs, the VLAN used by the management system is called a management VLAN. The port of a device connected to a server with two NICs is an AP port. The packets of the management VLAN must be sent by the member port connected to the NICs of the server to ensure the communication with the remote management system. You can configure a preferred AP member port to send the packets of the management VLAN.

For a server with two NICs bundled through LACP, if LACP is not running when the master system is restarted, LACP negotiation fails and the AP port is Down. At that time, the preferred AP member port is downgraded into a static member port and it is bound to the AP port for communication with the remote management system of the server. The preferred AP member port will be enabled with LACP again for negotiation after the Linux system is restarted and LACP runs normally.

❖ Minimum Number of AP Member Ports

An LACP aggregation system can be configured with a minimum number of AP member ports. When a member port exits the LACP aggregation group, causing the number of member ports to be smaller than the minimum number, the other member ports in the group are unbundled. When the member port rejoins the group, causing the number of member ports to be greater than the minimum number, the member ports in the group are automatically bundled.

Overview

Overview	Description
Link Aggregation	Aggregates physical links statically or dynamically to realize bandwidth extension and link backup.
Load Balancing	Balances the load within an aggregation group flexibly by using different load balancing methods.

3.3.1 Link Aggregation

Working Principle

There are two kinds of AP link aggregation. One is static AP, and the other is dynamic aggregation through LACP.

- Static AP

The static AP configuration is simple. Run a command to add the specified physical port to the AP port. After joining the aggregation group, a member port can receive and transmit data and participate in load balancing within the group.

- Dynamic AP (LACP)

An LACP-enabled port sends LACPDU to advertise its system priority, system MAC address, port priority, port number, and operation key. When receiving the LACPDU from the peer end, the device compares the system priorities of both ends based on the system ID in the packet. The end with a higher system ID priority sets the ports in the aggregation group to Bundle state based on the port ID priorities in a descending order, and sends an updated LACPDU. When receiving the LACPDU, the peer end sets corresponding ports to Bundle state so that both ends maintain consistency when a port exits or joins the aggregation group. The physical link can forward packets only after the ports at both ends are bundled dynamically.

After link aggregation, the LACP member ports periodically exchange LACPDUs. When a port does not receive an LACPDU in the specified time, a timeout occurs and the links are unbundled. In this case, the member ports cannot forward packets. There are two timeout modes: long timeout and short timeout. In long timeout mode, a port sends a packet every 30s. If it does not receive a packet from the peer end in 90s, a timeout occurs. In short timeout mode, a port sends a packet every 1s. If it does not receive a packet from the peer end in 3s, a timeout occurs.

3.3.2 Load Balancing

Working Principle

AP ports segregate packet flows by using load balancing algorithms based on packet features, such as the source and destination MAC addresses, source and destination IP addresses, and Layer-4 source and destination port numbers. The packet flow with the consistent feature is transmitted by one member link, and different packet flows are evenly distributed to member links. For example, in source MAC address-based load balancing, packets are distributed to the member links based on the source MAC addresses of the

packets. Packets with different source MAC addresses are evenly distributed to member links. Packets with the identical source MAC address are forwarded by one member link.

Currently, there are several AP load balancing modes as follows:

- Source MAC address or destination MAC address
 - Source MAC address + destination MAC address
 - Source IP address or destination IP address
 - Source IP address + destination IP address
 - Layer-4 source port number or Layer-4 destination port number
 - Layer-4 source port number + Layer-4 destination port number
 - Source IP address + Layer-4 source port number
 - Source IP address + Layer-4 destination port number
 - Destination IP address + Layer-4 source port number
 - Destination IP address + Layer-4 destination port number
 - Source IP address + Layer-4 source port number + Layer-4 destination port number
 - Destination IP address + Layer-4 source port number + Layer-4 destination port number
 - Source IP address + destination IP address + Layer-4 source port number
 - Source IP address + destination IP address + Layer-4 destination port number
 - Source IP address + destination IP address + Layer-4 source port number + Layer-4 destination port number
 - Panel port for incoming packets
 - Labels of Multiprotocol Label Switching (MPLS) packets
 - Aggregation member port polling
 - Enhanced mode
-
- Load balancing based on IP addresses or port numbers is applicable only to Layer-3 packets. When a device enabled with this load balancing method receives Layer-2 packets, it automatically switches to the default load balancing method.
 - All the load balancing methods use a load algorithm (hash algorithm) to calculate the member links based on the input parameters of the methods. The input parameters include the source MAC address, destination MAC address, source MAC address + destination MAC address, source IP address, destination IP address, source IP address + destination IP addresses, source

IP address + destination IP address + Layer-4 port number and so on. The algorithm ensures that packets with different input parameters are evenly distributed to member links. It does not indicate that these packets are always distributed to different member links. For example, in IP address-based load balancing, two packets with different source and destination IP addresses may be distributed to the same member link through calculation.

➤ Different products may support different load balancing algorithms.

❖ Enhanced Load Balancing

Enhanced load balancing allows the combination of multiple fields in different types of packets. These fields include **src-mac**, **dst-mac**, **I2-protocol**, **vlan**, **src-port**, and **dst-port** in Layer-2 packets, **src-ip**, **dst-ip**, **protocol**, **I4-src-port**, **I4-dst-port**, **vlan**, **src-port**, **dst-port**, **I2-etype**, **src-mac**, and **dst-mac** in IPv4 packets, **src-ip**, **dst-ip**, **protocol**, **I4-src-port**, **I4-dst-port**, **vlan**, **src-port**, **dst-port**, **I2-etype**, **src-mac**, and **dst-mac** in IPv6 packets; **top-label**, **2nd-label**, **3rd-label**, **src-ip**, **dst-ip**, **vlan**, **src-port**, **dst-port**, **src-mac**, **dst-mac**, **protocol**, **I4-src-port**, **I4-dst-port**, and **I2-etype** in MPLS packets; **vlan**, **src-port**, **src-mac**, **src-ip**, **protocol**, **I4-src-port**, **I4-dst-port**, **I2-etype**, **ing-nick**, **egr-nick**, **dst-port**, **dst-mac**, and **dst-ip** in TRILL packets and **vlan**, **src-port**, **src-id**, **rx-id**, **ox-id**, **fabric-id**, **dst-port**, and **dst-id** in FCoE packets.

A device enabled with enhanced load balancing first determines the type of packets to be transmitted and performs load balancing based on the specified fields in the packets. For example, the AP port performs source IP-based load balancing on the packets containing an ever-changing source IPv4 address.

- All the load balancing methods are applicable to Layer-2 and Layer-3 AP ports. You need to configure proper load distribution methods based on different network environments to fully utilize network bandwidth.
- Perform enhanced load balancing based on the **src-mac**, **dst-mac**, and **vlan** fields in Layer-2 packets, and the **src-ip** field in IPv4 packets. If the incoming packet is an IPv4 packet with an ever-changing source MAC address, the enhanced balancing algorithm does not take effect, because the device will perform load balancing only based on the **src-ip** field in the IPv4 packet after finding that it is an IPv4 packet.
- In enhanced load balancing, the MPLS balancing algorithm takes effect only for MPLS Layer-3 VPN packets, but does not take effect for MPLS Layer-2 VPN packets.

3.4 Configuration

Configuration	Description and Command	
Configuring Static AP Ports	(Mandatory) It is used to configure link aggregation manually.	
	interface aggregateport	Creates an Ethernet AP port.
	interface san-port-channel	Creates an FC AP port.

Configuration	Description and Command	
	port-group	Configures static AP member ports.
Configuring LACP AP Ports	(Mandatory) It is used to configure link aggregation dynamically.	
	port-group mode	Configures LACP member ports.
	lACP port-priority	Configures the port priority.
	lACP short-timeout	Configures the short timeout mode on a port.
Enabling LinkTrap	(Optional) It is used to enable LinkTrap.	
	snmp trap link-status	Enables LinkTrap advertisement for an AP port.
	aggregateport member linktrap	Enables LinkTrap t for AP member ports.
Configuring a Load Balancing Mode	(Optional) It is used to configure a load balancing mode for an aggregated link.	
	aggregateport load-balance	Configures a load balancing algorithm for an AP port or AP member ports.
	(Optional) It is used to configure the profile of enhanced load balancing.	
	load-balance-profile	Creates the profile of enhanced load balancing.
	I2 field	Configures a load balancing mode for Layer-2 packets.
	ipv4 field	Configures a load balancing mode for IPv4 packets.
	ipv6 field	Configures a load balancing mode for IPv6 packets.
	mpls field	Configures a load balancing mode for MPLS packets.
	trill field	Configures a load balancing mode for TRILL packets.
	fcoe field	Configures a load balancing mode for FCoE packets.
Configuring an AP Capacity Mode	(Optional) It is used to configure the AP capacity mode.	
	aggregateport capacity mode	Configures an AP capacity mode in global configuration mode.
Configuring a Preferred AP Member Port	(Optional) It is used to configure an AP member port as the preferred port.	
	aggregateport primary-port	Configures an AP member port as the preferred port.

Configuration	Description and Command
Configuring the Minimum Number of LACP AP Member Ports	Aggregateport minimum member Configures the minimum number of LACP AP member ports.

3.4.1 Configuring Static AP Ports

Configurati on Effect

- Configure multiple physical ports as AP member ports to realize link aggregation.
- The bandwidth of the aggregation link is equal to the sum of the member link bandwidths.
- When a member link of the AP port is disconnected, the load carried by the link is automatically allocated to other functional member links.

Notes

- Only physical ports can be added to an AP port.
- The ports of different media types or port modes cannot be added to the same AP port.
- Layer-2 ports can be added to only a Layer-2 AP port, and Layer-3 ports can be added to only a Layer-3 AP port. The Layer-2/3 attributes of an AP port that contains member ports cannot be modified.
- After a port is added to an AP port, the attributes of the port are replaced by those of the AP port.
- After a port is removed from an AP port, the attributes of the port are restored.

! After a port is added to an AP port, the attributes of the port are consistent with those of the AP port. Therefore, do not perform configuration on the AP member ports or apply configuration to a specific AP member port. However, some configurations (the **shutdown** and **no shutdown** commands) can be configured on AP member ports. When you use AP member ports, check whether the function that you want to configure can take effect on a specific AP member port, and perform this configuration properly.

Configurati on Steps

- ❖ Creating an Ethernet AP Port
 - Mandatory.
 - Perform this configuration on an AP-enabled device.

Command	<code>interface aggregateport ap-number</code>
---------	--

Parameter Description	<i>ap-number</i> : Indicates the number of an AP port.
Defaults	By default, no AP port is created.
Command Mode	Global configuration mode
Usage Guide	To create an Ethernet AP port, run interfaces aggregateport in global configuration mode. To delete the specified Ethernet AP port, run no interfaces aggregateport ap-number in global configuration mode.

- Run **port-group** to add a physical port to a static AP port in interface configuration mode. If the AP port does not exist, it will be created automatically.
- Run **port-group mode** to add a physical port to an LACP AP port in interface configuration mode. If the AP port does not exist, it will be created automatically.
- The AP feature must be configured on the devices at both ends of a link and the AP mode must be the same (static AP or LACP AP).

❖ Configuring Static AP Member Ports

- Mandatory.
- Perform this configuration on AP-enabled devices.

Command	port-group <i>ap-number</i>
Parameter Description	port-group <i>ap-number</i> : Indicates the number of an AP port.
Defaults	By default, no ports are added to any static AP port.
Command Mode	Interface configuration mode of the specified Ethernet port
Usage Guide	To add member ports to an AP port, run port-group in interface configuration mode. To remove member ports from an AP port, run no port-group in interface configuration mode.

- The static AP member ports configured on the devices at both ends of a link must be consistent.
- After a member port exits the AP port, the default settings of the member port are restored. Different functions deal with the default settings of the member ports differently. It is recommended that you check and confirm the port settings after a member port exits an AP port.
- After a member port exits an AP port, the port is disabled by using the **shutdown** command to avoid loops. After you confirm that the topology is normal, run **no shutdown** in interface configuration mode to enable the port again.

❖ Converting Layer-2 APs to Layer-3 APs

- Optional.
- When you need to enable Layer-3 routing on an AP port, for example, to configure IP addresses or static route entries, convert the Layer-2 AP port to a Layer-3 AP port and enable routing on the Layer-3 AP port.
- Perform this configuration on AP-enabled devices that support Layer-2 and Layer-3 features, such as Layer-3 switches or wireless access controllers (ACs).

Command	no switchport
Parameter	N/A
Description	
Defaults	By default, the AP ports are Layer-2 AP ports.
Command Mode	Interface configuration mode of the specified AP port
Usage Guide	The Layer-3 AP feature is supported by only Layer-3 devices.

- The AP port created on a Layer-3 device that does not support Layer-2 feature is a Layer-3 AP port. Otherwise, the AP port is a Layer-2 AP port.

❖ Creating an Ethernet AP Subinterface

- Optional.
- On a device that supports subinterface configuration, run **interface aggregateport sub-ap-number** to create a subinterface.
- Perform this configuration on AP-enabled devices that support Layer-2 and Layer-3 features, such as Layer-3 switches.

Command	interface aggregateport sub-ap-number
Parameter	<i>sub-ap-number</i> : Indicates the number of an AP subinterface.
Description	
Defaults	By default, no subinterfaces are created.
Command Mode	Interface configuration mode of the specified AP port
Usage Guide	You need to convert the master port of the AP port to a Layer-3 port before creating a subinterface.

Verification

- Run **show running** to display the configuration.
- Run **show aggregateport summary** to display the AP configuration.

Command	show aggregateport aggregate-port-number [load-balance summary]
Parameter	<i>aggregate-port-number</i> : Indicates the number of an AP port.
Description	load-balance : Displays the load balancing algorithm.

	summary: Displays the summary of each link.
Command Mode	Any mode
Usage Guide	The information on all AP ports is displayed if you do not specify the AP port number.
	<pre>Qtech# show aggregateport 1 summary AggregatePort MaxPorts SwitchPort Mode Load balance Ports Ag1 8 Enabled ACCESS dst-mac Gi0/2</pre>

Configurati on Example

❖ Configuring an Ethernet Static AP Port

Scenario Figure 3-2	
Configuratio n Steps	<ul style="list-style-type: none"> ➤ Add the GigabitEthernet 1/1 and GigabitEthernet 1/2 ports on Switch A to static AP port 3. ➤ Add the GigabitEthernet 2/1 and GigabitEthernet 2/2 ports on Switch B to static AP port 3.
Switch A	<pre>SwitchA# configure terminal SwitchA(config)# interface range GigabitEthernet 1/1 2 SwitchA(config if range)# port group 3</pre>
Switch B	<pre>SwitchB# configure terminal SwitchB(config)# interface range GigabitEthernet 2/1 2 SwitchB(config if range)# port group 3</pre>
Verification	<ul style="list-style-type: none"> ➤ Run show aggregateport summary to check whether AP port 3 contains member ports GigabitEthernet 1/1 and GigabitEthernet 1/2.
Switch A	<pre>SwitchA# show aggregateport summary AggregatePort MaxPorts SwitchPort Mode Ports</pre>

	<pre> Ag3 8 Enabled ACCESS Gi1/1,Gi1/2 </pre>
Switch B	<pre> SwitchB# show aggregateport summary AggregatePort MaxPorts SwitchPort Mode Ports Ag3 8 Enabled ACCESS Gi2/1,Gi2/2 </pre>

3.4.2 Configuring LACP AP Ports

Configurati on Effect

- Connected devices perform autonegotiation through LACP to realize dynamic link aggregation.
- The bandwidth of the aggregation link is equal to the sum of the member link bandwidths.
- When a member link of the AP port is disconnected, the load carried by the link is automatically allocated to other functional member links.
- It takes LACP 90s to detect a link failure in long timeout mode and 3s in short timeout mode.

Notes

- After a port exits an LACP AP port, the default settings of the port may be restored. Different functions deal with the default settings of the member ports differently. It is recommended that you check and confirm the port settings after a member port exits an LACP AP port.
- Changing the priority of an LACP member port may cause the other member ports to be disaggregated and aggregated again.

Configurati on Steps

- ❖ Configuring LACP Member Ports
 - Mandatory.
 - Perform this configuration on LACP-enabled devices.

Command	<code>port-group key-number mode { active passive }</code>
Parameter Description	<p><i>Key-number</i>: Indicates the management key of an AP port. In other words, it is the LACP AP port number. The maximum value is subject to the number of AP ports supported by the device.</p> <p>active: Indicates that ports are added to a dynamic AP port actively.</p>

	passive: Indicates that ports are added to a dynamic AP port passively.
Defaults	By default, no physical ports are added to any LACP AP port.
Command Mode	Interface configuration mode of the specified physical port
Usage Guide	Use this command in interface configuration mode to add member ports to an LACP AP port.

➤ The LACP member port configuration at both ends of a link must be consistent.

❖ Configuring the Timeout Mode of LACP Member Ports

- Optional.
- When you need to implement real-time link failure detection, configure the short timeout mode. It takes LACP 90s to detect a link failure in long timeout mode and 3s in short timeout mode.
- Perform this configuration on LACP-enabled devices, such as switches.

Command	lACP short-timeout
Parameter Description	N/A
Defaults	By default, the timeout mode of LACP member ports is long timeout.
Command Mode	Interface configuration mode
Usage Guide	The timeout mode is supported only by physical ports. To restore the default settings, run no lACP short-timeout in interface configuration mode.

Verification

- Run **show running** to display the configuration.
- Run **show lACP summary** to display LACP link state.

Command	show lACP summary [key-number]
Parameter Description	<i>key-name</i> : Indicates the number of an LACP AP port.
Command Mode	Any mode
Usage Guide	The information on all LACP AP ports is displayed if you do not specify <i>key-name</i> .
	<pre>Qtech(config)# show lACP summary 3 System Id:32768, 08c6.b3fb.0002</pre>

```

Flags: S   Device is requesting Slow LACPDUs
F   Device is requesting Fast LACPDUs.
A   Device is in active mode.           P   Device is in passive mode.

Aggregate port 3:
Local information:
LACP port      Oper  Port      Port
Port  Flags   State   Priority   Key   Number  State

Gi0/1   SA     bndl    4096      0x3   0x1     0x3d
Gi0/2   SA     bndl    4096      0x3   0x2     0x3d
Gi0/3   SA     bndl    4096      0x3   0x3     0x3d

Partner information:
                LACP port      Oper  Port      Port
Port  Flags   Priority   Dev ID   Key   Number  State

Gi0/1   SA     61440    08c6.b300.0001  0x3   0x1     0x3d
Gi0/2   SA     61440    08c6.b300.0001  0x3   0x2     0x3d
Gi0/3   SA     61440    08c6.b300.0001  0x3   0x3     0x3d
    
```

Configurati on Example



<p>S</p> <p>3-3</p>	<p>GigabitEthernet1/1 GigabitEthernet2/1</p> <p>GigabitEthernet1/2 GigabitEthernet2/2</p> <p>MAC: 08c6.b300.0001 MAC: 08c6.b300.0002</p> <p>System priority:4096 System priority:61440</p> <p>Switch A Switch B</p>
<p>Configuratio n Steps</p>	<ul style="list-style-type: none"> ➤ On Switch A, set the LACP system priority to 4096. ➤ Enable dynamic link aggregation on the GigabitEthernet1/1 and GigabitEthernet1/2 ports on Switch A and add the ports to LACP AP port 3. ➤ On Switch B, set the LACP system priority to 61440. ➤ Enable dynamic link aggregation on the GigabitEthernet2/1 and GigabitEthernet2/2 ports on Switch B and add the ports to LACP AP port 3.

Switch A	<pre>SwitchA# configure terminal SwitchA(config)# interface range GigabitEthernet 1/1 2 SwitchA(config if range)# port group 3 mode active SwitchA(config if range)# end</pre>
Switch B	<pre>SwitchB# configure terminal SwitchB(config)# interface range GigabitEthernet 2/1 2 SwitchB(config if range)# port group 3 mode active SwitchB(config if range)# end</pre>
Verification	<p>➤ Run show lacp summary 3 to check whether LACP AP port 3 contains member ports GigabitEthernet2/1 and GigabitEthernet2/2.</p>
Switch A	<pre>SwitchA# show LACP summary 3 System Id:32768, 08c6.b3fb.0001 Flags: S Device is requesting Slow LACPDUs F Device is requesting Fast LACPDUs. A Device is in active mode. P Device is in passive mode. Aggregate port 3: Local information: LACP port Oper Port Port Port Flags State Priority Key Number State ----- Gi1/1 SA bnd1 32768 0x3 0x1 0x3d Gi1/2 SA bnd1 32768 0x3 0x2 0x3d Partner information: LACP port Oper Port Port Port Flags Priority Dev ID Key Number State ----- Gi2/1 SA 32768 08c6.b300.0002 0x3 0x1 0x3d Gi2/2 SA 32768 08c6.b300.0002 0x3 0x2 0x3d</pre>
Switch B	<pre>SwitchB# show LACP summary 3 System Id:32768, 08c6.b3fb.0002</pre>

```

Flags: S   Device is requesting Slow LACPDUs
      F   Device is requesting Fast LACPDUs.
      A   Device is in active mode.          P   Device is in passive mode.

Aggregate port 3:
Local information:
LACP port      Oper   Port      Port
Port   Flags   State   Priority   Key   Number   State

Gi2/1   SA     bndl    32768     0x3   0x1     0x3d
Gi2/2   SA     bndl    32768     0x3   0x2     0x3d

Partner information:
                LACP port      Oper   Port   Port
Port   Flags   Priority   Dev ID   Key   Number   State

Gi1/1   SA     32768     08c6.b300.0001  0x3   0x1     0x3d
Gi1/2   SA     32768     08c6.b300.0001  0x3   0x2     0x3d
    
```

3.4.3 Enabling LinkTrap

Configurati on Effect

Enable the system with LinkTrap to send LinkTrap messages when aggregation links are changed.

Configurati on Steps

❖ Enabling LinkTrap for an AP Port

- Optional.
- Enable LinkTrap in interface configuration mode. By default, LinkTrap is enabled. LinkTrap messages are sent when the link state or protocol state of the AP port is changed.
- Perform this configuration on AP-enabled devices.

Command	snmp trap link-status
Parameter	N/A
Description	

Defaults	By default, LinkTrap is enabled.
Command Mode	Interface configuration mode of the specified AP port
Usage Guide	Use this command in interface configuration mode to enable LinkTrap for the specified AP port. After LinkTrap is enabled, LinkTrap messages are sent when the link state of the AP port is changed. Otherwise, LinkTrap messages are not sent. By default, LinkTrap is enabled. To disable LinkTrap for an AP port, run no snmp trap link-status in interface configuration mode. LinkTrap cannot be enabled for a specific AP member port. To enable LinkTrap for all AP member ports, run aggregateport member linktrap in global configuration mode.

❖ Enabling LinkTrap for AP Member Ports

- Optional.
- By default, LinkTrap is disabled for AP member ports.
- Perform this configuration on AP-enabled devices.

Command	aggregateport member linktrap
Parameter Description	N/A
Defaults	By default, LinkTrap is disabled for AP member ports.
Command Mode	Global configuration mode
Usage Guide	Use this command in global configuration mode to enable LinkTrap for all AP member ports. By default, LinkTrap messages are not sent when the link state of AP member ports is changed. To disable LinkTrap for all AP member ports, run no aggregateport member linktrap in global configuration mode.

Verification

- Run **show running** to display the configuration.
- After LinkTrap is enabled, you can monitor this feature on AP ports or their member ports by using the MIB software.

Configuration on Example

❖ Enabling LinkTrap for AP Member Ports

Scenario	
Figure 3-4	

<p>Configuration Steps</p>	<ul style="list-style-type: none"> ➤ Add the GigabitEthernet 1/1 and GigabitEthernet 1/2 ports on Switch A to static AP port 3. ➤ Add the GigabitEthernet 2/1 and GigabitEthernet 2/2 ports on Switch B to static AP port 3. ➤ On Switch A, disable LinkTrap for AP port 3 and enable LinkTrap for its member ports. ➤ On Switch B, disable LinkTrap for AP port 3 and enable LinkTrap its AP member ports.
<p>Switch A</p>	<pre>SwitchA# configure terminal SwitchA(config)# interface range GigabitEthernet 1/1 2 SwitchA(config if range)# port group 3 SwitchA(config if range)# exit SwitchA(config)# aggregateport member linktrap SwitchA(config)# interface Aggregateport 3 SwitchA(config if AggregatePort 3)# no snmp trap link status</pre>
<p>Switch B</p>	<pre>SwitchB# configure terminal SwitchB(config)# interface range GigabitEthernet 2/1 2 SwitchB(config if range)# port group 3 SwitchB(config if range)# exit SwitchB(config)# aggregateport member linktrap SwitchB(config)# interface Aggregateport 3 SwitchB(config if AggregatePort 3)# no snmp trap link status</pre>
<p>Verification</p>	<ul style="list-style-type: none"> ➤ Run show running to check whether LinkTrap is enabled for AP port 3 and its member ports.
<p>Switch A</p>	<pre>SwitchA# show run include AggregatePort 3 Building configuration... Current configuration: 54 bytes interface AggregatePort 3 no snmp trap link-status SwitchA# show run include AggregatePort aggregateport member linktrap</pre>
<p>Switch B</p>	<pre>SwitchB# show run include AggregatePort 3 Building configuration...</pre>

```
Current configuration: 54 bytes
interface AggregatePort 3
    no snmp trap link-status
SwitchB# show run | include AggregatePort
aggregateport member linktrap
```

3.4.4 Configuring a Load Balancing Mode

Configurati on Effect

The system distributes incoming packets among member links by using the specified load balancing algorithm. The packet flow with the consistent feature is transmitted by one member link, whereas different packet flows are evenly distributed to various links. A device enabled with enhanced load balancing first determines the type of packets to be transmitted and performs load balancing based on the specified fields in the packets. For example, the AP port performs source IP-based load balancing on the packets containing an ever-changing source IPv4 address.

Configurati on Steps

- ❖ Configuring the Global Load Balancing Algorithm of an AP port
 - (Optional) Perform this configuration when you need to optimize load balancing.
 - Perform this configuration on AP-enabled devices.

Command	<code>aggregateport load-balance { dst-mac src-mac src-dst-mac dst-ip src-ip src-dst-ip enhanced profile profile-name }</code>
Parameter Description	<p>dst-mac: Indicates that load is distributed based on the destination MAC addresses of incoming packets.</p> <p>src-mac: Indicates that load is distributed based on the source MAC addresses of incoming packets.</p> <p>src-dst-ip: Indicates that load is distributed based on source and destination IP addresses of incoming packets.</p> <p>dst-ip: Indicates that load is distributed based on the destination IP addresses of incoming packets.</p> <p>src-ip: Indicates that load is distributed based on the source IP addresses of incoming packets.</p> <p>src-dst-mac: Indicates that load is distributed based on source and destination MAC addresses of incoming packets.</p> <p>enhanced profile profile-name: Indicates the name of the enhanced load balancing profile.</p>
Defaults	Load balancing can be based on source and destination MAC addresses (applicable to switches) or source and destination IP addresses (applicable to gateways).

Command Mode	Global configuration mode
Usage Guide	<p>To restore the default settings, run no aggregateport load-balance in global configuration mode. You can run aggregateport load-balance in interface configuration mode of an AP port on devices that support load balancing configuration on a specific AP port. The configuration in interface configuration mode prevails. To disable the load balancing algorithm, run no aggregateport load-balance in interface configuration mode of the AP port. After that, the load balancing algorithm configured in global configuration mode takes effect.</p> <p>➤ You can run aggregateport load-balance in interface configuration mode of an AP port on devices that support load balancing configuration on a specific AP port.</p>

❖ Creating the Profile of Enhanced Load Balancing

- If the enhanced load balancing mode is selected, the enhanced load balancing profile must be configured. Otherwise, it will fail to set the AP load balancing to an enhanced one. In other cases, the configuration is optional.
- Perform this configuration on devices that support enhanced load balancing, such as aggregation switches and core switches.

Command	load-balance-profile <i>profile-name</i>
Parameter Description	<i>profile-name</i> : Indicates the profile name, which contains up to 31 characters.
Defaults	No enhanced load balancing profile exists.
Command Mode	Global configuration mode
Usage Guide	<p>To delete the default load balancing profile, run default load-balance-profile <i>profile-name</i> in global configuration mode.</p> <p>To create a profile name, run load-balance-profile <i>profile-name</i> in global configuration mode. If it is successfully created, a default profile settings is saved.</p> <p>Only one profile is supported globally. To display the enhanced load balancing profile, run show load-balance-profile.</p>

❖ Configuring the Layer-2 Packet Load Balancing Mode

- (Optional) Perform this configuration to specify the Layer-2 packet load balancing mode.
- Perform this configuration on devices that support enhanced load balancing, such as aggregation switches and core switches.

Command	l2 field { [src-mac] [dst-mac] [l2-protocol] [vlan] [src-port] }
Parameter Description	src-mac : Indicates that load is distributed based on the source MAC addresses of incoming Layer-2 packets.

	<p>dst-mac: Indicates that load is distributed based on the destination MAC addresses of incoming Layer-2 packets.</p> <p>I2-protocol: Indicates that load is distributed based on the Layer-2 protocol types of incoming Layer-2 packets.</p> <p>vlan: Indicates that load is distributed based on the VLAN IDs of incoming Layer-2 packets.</p> <p>src-port: Indicates that load is distributed based on the panel port for incoming Layer-2 packets.</p>
Defaults	By default, the load balancing mode of Layer-2 packets is src-mac , dst-mac , and vlan .
Command Mode	Profile configuration mode
Usage Guide	To restore the default settings, run no I2 field in profile configuration mode.

❖ Configuring the IPv4 Packet Load Balancing Mode

- Optional.
- Perform this configuration to specify the IPv4 packet load balancing mode.
- Perform this configuration on devices that support enhanced load balancing, such as aggregation switches and core switches.

Command	ipv4 field { [src-ip] [dst-ip] [protocol] [I4-src-port] [I4-dst-port] [vlan] [src-port] }
Parameter Description	<p>src-ip: Indicates that load is distributed based on the source IP addresses of incoming IPv4 packets.</p> <p>dst-ip: Indicates that load is distributed based on the destination IP addresses of incoming IPv4 packets.</p> <p>protocol: Indicates that load is distributed based on the protocol types of incoming IPv4 packets.</p> <p>I4-src-port: Indicates that load is distributed based on the Layer-4 source port numbers of incoming IPv4 packets.</p> <p>I4-dst-port: Indicates that load is distributed based on the Layer-4 destination port numbers of incoming IPv4 packets.</p> <p>vlan: Indicates that load is distributed based on the VLAN IDs of incoming IPv4 packets.</p> <p>src-port: Indicates that load is distributed based on the panel port for incoming IPv4 packets.</p>
Defaults	By default, the load balancing mode of IPv4 packets is src-ip and dst-ip .
Command Mode	Profile configuration mode
Usage Guide	To restore the default settings, run no ipv4 field in profile configuration mode.

❖ Configuring the IPv6 Packet Load Balancing Mode

- Optional.
- Perform this configuration to specify the IPv6 packet load balancing mode.
- Perform this configuration on devices that support IPv6 packet load balancing, such as aggregation switches and core switches.

Command	ipv6 field { [dst-ip] [protocol] [I4-src-port] [I4-dst-port] [vlan] [src-port] }
----------------	---

Parameter Description	<p>dst-ip: Indicates that load is distributed based on the destination IP addresses of incoming IPv6 packets.</p> <p>protocol: Indicates that load is distributed based on the protocol types of incoming IPv6 packets.</p> <p>I4-src-port: Indicates that load is distributed based on the Layer-4 source port numbers of incoming IPv6 packets.</p> <p>I4-dst-port: Indicates that load is distributed based on the Layer-4 destination port numbers of incoming IPv6 packets.</p> <p>vlan: Indicates that load is distributed based on the VLAN IDs of incoming IPv6 packets.</p> <p>src-port: Indicates that load is distributed according to the source port numbers of incoming IPv6 packets.</p>
Defaults	By default, the load balancing mode of IPv6 packets is src-ip and dst-ip .
Command Mode	Profile configuration mode
Usage Guide	To restore the default settings, run no ipv6 field in profile configuration mode.

❖ Configuring the MPLS Packet Load Balancing Mode

- Optional.
- Perform this configuration to specify the MPLS packet load balancing mode.
- Perform this configuration on devices that support MPLS packet load balancing, such as aggregation switches and core switches.

Command	mpls field { [top-label] [2nd-label] [3rd-label] [src-ip] [dst-ip] [vlan] [src-port] [src-mac] [dst-mac] [protocol] [I4-src-port] [I4-dst-port] [I2-etype] }
Parameter Description	<p>src-ip: Indicates that load is distributed based on the source IP addresses of incoming MPLS packets.</p> <p>dst-ip: Indicates that load is distributed based on the destination IP addresses of incoming MPLS packets.</p> <p>top-label: Indicates that load is distributed based on the top labels of incoming MPLS packets.</p> <p>2nd-label: Indicates that load is distributed based on the second labels of incoming MPLS packets.</p> <p>3rd-label: Indicates that load is distributed based on the third labels of incoming MPLS packets.</p> <p>vlan: Indicates that load is distributed based on the VLAN IDs of incoming MPLS packets.</p> <p>src-port: Indicates that load is distributed based on the source port numbers of incoming MPLS packets.</p> <p>src-mac: Indicates that load is distributed based on the source MAC addresses of incoming MPLS packets.</p> <p>dst-mac: Indicates that load is distributed based on the destination MAC addresses of incoming MPLS packets.</p> <p>protocol: Indicates that load is distributed based on the protocol types of incoming MPLS packets.</p> <p>I4-src-port: Indicates that load is distributed based on the Layer-4 source port numbers of incoming MPLS packets.</p> <p>I4-dst-port: Indicates that load is distributed based on the Layer-4 destination port numbers of incoming MPLS packets.</p> <p>I2-etype: Indicates that load is distributed based on the Ethernet types of MPLS packets.</p>
Defaults	By default, the load balancing mode of MPLS packets is top-label and 2nd-label .

Command Mode	Profile configuration mode
Usage Guide	To restore the default settings, run no mpls field in profile configuration mode.

➤ The MPLS load balancing algorithm takes effect only for MPLS Layer-3 VPN packets.

❖ Configuring the TRILL Packet Load Balancing Mode

- Optional.
- Perform this configuration to specify the TRILL packet load balancing mode.
- Perform this configuration on devices that support TRILL packet load balancing, such as aggregation switches and core switches.

Command	trill field { [vlan] [src-ip] [dst-ip] [src-port] [src-mac] [dst-mac] [I4-src-port] [I4-dst-port] [I2-etype] [protocol] [ing-nick] [egr-nick] }
Parameter Description	<p>vlan: Indicates that load is distributed based on the VLAN IDs of incoming TRILL packets.</p> <p>src-ip: Indicates that load is distributed based on the source IP addresses of incoming TRILL packets.</p> <p>dst-ip: Indicates that load is distributed based on the destination IP addresses of incoming TRILL packets.</p> <p>src-port: Traffic is distributed according to the source port numbers of the incoming TRILL packets.</p> <p>src-mac: Indicates that load is distributed based on the source MAC addresses of incoming TRILL packets.</p> <p>dst-mac: Indicates that load is distributed based on the destination MAC addresses of incoming TRILL packets.</p> <p>I4-src-port: Indicates that load is distributed based on the Layer-4 source port numbers of incoming TRILL packets.</p> <p>I4-dst-port: Indicates that load is distributed based on the Layer-4 destination port numbers of incoming TRILL packets.</p> <p>I2-etype: Indicates that load is distributed based on the Ethernet types of TRILL packets.</p> <p>protocol: Indicates that load is distributed based on the protocol types of incoming TRILL packets.</p> <p>ing-nick: Indicates that load is distributed based on the Ingress Rbridge Nicknames of incoming TRILL packets.</p> <p>egr-nick: Indicates that load is distributed based on the Egress Rbridge Nicknames of incoming TRILL packets.</p>
Defaults	By default, the load balancing mode of TRILL packets is src-mac , dst-mac , and vlan .
Command Mode	Profile configuration mode
Usage Guide	<p>To restore the default settings, run no trill field in profile configuration mode.</p> <p>➤ TRILL Transit RBridge packet flows are balanced based on the following fields: ing-nick, egr-nick, src-mac, dst-mac, vlan, and I2-etype.</p>

	<ul style="list-style-type: none"> ➤ TRILL Egress RBridge packet flows are balanced based on the following fields: Layer-2 packets: src-mac, dst-mac, vlan, and I2- protocol. Layer-3 packets: src-ip, dst-ip, I4-src-port, I4-dst-port, protocol, and vlan. ➤ The src-port and dst-port fields can be used to balance all TRILL Transit RBridge and TRILL Egress RBridge packet flows.
--	---

❖ Configuring the FCoE Packet Load Balancing Mode

- Optional.
- Perform this configuration to specify the FCoE packet load balancing mode.
- Perform this configuration on devices that support FCoE packet load balancing, such as aggregation switches and core switches.

Command	fcoe field {[vlan] [src-port] [src-id] [dst-id] [rx-id] [ox-id] [fabric-id]}
Parameter Description	vlan : Indicates that load is distributed based on the VLAN IDs of incoming FCoE packets. src-port : Indicates that load is distributed based on the source port numbers of incoming FCoE packets. src-id : Indicates that load is distributed based on the source IDs of FCoE packets. dst-id : Indicates that load is distributed based on the destination IDs of FCoE packets. rx-id : Indicates that load is distributed based on the Responder Exchange IDs of FCoE packets. ox-id : Indicates that load is distributed based on the Originator Exchange IDs of FCoE packets. fabric-id : Indicates that load is distributed based on the FC network fabric IDs of FCoE packets.
Defaults	By default, the load balancing mode of FCoE packets is src-id , dst-id , and ox-id .
Command Mode	Profile configuration mode
Usage Guide	To restore the default settings, run no fcoe field in profile configuration mode.

Verification

- Run **show running** to display the configuration.
- Run **show aggregateport load-balance** to display the load balancing configuration. If a device supports load balancing configuration on a specific AP port, run **show aggregateport summary** to display the configuration.
- Run **show load-balance-profile** to display the enhanced load balancing profile.

Command	show aggregateport <i>aggregate-port-number</i> [load-balance summary]
Parameter Description	<i>aggregate-port-number</i> : Indicates the number of an AP port. load-balance : Displays the load balancing algorithm. summary : Displays the summary of each link.
Command Mode	Any mode
Usage Guide	The information on All AP ports is displayed if you do not specify the AP port number.

```
Qtech# show aggregateport 1 summary
```

AggregatePort	MaxPorts	SwitchPort	Mode	Load balance
Ports				
Ag1	8	Enabled	ACCESS	dst-mac
Gi0/2				

Command	show load-balance-profile [<i>profile-name</i>]
Parameter Description	<i>profile-name</i> : Indicates the profile name.
Command Mode	Any mode
Usage Guide	All enhanced profiles are displayed if you do not specify the profile number.
	<pre>Qtech# show load balance profile module0</pre> <p>Load balance profile: module0</p> <p>Packet Hash Field:</p> <p>IPv4: src-ip dst-ip</p> <p>IPv6: src-ip dst-ip</p> <p>L2 : src-mac dst-mac vlan</p> <p>MPLS: top-labe l2nd-label</p>

Configurati on Example

❖ Configuring a Load Balancing Mode

Scenario Figure 3-5	
Configuratio n Steps	<ul style="list-style-type: none"> ➤ Add the GigabitEthernet 1/1 and GigabitEthernet 1/2 ports on Switch A to static AP port 3. ➤ Add the GigabitEthernet 2/1 and GigabitEthernet 2/2 ports on Switch B to static AP port 3. ➤ On Switch A, configure source MAC address-based load balancing for AP port 3

	<p>in global configuration mode.</p> <ul style="list-style-type: none"> ➤ On Switch B, configure destination MAC address-based load balancing for AP port 3 in global configuration mode.
Switch A	<pre>SwitchA# configure terminal SwitchA(config)# interface range GigabitEthernet 1/1 2 SwitchA(config if range)# port group 3 SwitchA(config if range)# exit SwitchA(config)# aggregateport load balance src mac</pre>
Switch B	<pre>SwitchB# configure terminal SwitchB(config)# interface range GigabitEthernet 2/1 2 SwitchB(config if range)# port group 3 SwitchB(config if range)# exit SwitchB(config)# aggregateport load balance dst mac</pre>
Verification	<ul style="list-style-type: none"> ➤ Run show aggregateport load-balance to check the load balancing algorithm configuration.
Switch A	<pre>SwitchA# show aggregatePort load balance Load balance : Source MAC</pre>
Switch B	<pre>SwitchB# show aggregatePort load balance Load balance : Destination MAC</pre>

3.4.5 Configuring an AP Capacity Mode

Configuration Effect

- Change the maximum number of configurable AP ports and the maximum number of member ports in each AP port.

Notes

- The system has a default AP capacity mode. You can run **show aggregateport capacity** to display the current capacity mode.
- If the current configuration (maximum number of AP ports or the number of member ports in each AP port) exceeds the capacity to be configured, the capacity mode configuration will fail.

Configurati on Steps

- ❖ Configuring an AP Capacity Mode
 - (Optional) Perform this configuration to change the AP capacity.
 - Perform this configuration on devices that support AP capacity change, such as core switches.

Command	aggregateport capacity mode <i>capacity-mode</i>
Parameter Description	<i>capacity-mode</i> : Indicates a capacity mode.
Defaults	By default, AP capacity modes vary with devices. For example, 256 x 16 indicates that the device has a maximum of 256 AP ports and 16 member ports in each AP port.
Command Mode	Global configuration mode
Usage Guide	The system provides several capacity modes for devices that support capacity mode configuration. To restore the default settings, run no aggregateport capacity mode in global configuration mode.

Verification

- Run **show running** to display the configuration.
- Run **show aggregateport capacity** to display the current AP capacity mode and AP capacity usage.

Command	show aggregateport capacity
Parameter Description	N/A
Command Mode	Any mode
Usage Guide	N/A
	<pre>Qtech# show aggregateport capacity AggregatePort Capacity Information: Configuration Capacity Mode: 128*16. Effective Capacity Mode : 256*8. Available Capacity : 128*8. Total Number: 128, Used: 1, Available: 127.</pre>

Configurati on Example

- ❖ Configuring an AP Capacity Mode

<p>Scenario Figure 3-6</p>	
<p>Configuration Steps</p>	<ul style="list-style-type: none"> ➤ Add the GigabitEthernet 1/1 and GigabitEthernet 1/2 ports on Switch A to static AP port 3. ➤ Add the GigabitEthernet 2/1 and GigabitEthernet 2/2 ports on Switch B to static AP port 3. ➤ On Switch A, configure the 128 x128 AP capacity mode. ➤ On Switch B, configure the 256 x 64 AP capacity mode.
<p>Switch A</p>	<pre>SwitchA# configure terminal SwitchA(config)# interface range GigabitEthernet 1/1 2 SwitchA(config if range)# port group 3 SwitchA(config if range)# exit SwitchA(config)# aggregateport capacity mode 128*128</pre>
<p>Switch B</p>	<pre>SwitchB# configure terminal SwitchB(config)# interface range GigabitEthernet 2/1 2 SwitchB(config if range)# port group 3 SwitchB(config if range)# exit SwitchB(config)# aggregateport capacity mode 256*64</pre>
<p>Verification</p>	<ul style="list-style-type: none"> ➤ Run show aggregateport capacity to check the AP capacity mode configuration.
<p>Switch A</p>	<pre>SwitchA# show aggregatePort capacity AggregatePort Capacity Information: Configuration Capacity Mode: 128*128. Effective Capacity Mode : 128*128. Available Capacity Mode : 128*128. Total Number : 128, Used: 1, Available: 127.</pre>
<p>Switch B</p>	<pre>SwitchB# show aggregatePort capacity AggregatePort Capacity Information: Configuration Capacity Mode: 256*64.</pre>

```
Effective Capacity Mode : 256*64.  
Available Capacity Mode : 256*64.  
Total Number : 256, Used: 1, Available: 255.
```

3.4.6 Configuring a Preferred AP Member Port

Configurati on Effect

- Configure a member port as the preferred AP member port.
- After the preferred member port is configured, the management VLAN packets on the AP port are forwarded by this port.

Notes

- For details about management VLAN configuration, see *Configuring MAC*.
- Only one preferred member port can be configured for one AP port.
- After an LACP AP member port is configured as the preferred AP member port, if the LACP negotiation on all AP member ports fails, the preferred port is automatically downgraded to a static AP member port.

Configurati on Steps

- ❖ Configuring a Preferred AP Member Port
- (Optional) Perform this configuration to specify an AP member port dedicated to forwarding management VLAN packets.
- The configuration is applicable to dual-system servers. Configure the port connected to the management NIC of the server as the preferred AP member port.

Command	<code>aggregateport primary-port</code>
Parameter Description	N/A
Defaults	By default, No AP member port is a preferred port.
Command Mode	Interface configuration mode of an AP member port
Usage Guide	N/A

Verification

- Run **show running** to display the configuration.
- Run **show interface aggregateport** to display the preferred AP member port.

Command	show interface aggregateport <i>ap-num</i>
Parameter Description	<i>ap-num</i> : Indicates the number of an AP port.
Command Mode	Any mode
Usage Guide	N/A
	<pre>Qtech# show interface aggregateport 11 ... Aggregate Port Informations: Aggregate Number: 11 Name: "AggregatePort 11" Members: (count=2) Primary Port: GigabitEthernet 0/1 GigabitEthernet 0/1 Link Status: Up LACP Status: bndl GigabitEthernet 0/2 Link Status: Up LACP Status: bndl ...</pre>

Configurations on Example

❖ Configuring a Preferred AP Member Port

Scenario Figure 3-7	
Configuration Steps	<ul style="list-style-type: none"> ➤ Enable LACP for the GigabitEthernet 1/1 and GigabitEthernet 1/2 ports on Switch A and add the ports to LACP AP port 3. ➤ Configure the GigabitEthernet 1/1 port on Switch A as a preferred port. ➤ Configure VLAN 10 on Switch A as the management VLAN.
Switch A	<pre>SwitchA# configure terminal SwitchA(config)# interface range GigabitEthernet 1/1 2 SwitchA(config-if range)# port group 3 mode active SwitchA(config-if range)# exit</pre>

	<pre>SwitchA(config)# interface gigabitEthernet 1/1 SwitchA(config if GigabitEthernet 1/1) aggregateport primary port SwitchA(config if GigabitEthernet 1/1)# exit SwitchA(config)# aggregateport admin vlan 10 SwitchA(config)# interface aggregateport 3 SwitchA(config if Aggregateport 3)# switchport mode trunk SwitchA(config if Aggregateport 3)#</pre>
Verification	<ul style="list-style-type: none">➤ Run show run to check whether the configuration takes effect.➤ Run show interface aggregateport to display the preferred AP member port.
Switch A	<pre>SwitchA# show run include GigabitEthernet 1/1 Building configuration... Current configuration: 54 bytes interface GigabitEthernet 1/1 aggregateport primary-port portgroup 3 mode active SwitchA# show interface aggregateport 3 ... Aggregate Port Informations: Aggregate Number: 3 Name: "AggregatePort 3" Members: (count=2) Primary Port: GigabitEthernet 1/1 GigabitEthernet 1/1 Link Status: Up LACP Status: bndl GigabitEthernet 1/2 Link Status: Up LACP Status: bndl ...</pre>

3.4.7 Configuring the Minimum Number of LACP AP Member Ports

Configurati on Effect

- After the minimum number of LACP AP member ports is configured, the aggregation group takes effect only when the number of member ports is greater than the minimum number.

Notes

N/A

Configuration Steps

- ❖ Configuring the Minimum Number of LACP AP Member Ports
 - (Optional) Perform this configuration to specify the minimum number of LACP AP member ports.

Command	<code>aggregateport minimum member number</code>
Parameter Description	<i>number</i> : Indicates the minimum number of member ports.
Defaults	By default, the minimum number of member ports is 0.
Command Mode	Interface configuration mode of the specified AP port
Usage Guide	N/A

Verification

- Run **show running** to display the configuration.
- Run **show interface aggregateport** to display the state of the AP member ports.

Command	<code>show interface aggregateport ap-num</code>
Parameter Description	<i>ap-num</i> : Indicates the number of an AP port.
Command Mode	Any mode
Usage Guide	N/A
	<pre>Qtech# show interface aggregateport 3 ... Aggregate Port Informations: Aggregate Number: 3 Name: "AggregatePort 3" Members: (count=2) GigabitEthernet 0/1 Link Status: Up LACP Status: bndl GigabitEthernet 0/2 Link Status: Up LACP Status: bndl ...</pre>

Configurati on Example

❖ Configuring the Minimum Number of LACP AP Member Ports

<p>Scenario</p> <p>Figure 3-8</p>	
<p>Configuration Steps</p>	<ul style="list-style-type: none"> ➤ Enable LACP for the GigabitEthernet 1/1 and GigabitEthernet 1/2 ports on Switch A and add the ports to LACP AP port 3. ➤ Enable LACP for the GigabitEthernet 2/1 and GigabitEthernet 2/2 ports on Switch B and add the ports to LACP AP port 3. ➤ On Switch A, set the minimum number of the member ports of AP port 3 to 3.
<p>Switch A</p>	<pre>SwitchA# configure terminal SwitchA(config)# interface range GigabitEthernet 1/1 2 SwitchA(config if range)# no switchport SwitchA(config if range)# port group 3 mode active SwitchA(config if range)# exit SwitchA(config)# interface aggregateport 3 SwitchA(config if Aggregateport 3)# aggregateport minimum member 2</pre>
<p>Switch B</p>	<pre>SwitchB# configure terminal SwitchB(config)# interface range GigabitEthernet 1/1 2 SwitchB(config if range)# no switchport SwitchB(config if range)# port group 3 mode active SwitchB(config if range)# exit SwitchB(config)# interface aggregateport 3 SwitchB(config if Aggregateport 3)# aggregateport minimum member 2</pre>
<p>Verification</p>	<ul style="list-style-type: none"> ➤ Run show run to check whether the configuration takes effect. ➤ Run show lacp summery to display the aggregation state of each AP

	member port.
Switch A	<pre>SwitchA# show LACP summary 3 System Id:32768, 08c6.b3fb.0001 Flags: S Device is requesting Slow LACPDUs F Device is requesting Fast LACPDUs. A Device is in active mode. P Device is in passive mode. Aggregate port 3: Local information: LACP port Oper Port Port Port Flags State Priority Key Number State Gi1/1 SA bndl 32768 0x3 0x1 0x3d Gi1/2 SA bndl 32768 0x3 0x2 0x3d Partner information: LACP port Oper Port Port Port Flags Priority Dev ID Key Number State Gi2/1 SA 32768 08c6.b300.0002 0x3 0x1 0x3d Gi2/2 SA 32768 08c6.b300.0002 0x3 0x2 0x3d</pre>

3.5 Monitoring

Displaying

Description	Command
Displays the configuration of an enhanced load balancing profile.	show load-balance-profile [<i>profile-name</i>]
Displays the LACP aggregation state. You can display the information on a specified LACP AP port by specifying <i>key-number</i> .	show lacp summary [<i>key-numebr</i>]
Displays the summary or load balancing algorithm of an AP port.	show aggregateport [<i>ap-number</i>] { load-balance summary }
Displays the capacity mode and usage of an AP port.	show aggregateport capacity

Debugging

⚠ System resources are occupied when debugging information is output. Therefore, disable debugging immediately after use.

Description	Command
Debugs an AP port.	<code>debug lsm ap</code>
Debugs LACP.	<code>debug lacp { packet event database ha realtime stm timer all }</code>

4. CONFIGURING ECMP CLUSTER

4.1 Overview

Equal Cost Multipath (ECMP)-CLUSTER is a technology for implementing load balancing when the next-hop path of ECMP changes.

A load balancing cluster in a data center is usually interconnected to a Top of Rack (TOR) device via ECMP, and the TOR device distributes data traffic in a balanced way to members of the load balancing cluster via ECMP.

If an ECMP route is generated between the TOR device and the load balancing cluster through a dynamic routing protocol, the dynamic routing protocol enables route re-convergence when a link of the ECMP route fails. The traffic from the TOR device to the load balancing cluster is re-balanced, which disturbs the original session status of members in the cluster. As a result, the entire cluster needs to re-establish sessions, causing interruption of some sessions.

ECMP-CLUSTER overcomes traffic re-balancing caused by changes in the ECMP path quantity. After ECMP-CLUSTER is configured, if ECMP paths decrease, only traffic carried on a failed link is balanced to active links and original traffic carried on the active links keep unchanged. If ECMP paths increase, some traffic carried on the active links is distributed to the new links.

When the next hop of ECMP is session-sensitive, that is, the next-hop egress of traffic is a terminal serving device (such as a server), ECMP-CLUSTER is recommended. If the next-hop egress is an intermediate network node, ECMP-CLUSTER is not advantageous.

4.2 Applications

Application	Description
Interconnecting LVS Load Balancing Cluster to TOR Device Via ECMP	The TOR device is interconnected to a session-sensitive server via ECMP.

4.2.1 Interconnecting LVS Load Balancing Cluster to TOR Device Via ECMP

Scenario

As shown in Figure 4-1, the TOR device is interconnected to the Linux Virtual Server (LVS) load balancing cluster via ECMP.

Figure 4-1 Interconnection Between TOR Device and LVS Load Balancing Cluster via ECMP
Ошибка! Не указана последовательность.

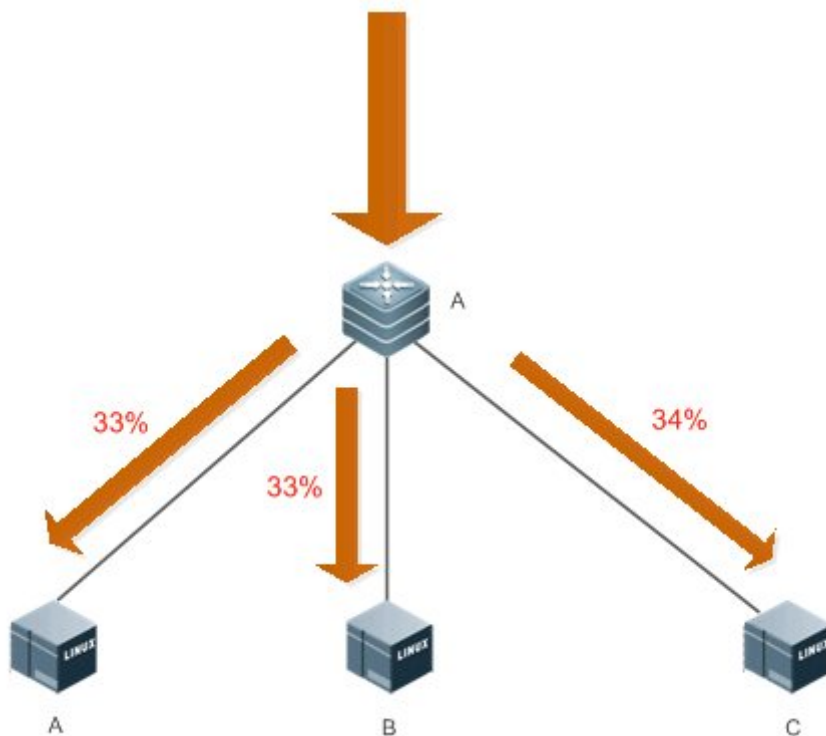

When the link between Device A and Device C fails, the traffic is forwarded as shown in Figure 4-2.

Figure 4-2 Traffic Forwarding

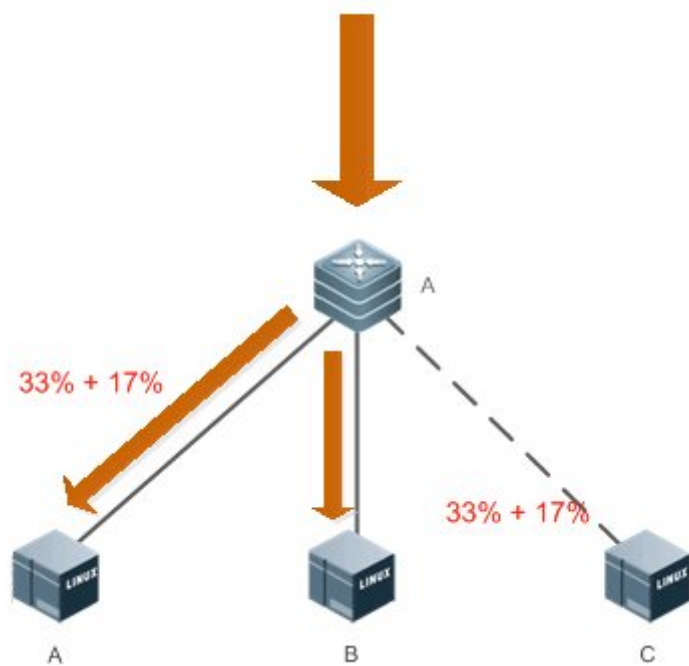

【Note】 A is a TOR switch, and B, C, and D are members of a load balancing cluster.

Deployment

- Run the Open Shortest Path First (OSPF) protocol between the TOR device and members of a load balancing cluster, to implement multipath routing.
- Enable ECMP-CLUSTER on the TOR device.

4.3 Features

Basic Concepts

❖ ECMP Routing

There are multiple routes to a next hop destined for the destination network, for example, the IP address of the destination network is 192.168.0.0/24, and the IP addresses of routers to the next hop include 1.1.1.1, 2.2.2.2, and 3.3.3.3.

Overview

Feature	Description
ECMP CLUSTER	When the next-hop link of an ECMP route changes, maintain load balancing and evenly distributes traffic carried by a failed link to other active links while keeping original traffic carried by the active links unchanged.

Working Principle

Keep the modulo of the hash function used in route calculation unchanged during ECMP routing of packets. Ensure that the total number of next hops remains unchanged during ECMP hardware routing and when a next-hop link of an ECMP route fails, an active link is used to replace the failed link.

4.4 Configuration

Configuration	Description and Command
Configuring ECMP-CLUSTER	(Mandatory) It is used to enable ECMP-CLUSTER.
	<code>ecmp cluster enable</code> Enables ECMP-CLUSTER.

4.4.1 Configuring ECMP-CLUSTER

Configurati on Effect

- Increase or decrease ECMP next hops to minimize impact of original forwarded traffic after ECMP-CLUSTER is enabled.

Notes

- ECMP-CLUSTER is effective to ECMP. Therefore, ECMP must be configured on the network.

Configurati on Steps

❖ Enabling ECMP-CLUSTER

- Mandatory.

【Command】	ecmp cluster enable
【Parameter Description】	N/A
【Defaults】	ECMP-CLUSTER is disabled by default.
【Command Mode】	Global configuration mode
【Usage Guide】	Run the no form of this command to disable ECMP-CLUSTER: no ecmp cluster enable .

Verification

- After ECMP-CLUSTER is enabled, check whether traffic forwarded by multiple paths is balanced.
- After a link fails, check whether traffic carried by the failed link is balanced to other active links, and whether original traffic carried by the active links keeps unchanged.

Configurati on Examples

- Enable ECMP-CLUSTER on a switch and check whether the function is enabled successfully.

```
Qtech(config)#ecmp cluster enable
Qtech(config)#Qtech(config)#show run | in ecmp
ecmp cluster enable
Qtech(config)#
```

4.5 Monitoring

Displaying

Description	Command
Displays whether ECMP-CLUSTER is enabled.	show run



5. CONFIGURING VLAN

5.1 Overview

A Virtual Local Area Network (VLAN) is a logical network created based on a physical network. A VLAN can be categorized into Layer-2 networks of the OSI model.

A VLAN has the same properties as a common LAN, except for physical location limitation. Unicast, broadcast and multicast frames of Layer 2 are forwarded and transmitted within a VLAN, keeping traffic segregated.

We may define a port as a member of a VLAN, and all terminals connected to this port are parts of a virtual network that supports multiple VLANs. You do not need to adjust the network physically when adding, removing and modifying users. Communication among VLANs is realized through Layer-3 devices, as shown in the following figure.

Figure 5-1

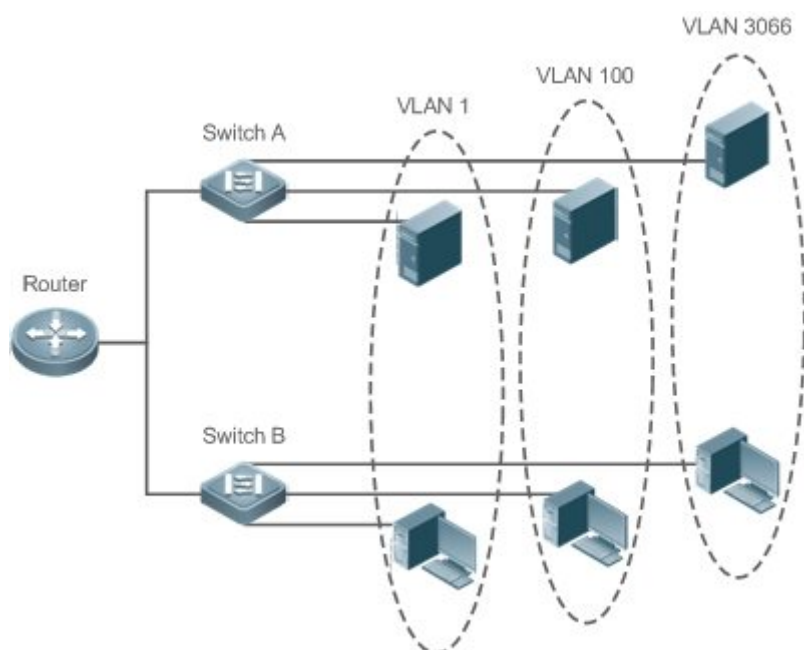

Protocols and Standards

- IEEE 802.1Q

5.2 Applications

Application	Description
Isolating VLANs at Layer 2 and Interconnecting VLANs at Layer 3	An intranet is divided into multiple VLANs, realizing Layer-2 isolation and Layer-3 interconnection with each other through IP forwarding by core switches.

5.2.1 Isolating VLANs at Layer 2 and Interconnecting VLANs at Layer 3

Scenario

An intranet is divided into VLAN 10, VLAN 20 and VLAN 30, realizing Layer-2 isolation from each other. The three VLANs correspond respectively to the IP sub-networks 192.168.10.0/24, 192.168.20.0/24, and 192.168.30.0/24, realizing interconnection with each other through IP forwarding by Layer-3 core switches.

Figure 5-2

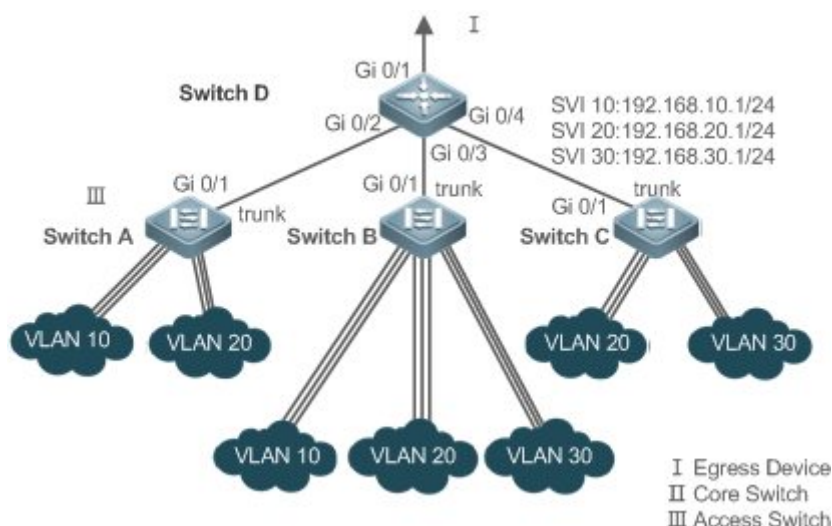

Remarks:	<p>Switch A, Switch B and Switch C are access switches.</p> <p>Configure three VLANs on a core switch and the port connected to the access switches as a Trunk port, and specify a list of allowed-VLANs to realize Layer-2 isolation;</p> <p>Configure three SVIs on the core switch, which are the gateway interfaces of the IP sub-networks corresponding to the three VLANs, and configure the IP addresses for these interfaces.</p> <p>Create VLANs respectively on the three access switches, assign Access ports for the VLANs, and specify Trunk ports of the core switch.</p>
-----------------	---

Deployment

- Divide an intranet into multiple VLANs to realize Layer-2 isolation among them.
- Configure SVIs on a Layer-3 switch to realize Layer-3 communication among VLANs.

5.3 Features

Basic Concepts

❖ VLAN

A VLAN is a logical network created based on a physical network. A VLAN has the same properties as a common LAN, except for physical location limitation. Unicast, broadcast and multicast frames of Layer 2 are forwarded and transmitted within a VLAN, keeping traffic segregated.

- The VLANs supported by Qtech products comply with the IEEE802.1Q standard. A maximum of 4094 VLANs (VLAN ID 1-4094) are supported, among which VLAN 1 cannot be deleted.
- The configurable VLAN IDs are from 1 to 4094.
- In case of insufficient hardware resources, the system returns information on VLAN creation failure.

❖ Port Mode

You can determine the frames allowed to pass a port and the VLANs which the port belongs to by configuring the port mode. See the following table for details.

Port Mode	Description
Access port	An Access port belongs to only one VLAN, which is specified manually.
Trunk port (802.1Q)	A Trunk port belongs to all the VLANs of an access switch by default, and it can forward the frames of all the VLANs or the frames of allowed-VLANs.
Uplink port	An Uplink port belongs to all the VLANs of an access switch by default, and it can forward the frames of all the VLANs and tag the native VLAN egress traffic.
Hybrid port	A Hybrid port belongs to all the VLANs of an access switch by default, and it can forward the frames of all the VLANs and send frames of VLANs untagged. It can also transmit frames of allowed-VLANs.

Overview

Feature	Description
VLAN	VLAN helps realize Layer-2 isolation.

5.3.1 VLAN

Every VLAN has an independent broadcast domain, and different VLANs are isolated on Layer 2.

Working Principle

Every VLAN has an independent broadcast domain, and different VLANs are isolated on Layer 2.

Layer-2 isolation: If no SVIs are configured for VLANs, VLANs are isolated on Layer 2. This means users in these VLANs cannot communicate with each other.

Layer-3 interconnection: If SVIs are configured on a Layer-3 switch for VLANs, these VLANs can communicate with each other on Layer 3.

5.4 Configuration

Configuration	Description and Command
Configuring Basic VLAN	(Mandatory) It is used to create a VLAN.
	vlan Enters a VLAN ID.
	(Optional) It is used to configure an Access port to transmit the flows from a single VLAN.
	switchport mode access Defines a port as a Layer-2 Access port.
	switchport access vlan Assigns a port to a VLAN.
	add interface Adds one Access port or a group of such ports to the current VLAN.
	(Optional) It is used to rename a VLAN.
Configuring a Trunk Port	(Mandatory) It is used to configure the port as a Trunk port.
	switchport mode trunk Defines a port as a Layer-2 Trunk port.
	(Optional) It is used to configure Trunk ports to transmit flows from multiple VLANs.
	switchport trunk allowed vlan Configures allowed-VLANs for a Trunk port.
	switchport trunk native vlan Specifies a native VLAN for a Trunk port.
Configuring an Uplink Port	(Mandatory) It is used to configure the port as an Uplink port.
	switchport mode uplink Configures a port as an Uplink port.
	(Optional) It is used to restore the port mode.
Configuring a Hybrid Port	(Mandatory) It is used to configure a port as a Hybrid port.
	switchport mode hybrid Configures a port as a Hybrid port.
	(Optional) It is used to transmit the frames of multiple VLANs untagged.
	no switchport mode Restores the port mode.
	switchport hybrid allowed vlan Configures allowed-VLANs for a Hybrid port.
switchport hybrid native vlan Configures a default VLAN for a Hybrid port.	

5.4.1 Configuring Basic VLAN

Configurati on Effect

- A VLAN is identified by a VLAN ID. You may add, delete, modify VLANs 2 to 4094, but VLAN 1 is created automatically and cannot be deleted. You may configure the port mode, and add or remove a VLAN.

Notes

- N/A

Configurati on Steps

- ❖ Creating and Modifying a VLAN
 - Mandatory.
 - In case of insufficient hardware resources, the system returns information on VLAN creation failure.
 - Use the **vlan *vlan-id*** command to create a VLAN or enter VLAN mode.
 - Configuration:

Command	vlan <i>vlan-id</i>
Parameter Description	<i>vlan-id</i> : indicates VLAN ID ranging from 1 to 4094.
Defaults	VLAN 1 is created automatically and is not deletable.
Command Mode	Global configuration mode
Usage Guide	If you enter a new VLAN ID, the corresponding VLAN will be created. If you enter an existing VLAN ID, the corresponding VLAN will be modified. You may use the no vlan <i>vlan-id</i> command to delete a VLAN. The undeletable VLANs include VLAN1, the VLANs configured with SVIs, and SubVLANs.

- ❖ Renaming a VLAN
 - Optional.
 - You cannot rename a VLAN the same as the default name of another VLAN.
 - Configuration:

Command	name <i>vlan-name</i>
Parameter Description	<i>vlan-name</i> : indicates a VLAN name.
Defaults	By default, the name of a VLAN is its VLAN ID. For example, the default name of the VLAN 4 is VLAN 0004.
Command Mode	VLAN configuration mode
Usage Guide	To restore the VLAN name to defaults, use the no name command.

❖ Assigning Current Access port to a Specified VLAN

- Optional.
- Use the **switchport mode access** command to specify Layer-2 ports (switch ports) as Access ports.
- Use the **switchport access vlan** *vlan-id* command to add an Access port to a specific VLAN so that the flows from the VLAN can be transmitted through the port.
- Configuration:

Command	switchport mode access
Parameter Description	N/A
Defaults	A switch port is an Access port by default.
Command Mode	Interface configuration mode
Usage Guide	N/A

Command	switchport access vlan <i>vlan-id</i>
Parameter Description	<i>vlan-id</i> : indicates a VLAN ID.
Defaults	An Access port is added to VLAN 1 by default.
Command Mode	Interface configuration mode
Usage Guide	If a port is assigned to a non-existent VLAN, the VLAN will be created automatically.

❖ Adding an Access Port to Current VLAN

- Optional.
- This command takes effect only on an Access port. After an Access port is added to a VLAN, the flows of the VLAN can be transmitted through the port.
- Configuration:



Command	add interface { <i>interface-id</i> range <i>interface-range</i> }
Parameter	<i>interface-id</i> : indicates a single port.
Description	<i>interface-id</i> : indicates multiple ports.
Defaults	By default, all Layer-2 Ethernet ports belong to VLAN 1.
Command Mode	VLAN configuration mode
Usage Guide	In VLAN configuration mode, add a specific Access port to a VLAN. This command takes the same effect as command switchport access vlan <i>vlan-id</i> .

- For the two commands of adding a port to a VLAN, the command configured later will overwrite the other one.

Verification

- Send untagged packets to an Access port, and they are broadcast within the VLAN.
- Use commands **show vlan** and **show interface switchport** to check whether the configuration takes effect.

Command	show vlan [id <i>vlan-id</i>]						
Parameter Description	<i>vlan-id</i> : indicates a VLAN ID.						
Command Mode	Any mode						
Usage Guide	N/A						
Command Display	<pre>Qtech(config vlan)#show vlan id 20</pre> <table border="1"> <thead> <tr> <th>VLAN Name</th> <th>Status</th> <th>Ports</th> </tr> </thead> <tbody> <tr> <td>20 VLAN0020</td> <td>STATIC</td> <td>Gi0/1</td> </tr> </tbody> </table>	VLAN Name	Status	Ports	20 VLAN0020	STATIC	Gi0/1
VLAN Name	Status	Ports					
20 VLAN0020	STATIC	Gi0/1					

Configuration Example

❖ Configuring Basic VLAN and Access Port

Configuration Steps	<p>➤ Create a VLAN and rename it.</p> <p>➤ Add an Access port to the VLAN. There are two approaches. One is:</p>
	<pre>Qtech# configure terminal Qtech(config)# vlan 888 Qtech(config vlan)# name test888</pre>

	<pre>Qtech# configure terminal Qtech(config)# interface GigabitEthernet 0/3 Qtech(config if GigabitEthernet 0/3)# switchport mode access Qtech(config if GigabitEthernet 0/3)# switchport access vlan 20</pre> <p>The other approach is adding an Access port (GigabitEthernet 0/3) to VLAN20:</p> <pre>Qtech# configure terminal SwitchA(config)#vlan 20 SwitchA(config vlan)#add interface GigabitEthernet 0/3</pre>																								
Verification	Check whether the configuration is correct.																								
	<pre>Qtech(config vlan)#show vlan</pre> <table border="1"> <thead> <tr> <th>VLAN Name</th> <th>Status</th> <th>Ports</th> </tr> </thead> <tbody> <tr> <td>1 VLAN0001</td> <td>STATIC</td> <td></td> </tr> <tr> <td>20 VLAN0020</td> <td>STATIC</td> <td>Gi0/3</td> </tr> <tr> <td>888 test888</td> <td>STATIC</td> <td></td> </tr> </tbody> </table> <pre>Qtech(config vlan)# Qtech# show interface GigabitEthernet 0/3 switchport</pre> <table border="1"> <thead> <tr> <th>Interface</th> <th>Switchport Mode</th> <th>Access</th> <th>Native</th> </tr> </thead> <tbody> <tr> <td>GigabitEthernet 0/3</td> <td>enabled</td> <td>ACCESS</td> <td>20</td> </tr> <tr> <td>Disabled</td> <td>ALL</td> <td></td> <td></td> </tr> </tbody> </table>	VLAN Name	Status	Ports	1 VLAN0001	STATIC		20 VLAN0020	STATIC	Gi0/3	888 test888	STATIC		Interface	Switchport Mode	Access	Native	GigabitEthernet 0/3	enabled	ACCESS	20	Disabled	ALL		
VLAN Name	Status	Ports																							
1 VLAN0001	STATIC																								
20 VLAN0020	STATIC	Gi0/3																							
888 test888	STATIC																								
Interface	Switchport Mode	Access	Native																						
GigabitEthernet 0/3	enabled	ACCESS	20																						
Disabled	ALL																								

5.4.2 Configuring a Trunk Port

Configurati on Effect

A Trunk is a point-to-point link connecting one Ethernet interface or multiple ones to other network devices (for example, a router or switch) and it may transmit the flows from multiple VLANs.

The Trunk of Qtech devices adopts the 802.1Q encapsulation standard. The following figure displays a network adopting a Trunk connection.

Figure 5-3

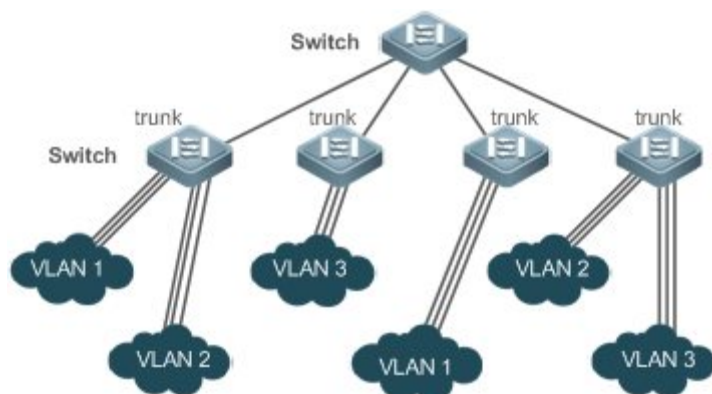

You may configure an Ethernet port or Aggregate Port (See *Configuring Aggregate Port* for details) as a Trunk port.

You should specify a native VLAN for a Trunk port. The untagged packets received by and sent from the Trunk port are considered to belong to the native VLAN. The default VLAN ID (PVID in the IEEE 802.1Q) of this Trunk port is the native VLAN ID. Meanwhile, frames of the native VLAN sent via the Trunk are untagged. The default native VLAN of a Trunk port is VLAN 1.

When configuring a Trunk link, make sure the Trunk ports at the two ends of the link adopt the same native VLAN.

Configuration Steps

❖ Configuring a Trunk Port

- Mandatory.
- Configure a Trunk port to transmit the flows from multiple VLANs.
- Configuration:

Command	<code>switchport mode trunk</code>
Parameter Description	N/A
Defaults	The default mode is Access, which can be modified to Trunk.
Command Mode	Interface configuration mode
Usage Guide	To restore all properties of a Trunk port to defaults, use the no switchport mode command.

❖ Defining Allowed-VLANs for a Trunk Port

- Optional.
- By default, a trunk port transmits the flows from all the VLANs (1 to 4094). You may configure a list of allowed-VLANs to prohibit flows of some VLANs from passing through a Trunk port.
- Configuration:

Command	switchport trunk allowed vlan { all [add remove except only] } vlan-list
Parameter Description	The parameter <i>vlan-list</i> can be a VLAN or some VLANs, and the VLAN IDs are connected by "-" in order. For example: 10–20. all indicates allowed-VLANs include all VLANs; add indicates adding a specific VLAN to the list of allowed-VLANs; remove indicates removing a specific VLAN from the list of allowed-VLANs; except indicates adding all VLANs except those in the listed VLAN to the list of allowed-VLANs. only indicates adding the listed VLANs to the list of allowed-VLANs, and removing the other VLANs from the list.
Defaults	The Trunk port and the Uplink port belong to all VLANs.
Command Mode	Interface configuration mode
Usage Guide	To restore the configuration on a Trunk port to defaults (all), use the no switchport trunk allowed vlan command.

❖ Configuring a Native VLAN

- Optional.
- A Trunk port receives and sends tagged or untagged 802.1Q frames. Untagged frames transmit the flows from the native VLAN. The default native VLAN is VLAN 1.
- If a frame carries the VLAN ID of a native VLAN, its tag will be stripped automatically when it passes a Trunk port.
- Configuration:

Command	switchport trunk native vlan vlan-id
Parameter Description	<i>vlan-id</i> : indicates a VLAN ID.
Defaults	The default VALN for a Trunk/Uplink port is VLAN 1.
Command Mode	Interface configuration mode
Usage Guide	To restore the native VLAN of a Trunk port back to defaults, use the no switchport trunk native vlan command.

- When you set the native VLAN of a port to a non-existent VLAN, this VLAN will not be created automatically. Besides, the native VLAN can be out of the list of allowed-VLANs for this port. In this case, the flows from the native VLAN cannot pass through the port.

Verification

- Send tag packets to a Trunk port, and they are broadcast within the specified VLANs.
- Use commands **show vlan** and **show interface switchport** to check whether the configuration takes effect.

Command	show vlan [id <i>vlan-id</i>]						
Parameter Description	<i>vlan-id</i> : indicates a VLAN ID.						
Command Mode	Any mode						
Usage Guide	N/A						
Command Display	<pre>Qtech(config vlan)#show vlan id 20</pre> <table border="1"> <thead> <tr> <th>VLAN Name</th> <th>Status</th> <th>Ports</th> </tr> </thead> <tbody> <tr> <td>20 VLAN0020</td> <td>STATIC</td> <td>Gi0/1</td> </tr> </tbody> </table>	VLAN Name	Status	Ports	20 VLAN0020	STATIC	Gi0/1
VLAN Name	Status	Ports					
20 VLAN0020	STATIC	Gi0/1					

Configuration Example

❖ Configuring Basic VLAN to Realize Layer-2 Isolation and Layer-3 Interconnection

<p>Scenario Figure 5-4</p>	<p>The diagram illustrates a network topology for Layer-2 isolation and Layer-3 interconnection. It features three access switches (Switch A, Switch B, and Switch C) and one core switch (Switch D). Each access switch is connected to the core switch via a trunk link (Gi 0/1). Switch A and Switch B each have two VLANs (VLAN 10 and VLAN 20) connected to them. Switch C has two VLANs (VLAN 20 and VLAN 30) connected to it. The core switch (Switch D) has three SVI interfaces: SVI 10 (192.168.10.1/24), SVI 20 (192.168.20.1/24), and SVI 30 (192.168.30.1/24). A legend indicates that I represents an Egress Device, II represents a Core Switch, and III represents an Access Switch.</p>
<p>Configuration Steps</p>	<p>Networking Requirements: As shown in the figure above, an intranet is divided into VLAN 10, VLAN 20 and VLAN 30, realizing Layer-2 isolation from each other. The three VLANs correspond respectively to the IP sub-networks 192.168.10.0/24, 192.168.20.0/24, and 192.168.30.0/24, realizing interconnection with each other through IP forwarding by Layer-3 core switches.</p> <p>Key Points:</p>

The following example describes the configuration steps on a core switch and an access switch.

- Configure three VLANs on a core switch and the port connected to the access switches as a Trunk port, and specify a list of allowed-VLANs to realize Layer-2 isolation.
- Configure three SVIs on the core switch, which are the gateway interfaces of the IP sub-networks corresponding to the three VLANs, and configure the IP addresses for these interfaces.
- Create VLANs respectively on the three access switches, assign Access ports for the VLANs, and specify Trunk ports of the core switch. The following example describes the configuration steps on Switch A.

D

```
D#configure terminal
D(config)#vlan 10
D(config vlan)#vlan 20
D(config vlan)#vlan 30
D(config vlan)#exit
D(config)#interface range GigabitEthernet 0/2 4
D(config if range)#switchport mode trunk
D(config if range)#exit
D(config)#interface GigabitEthernet 0/2
D(config if GigabitEthernet 0/2)#switchport trunk allowed vlan remove
1 4094
D(config if GigabitEthernet 0/2)#switchport trunk allowed vlan add 10,20
D(config if GigabitEthernet 0/2)#interface GigabitEthernet 0/3
D(config if GigabitEthernet 0/2)#switchport trunk allowed vlan remove
1 4094
D(config if GigabitEthernet 0/2)#switchport trunk allowed vlan add
10,20,30
D(config if GigabitEthernet 0/2)#interface GigabitEthernet 0/4
D(config if GigabitEthernet 0/2)#switchport trunk allowed vlan remove
1 4094
D(config if GigabitEthernet 0/2)#switchport trunk allowed vlan add 20,30
D#configure terminal
D(config)#interface vlan 10
D(config if VLAN 10)#ip address 192.168.10.1 255.255.255.0
D(config if VLAN 10)#interface vlan 20
D(config if VLAN 20)#ip address 192.168.20.1 255.255.255.0
```

	<pre>D(config if VLAN 20)#interface vlan 30 D(config if VLAN 30)#ip address 192.168.30.1 255.255.255.0 D(config if VLAN 30)#exit</pre>
A	<pre>A#configure terminal A(config)#vlan 10 A(config vlan)#vlan 20 A(config vlan)#exit A(config)#interface range GigabitEthernet 0/2 12 A(config if range)#switchport mode access A(config if range)#switchport access vlan 10 A(config if range)#interface range GigabitEthernet 0/13 24 A(config if range)#switchport mode access A(config if range)#switchport access vlan 20 A(config if range)#exit A(config)#interface GigabitEthernet 0/1 A(config if GigabitEthernet 0/1)#switchport mode trunk</pre>
Verification	<p>Display the VLAN configuration on the core switch.</p> <ul style="list-style-type: none"> ➤ Display VLAN information including VLAN IDs, VLAN names, status and involved ports. ➤ Display the status of ports Gi 0/2, Gi 0/3 and Gi 0/4.
D	<pre>D#show vlan VLAN Name Status Ports ----- 1 VLAN0001 STATIC Gi0/1, Gi0/5, Gi0/6, Gi0/7 Gi0/8, Gi0/9, Gi0/10, Gi0/11 Gi0/12, Gi0/13, Gi0/14, Gi0/15 Gi0/16, Gi0/17, Gi0/18, Gi0/19 Gi0/20, Gi0/21, Gi0/22, Gi0/23 Gi0/24 10 VLAN0010 STATIC Gi0/2, Gi0/3 20 VLAN0020 STATIC Gi0/2, Gi0/3, Gi0/4 30 VLAN0030 STATIC Gi0/3, Gi0/4</pre>

```

D#show interface GigabitEthernet 0/2 switchport
Interface                Switchport Mode      Access Native Protected
VLAN lists

GigabitEthernet 0/2      enabled  TRUNK    1    1    Disabled
10,20

D#show interface GigabitEthernet 0/3 switchport
Interface                Switchport Mode      Access Native Protected
VLAN lists

GigabitEthernet 0/3      enabled  TRUNK    1    1    Disabled
10,20,30

D#show interface GigabitEthernet 0/4 switchport
Interface                Switchport Mode      Access Native Protected
VLAN lists

GigabitEthernet 0/4      enabled  TRUNK    1    1    Disabled
20,30

```

Common Errors

- N/A

5.4.3 Configuring an Uplink Port

Configuration Effect

- An Uplink port is usually used in QinQ (the IEEE 802.1ad standard) environment, and is similar to a Trunk port. Their difference is that an Uplink port only transmits tagged frames while a Trunk port sends untagged frames of the native VLAN.

Configuration Steps

- ❖ Configuring an Uplink Port
- Mandatory.



- Configure an Uplink port to transmit the flows from multiple VLANs, but only tagged frames can be transmitted.
- Configuration:

Command	switchport mode uplink
Parameter Description	N/A
Defaults	The default mode is Access, which can be modified to Uplink.
Command Mode	Interface configuration mode
Usage Guide	To restore all properties of an Uplink port to defaults, use the no switchport mode command.

❖ Defining Allowed-VLANs for a Trunk Port

- Optional.
- You may configure a list of allowed-VLANs to prohibit flows of some VLANs from passing through an Uplink port.
- Configuration:

Command	switchport trunk allowed vlan { all [add remove except only] } <i>vlan-list</i>
Parameter Description	The parameter <i>vlan-list</i> can be a VLAN or some VLANs, and the VLAN IDs are connected by "-" in order. For example: 10–20. all indicates allowed-VLANs include all VLANs; add indicates adding a specific VLAN to the list of allowed-VLANs; remove indicates removing a specific VLAN from the list of allowed-VLANs; except indicates adding all VLANs except those in the listed VLAN to the list of allowed-VLANs; and only indicates adding the listed VLANs to the list of allowed-VLANs, and removing the other VLANs from the list.
Command Mode	Interface configuration mode
Usage Guide	To restore the allowed-VLANs to defaults (all), use the no switchport trunk allowed vlan command.

❖ Configuring a Native VLAN

- Optional.
- If a frame carries the VLAN ID of a native VLAN, its tag will not be stripped when it passes an Uplink port. This is contrary to a Trunk port.
- Configuration:

Command	switchport trunk native vlan <i>vlan-id</i>
Parameter	<i>vlan-id</i> : indicates a VLAN ID.

Description	
Command Mode	Interface configuration mode
Usage Guide	To restore the native VLAN of an Uplink to defaults, use the no switchport trunk native vlan command.

Verification

- Send tag packets to an Uplink port, and they are broadcast within the specified VLANs.
- Use commands **show vlan** and **show interface switchport** to check whether the configuration takes effect.

Command	show vlan [id <i>vlan-id</i>]						
Parameter Description	<i>vlan-id</i> : indicates a VLAN ID.						
Command Mode	Any mode						
Usage Guide	N/A						
Command Display	<pre>Qtech(config vlan)#show vlan id 20</pre> <table border="1"> <thead> <tr> <th>VLAN Name</th> <th>Status</th> <th>Ports</th> </tr> </thead> <tbody> <tr> <td>20 VLAN0020</td> <td>STATIC</td> <td>Gi0/1</td> </tr> </tbody> </table>	VLAN Name	Status	Ports	20 VLAN0020	STATIC	Gi0/1
VLAN Name	Status	Ports					
20 VLAN0020	STATIC	Gi0/1					

Configuration Example

❖ Configuring an Uplink Port

Configuration Steps	The following is an example of configuring Gi0/1 as an Uplink port.						
	<pre>Qtech# configure terminal Qtech(config)# interface gi 0/1 Qtech(config if GigabitEthernet 0/1)# switchport mode uplink Qtech(config if GigabitEthernet 0/1)# end</pre>						
Verification	Check whether the configuration is correct.						
	<pre>Qtech# show interfaces GigabitEthernet 0/1 switchport</pre> <table border="1"> <thead> <tr> <th>Interface</th> <th>Switchport Mode</th> <th>Access Native</th> </tr> </thead> <tbody> <tr> <td></td> <td></td> <td></td> </tr> </tbody> </table>	Interface	Switchport Mode	Access Native			
Interface	Switchport Mode	Access Native					



Protected VLAN lists
GigabitEthernet 0/1 enabled UPLINK 1 1
disabled ALL

5.4.4 Configuring a Hybrid Port

Configurati on Effect

- A Hybrid port is usually used in SHARE VLAN environment. By default, a Hybrid port is the same as a Trunk port. Their difference is that a Hybrid port can send the frames from the VLANs except the default VLAN in the untagged format.

Configurati on Steps

- ❖ Configuring a Hybrid Port
 - Mandatory.
 - Configure a Hybrid port to transmit the flows from multiple VLANs.
 - Configuration:

Command	switchport mode hybrid
Parameter Description	N/A
Defaults	The default mode is Access, which can be modified to Hybrid.
Command Mode	Interface configuration mode
Usage Guide	To restore all properties of a Hybrid port to defaults, use the no switchport mode command.

- ❖ Defining Allowed-VLANs for a Hybrid Port
 - Optional.
 - By default, a Hybrid port transmits the flows from all the VLANs (1 to 4094). You may configure a list of allowed-VLANs to prohibit flows of some VLANs from passing through a Hybrid port.
 - Configuration:

Command	switchport hybrid allowed vlan [[add only] tagged untagged remove] <i>vlan_list</i>
Parameter Description	<i>vlan-id</i> : indicates a VLAN ID.



Defaults	By default a Hybrid port belongs to all VLANs. The port is added to the default VLAN in untagged form and to the other VLANs in the tagged form.
Command Mode	Interface configuration mode
Usage Guide	N/A

❖ Configuring a Native VLAN

- Optional.
- If a frame carries the VLAN ID of a native VLAN, its tag will be stripped automatically when it passes a Hybrid port.
- Configuration:

Command	switchport hybrid native vlan <i>vlan_id</i>
Parameter Description	<i>vlan-id</i> : indicates a VLAN ID.
Defaults	The default native VLAN is VLAN 1.
Command Mode	Interface configuration mode
Usage Guide	To restore the native VLAN of a Hybrid port to defaults, use the no switchport hybrid native vlan command.

Verification

- Send tagged packets to an Hybrid port, and they are broadcast within the specified VLANs.
- Use commands **show vlan** and **show interface switchport** to check whether the configuration takes effect.

Command	show vlan [id <i>vlan-id</i>]						
Parameter Description	<i>vlan-id</i> : indicates a VLAN ID.						
Command Mode	Any mode						
Usage Guide	N/A						
Command Display	<pre>Qtech(config vlan)#show vlan id 20</pre> <table border="1"> <thead> <tr> <th>VLAN Name</th> <th>Status</th> <th>Ports</th> </tr> </thead> <tbody> <tr> <td>20 VLAN0020</td> <td>STATIC</td> <td>Gi0/1</td> </tr> </tbody> </table>	VLAN Name	Status	Ports	20 VLAN0020	STATIC	Gi0/1
VLAN Name	Status	Ports					
20 VLAN0020	STATIC	Gi0/1					

Configurati on Example

❖ Configuring a Hybrid Port

Configuratio n Steps	The following is an example of configuring Gi0/1 as a Hybrid port.
	<pre>Qtech# configure terminal Qtech(config)# interface gigabitEthernet 0/1 Qtech(config if GigabitEthernet 0/1)# switchport mode hybrid Qtech(config if GigabitEthernet 0/1)# switchport hybrid native vlan 3 Qtech(config if GigabitEthernet 0/1)# switchport hybrid allowed vlan untagged 20 30 Qtech(config if GigabitEthernet 0/1)# end</pre>
Verification	Check whether the configuration is correct.
	<pre>Qtech(config if GigabitEthernet 0/1)#show run interface gigabitEthernet 0/1 Building configuration... Current configuration : 166 bytes interface GigabitEthernet 0/1 switchport switchport mode hybrid switchport hybrid native vlan 3 switchport hybrid allowed vlan add untagged 20-30</pre>

5.5 Monitoring

Displaying

Description	Command
Displays VLAN configuration.	show vlan
Displays configuration of switch ports.	show interface switchport



Debugging

System resources are occupied when debugging information is output. Disable the debugging switch immediately after use.

Description	Command
Debugs VLANs.	<code>debug bridge vlan</code>



6. CONFIGURING MAC VLAN

6.1 Overview

The MAC VLAN function refers to assigning VLANs based on MAC addresses, which is a new method of VLAN assignment. This function is often used with 802.1Xdynamic VLAN assignment to implement secure and flexible access of 802.1Xterminals. After an 802.1Xuser passes authentication, the access switch automatically generates a MAC VLAN entry based on the VLAN and user MAC address pushed by the authentication server. A network administrator can also configure the association between a MAC address and a VLAN on the switch in advance.

Protocols

- IEEE 802.1Q: Virtual Bridged Local Area Networks and Standards

6.2 Applications

Application	Description
Configuring MAC VLAN	Configures the MAC VLAN function to assign VLANs based on users' MAC addresses. When the physical location of a user changes, i.e. switching from one switch to another, it is unnecessary to re-configure the VLAN of the port used by the user.

6.2.1 Configuring MAC VLAN

Scenario

With popularization of mobile office, terminal devices usually do not use fixed ports for network access. A terminal device may use port A to access the network this time, but use port B to access the network next time. If the VLAN configurations of ports A and B are different, the terminal device will be assigned to a different VLAN in the second access, and fail to use the resources of the previous VLAN. If the VLAN configurations of ports A and B are the same, security issues may be introduced when port B is assigned to other terminal devices. How to allow hosts of different VLANs to access the network on the same port? The MAC VLAN function is hereby introduced.

The biggest advantage of MAC VLAN lies in that when the physical location of a user changes, i.e. switching from one switch to another, it is unnecessary to re-configure the VLAN of the port used by the user. Therefore, MAC address-based VLAN assignment can be regarded as user-based.

Deployment

- Configure or push MAC VLAN entries on a layer-2 switch or wireless device to assign VLANs based on users' MAC addresses.

6.3 Overview

Feature

Feature	Description
Configuring MAC VLAN	Configures the MAC VLAN function to assign VLANs based on users' MAC addresses.

6.3.1 Configuring MAC VLAN

Working Principle

When a switch receives a packet, the switch compares the source MAC address of the packet with the MAC address specified in a MAC VLAN entry. If they match, the switch forwards the packet to the VLAN specified in the MAC VLAN entry. If they don't match, the VLAN to which the data stream belongs is still determined by the VLAN assignment rule of the port.

To ensure that a PC is assigned to a specified VLAN no matter which switch it is connected to, you can perform configuration by using the following approaches:

- Static configuration by using commands. You can configure the association between a MAC address and a VLAN on a local switch by using commands.
- Automatic configuration by using an authentication server (802.1Xdynamic VLAN assignment). After a user passes authentication, a switch dynamically creates an association between the MAC address and a VLAN based on the information provided by the authentication server. When the user goes offline, the switch automatically deletes the association. This approach requires that the MAC-VLAN association be configured on the authentication server. For details about 802.1Xdynamic VLAN assignment, refer to the Configuring 802.1X.

MAC VLAN entries support both of the two approaches, that is, the entries can be configured on both a local switch and an authentication server. The configurations can take effect only if they are consistent. If the configurations are different, the configuration performed earlier takes effect.

- The MAC VLAN function can be configured on hybrid ports only.
- MAC VLAN entries are effective only for untagged packets, but not effective for tagged packets.
- For MAC VLAN entries statically configured or dynamically generated, the specified VLANs must exist.
- VLANs specified in MAC VLAN entries cannot be Super VLANs (but can be Sub VLANs), Remote VLANs, or Primary VLANs (but can be Secondary VLANs).
- MAC addresses specified in MAC VLAN entries must be unicast addresses.

- MAC VLANs are effective for all hybrid ports that are enabled with the MAC VLAN function.

6.4 Configuration

Configuration	Description and Command
Enabling MAC VLAN on a Port	(Mandatory) It is used to enable the MAC VLAN function on a port.
	<code>mac-vlan enable</code> Enables MAC VLAN on a port.
Adding a Static MAC VLAN Entry Globally	(Optional) It is used to bind MAC addresses with VLANs.
	<code>mac-vlan mac-address</code> Configures a static MAC VLAN entry.

6.4.1 Enabling MAC VLAN on a Port

[Configuration Effect](#)

Enable the MAC VLAN function on a port so that MAC VLAN entries can take effect on the port.

[Notes](#)

N/A

[Configuration Steps](#)

- ❖ Enabling MAC VLAN on a Port
 - Mandatory.
 - By default, the MAC VLAN function is disabled on ports and all MAC VLAN entries are ineffective on the ports.
 - Enable MAC VLAN on a switch.

Command	<code>mac-vlan enable</code>
Parameter	N/A
Description	
Defaults	The MAC VLAN function is disabled on a port.
Command Mode	Interface configuration mode
Usage Guide	N/A

[Verification](#)

- Run the **show mac-vlan interface** command to display information about the ports enabled with the MAC VLAN function.

Command	show mac-vlan interface
Parameter Description	N/A
Command Mode	Privileged configuration mode/Global configuration mode/Interface configuration mode
Usage Guide	N/A
Command Display	<pre>Qtech# show mac vlan interface MAC VLAN is enabled on following interface: FastEthernet 0/1</pre>

[Configurati on Example](#)

❖ Enabling MAC VLAN on a Port

Configuration Steps	<ul style="list-style-type: none"> ➤ Enable the MAC VLAN function on the Fast Ethernet 0/10 port.
	<pre>Qtech# configure terminal Qtech(config)# interface FastEthernet0/10 Qtech(config if FastEthernet 0/10)# mac vlan enable</pre>
Verification	<ul style="list-style-type: none"> ➤ Check the information about the port enabled with the MAC VLAN function.
	<pre>Qtech# show mac vlan interface MAC VLAN is enabled on following interface: FastEthernet 0/10</pre>

[Common Errors](#)

When the MAC VLAN function is enabled on a port, the port is not configured as a layer-2 port (such as switch port or AP port) in advance.

6.4.2 Adding a Static MAC VLAN Entry Globally

[Configurati on Effect](#)

- Configure a static MAC VLAN entry to bind a MAC addresses with a VLAN. The 802.1p priority can be configured, which is 0 by default.

Notes

N/A

Configuration Steps

❖ Adding a Static MAC VLAN Entry

- Optional.
- To bind a MAC addresses with a VLAN, you should perform this configuration. The 802.1p priority can be configured, which is 0 by default.
- Add a static MAC VLAN entry on a switch.

Command	mac-vlan mac-address <i>mac-address</i> [mask <i>mac-mask</i>] vlan <i>vlan-id</i> [priority <i>pri_val</i>]
Parameter	mac-address <i>mac-address</i> : Indicates a MAC address.
Description	mask <i>mac-mask</i> : Indicates a mask. vlan <i>vlan-id</i> : Indicates the associated VLAN. priority <i>pri_val</i> : Indicates the priority.
Defaults	No static MAC VLAN entry is configured by default.
Command Mode	Global configuration mode
Usage Guide	N/A

- If an untagged packet is matched with a MAC VLAN entry, the packet is modified to the VLAN specified by the MAC VLAN entry once arriving at the switch since the MAC VLAN entry has the highest priority. Subsequent functions and protocols are implemented based on the modified VLAN. Possible influences are as follows:
 - If an 802.1X user fails to be authenticated, the hybrid port jumps to VLAN 100 specified by the FAIL VLAN function; however, the MAC VLAN entry statically configured redirects all packets of this user to VLAN 200. Consequently, the user cannot implement normal communication in FAIL VLAN 100.
 - After an untagged packet is matched with a MAC VLAN entry, the VLAN that triggers MAC address learning is the VLAN redirected based on the MAC VLAN entry.
 - For a port that is enabled with the MAC VLAN function, if received packets are matched with both MAC VLAN entries with full F masks and those without full F masks, the packets are processed based on the MAC VLAN entries without full F masks.
 - If an untagged packet is matched with both a MAC VLAN entry and a VOICE VLAN entry, the packet priority is modified simultaneously. The priority of the VOICE VLAN entry is used as that of the packet.
 - If an untagged packet is matched with both a MAC VLAN entry and a PROTOCOL VLAN entry, the VLAN carried in the packet should be the MAC VLAN.

- The MAC VLAN function is applied only to untagged packets, but not applied to PRIORITY packets (packets whose VLAN tag is 0 and carrying COS PRIORITY information) and the processing actions are uncertain.
- The QoS packet trust model on a switch is disabled by default, which will change PRIORITY of all packets to 0 and overwrite the modification on packet priorities by the MAC VLAN function. Run the **mls qos trust cos** command in the interface configuration mode to enable the QoS trust model and trust packet priorities.

❖ Deleting All Static MAC VLAN Entries

- Optional.
- To delete all static MAC VLAN entries, you should perform this configuration.
- Perform this configuration on a switch.

Command	no mac-vlan all
Parameter Description	N/A
Command Mode	Global configuration mode
Usage Guide	N/A

❖ Deleting the Static MAC VLAN Entry of a Specified MAC Address

- Optional.
- To delete the MAC VLAN entry of a specified MAC address, you should perform this configuration.
- Perform this configuration on a switch.

Command	no mac-vlan mac-address <i>mac-address</i> [mask <i>mac-mask</i>]
Parameter Description	mac-address <i>mac-address</i> : Indicates a MAC address. mask <i>mac-mask</i> : Indicates a mask.
Command Mode	Global configuration mode
Usage Guide	N/A

❖ Deleting the Static MAC VLAN Entry of a Specified VLAN

- Optional.
- To delete the MAC VLAN entry of a specified VLAN, you should perform this configuration.
- Perform this configuration on a switch.

Command	no mac-vlan vlan <i>vlan-id</i>
Parameter	vlan <i>vlan-id</i> : Indicates a VLAN.

Description	
Command	Global configuration mode
Mode	
Usage Guide	N/A

Verification

- Run the **show mac-vlan static** command to check whether all static MAC VLAN entries are correct.
- Run the **show mac-vlan vlan *vlan-id*** command to check whether the MAC VLAN entry of a specified VLAN is correct.
- Run the **show mac-vlan mac-address *mac-address* [mask *mac-mask*]** command to display the MAC VLAN entry of a specified MAC address.

Command	show mac-vlan static show mac-vlan vlan <i>vlan-id</i> show mac-vlan mac-address <i>mac-address</i> [mask <i>mac-mask</i>]
Parameter Description	vlan <i>vlan-id</i> : Indicates a specified VLAN. mac-address <i>mac-address</i> : Indicates a specified MAC address. mask <i>mac-mask</i> : Indicates a specified mask.
Command Mode	Privileged configuration mode/Global configuration mode/Interface configuration mode
Usage Guide	N/A
Command Display	<pre>Qtech# show mac vlan all The following MAC VLAN address exist: S: Static D: Dynamic MAC ADDR MASK VLAN ID PRIO STATE 0000.0000.0001 ffff.ffff.ffff 2 0 D 0000.0000.0002 ffff.ffff.ffff 3 3 S 0000.0000.0003 ffff.ffff.ffff 3 3 S&D Total MAC VLAN address count: 3</pre>

Configuration Example

❖ Adding a Static MAC VLAN Entry Globally

As shown in Figure 6-1, PC-A1 and PC-A2 belong to department A and are assigned to VLAN 100. PC-B1 and PC-B2 belong to department B and are assigned to VLAN 200. Due to employee mobility, the company provides a temporary office at the meeting room but requires that

accessed employees be assigned to the VLANs of their own departments. For example, PC-A1 must be assigned to VLAN 100 and PC-B1 must be assigned to VLAN 200 after access.

Since the access ports for PCs at the meeting room are not fixed, the MAC VLAN function can be used to associate the PC MAC addresses with the VLANs of their departments. No matter which ports the employees use for access, the MAC VLAN function automatically assigns the VLANs of their departments.

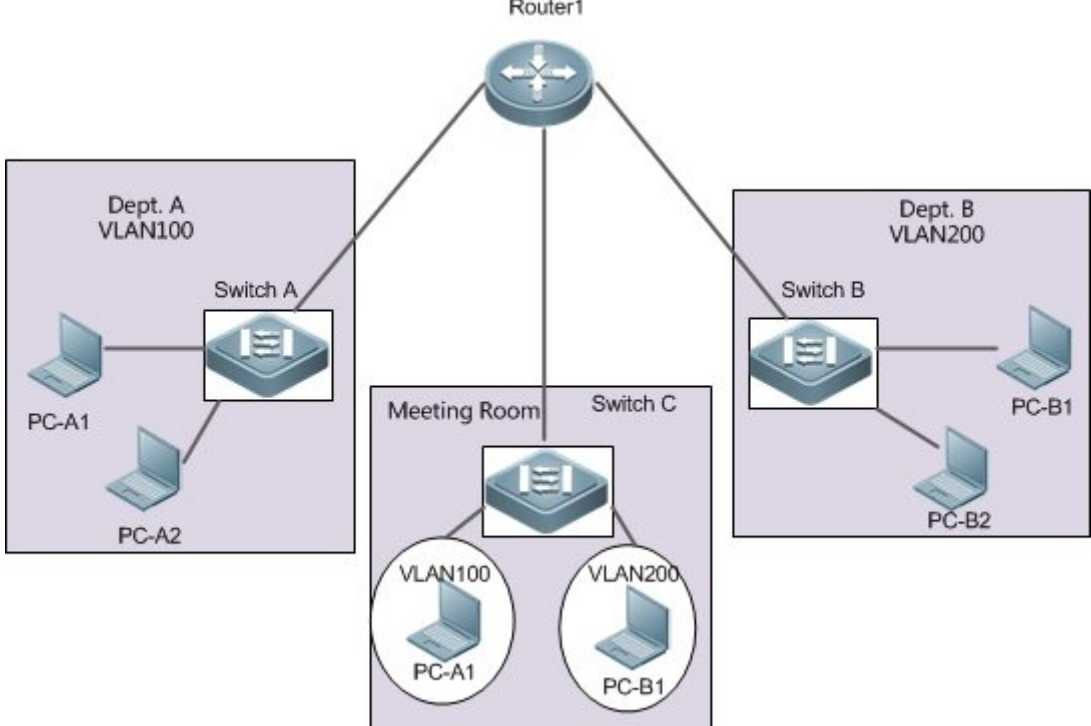
<p>Scenario Figure 6-1</p>	
<p>Configuration Steps</p>	<ul style="list-style-type: none"> ➤ Configure the port connecting Switch C and Router 1 as a Trunk port. ➤ Configure all ports connecting PCs on Switch C as hybrid ports, enable the MAC VLAN function and modify the default untagged VLAN list. ➤ Configure MAC VLAN entries on Switch C.
<p>A</p>	<pre>A# configure terminal A(config)# interface interface_name A(config if)# switchport mode trunk A(config if)# exit A(config)# interface interface_name A(config if)# switchport mode hybrid A(config if)# switchport hybrid allowed vlan add untagged 100,200 A(config if)# mac vlan enable A(config if)# exit</pre>

	<pre>A(config)# mac vlan mac address PC A1 mac vlan 100 A(config)# mac vlan mac address PC B1 mac vlan 200</pre>
Verification	Check the configured static MAC VLAN entries on Switch C.
A	<pre>A# Qtech# show mac vlan static The following MAC VLAN address exist: S: Static D: Dynamic MAC ADDR MASK VLAN ID PRIO STATE PC-A1-macffff.ffff.ffff 100 0 S PC-B1-macffff.ffff.ffff 200 3 S Total MAC VLAN address count: 2</pre>

6.5 Monitoring

Displaying

Description	Command
Displays all the MAC VLAN entries, including static and dynamic.	show mac-vlan all
Displays the dynamic MAC VLAN entries.	show mac-vlan dynamic
Displays the static MAC VLAN entries.	show mac-vlan static
Displays the MAC VLAN entries of a specified VLAN.	show mac-vlan vlan <i>vlan-id</i>
Displays the MAC VLAN entries of a specified MAC address.	show mac-vlan mac-address <i>mac-address</i> [mask <i>mac-mask</i>]

Debugging

System resources are occupied when debugging information is output. Therefore, disable debugging immediately after use.

Description	Command
Debugs the MAC VLAN function.	debug bridge mvlan

7. CONFIGURING SUPER VLAN

1.1 Overview

Super virtual local area network (VLAN) is an approach to dividing VLANs. Super VLAN is also called VLAN aggregation, and is a management technology tailored for IP address optimization.

Using super VLAN can greatly save IP addresses. Only one IP address needs to be assigned to the super VLAN that consists of multiple sub VLANs, which greatly saves IP addresses and facilitates network management.

7.1 Application

Application	Description
Sharing One IP Gateway Among Multiple VLANs	VLANs are divided to implement layer-2 (L2) isolation of access users. All VLAN users share one IP gateway to implement layer-3 (L3) communication and communication with external networks.

7.1.1 Sharing One IP Gateway Among Multiple VLANs

Scenario

Multiple VLANs are isolated at L2 on a L3 device, but users of these VLANs can perform L3 communication with each other in the same network segment.

Figure7-1

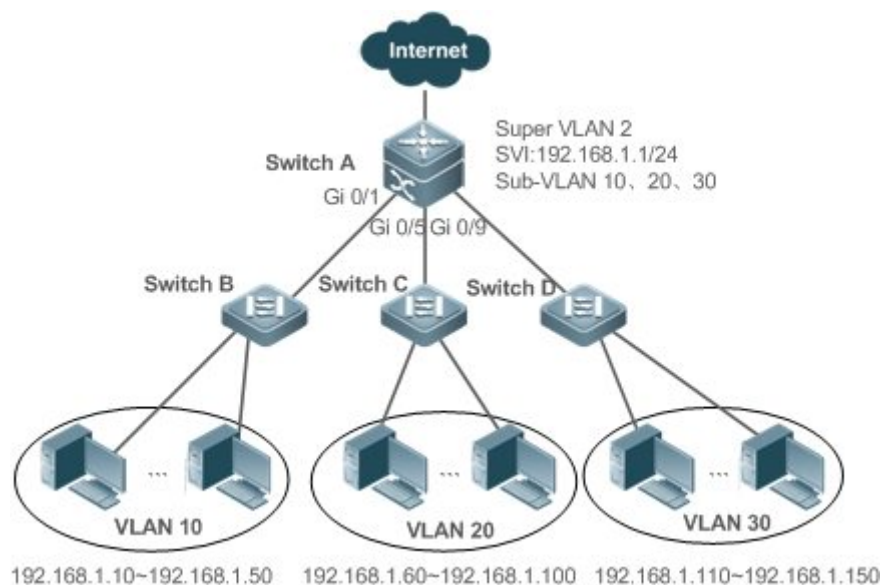

Remarks	Switch A is a gateway or core switch. Switch B, Switch C, and Switch D are access switches. On Switch A, a super VLAN and multiple sub VLANs are configured, and a L3 interface and the IP address of the L3 interface are configured for the super VLAN. VLAN 10 is configured on Switch B, VLAN 20 is configured on Switch C, and VLAN 30 is configured on Switch D. Different departments of the company reside in different VLANs.
----------------	---

Deployment

On the intranet, use the super VLAN so that multiple sub VLANs can share one IP gateway and meanwhile VLANs are mutually isolated at L2.

Users in sub VLANs can perform L3 communication through the gateway of the super VLAN.

7.2 Features

Basic Concepts

❖ Super VLAN

Super VLAN is also called VLAN aggregation, and is a management technology tailored for IP address optimization. It aggregates multiple VLANs to one IP network segment. No physical port can be added to a super VLAN. The switch virtual interface (SVI) is used to manage the cross-VLAN communication of sub VLANs. The super VLAN cannot be used as a common 802.1Q VLAN, but can be treated as the primary VLAN of sub VLANs.

❖ Sub VLAN

A sub VLAN is an independent broadcast domain. Sub VLANs are mutually isolated at L2. Users of sub VLANs of the same or different super VLANs communicate with each other through the L3 SVIs of their own super VLANs.

❖ ARP Proxy

A L3 SVI can be created only for a super VLAN. Users in a sub VLAN communicates with users in other sub VLANs of the same super VLAN or users in other network segments through the ARP proxy and the L3 SVI of the super VLAN. When a user of a sub VLAN sends an ARP request to a user of another sub VLAN, the gateway of the super VLAN uses its own MAC address to send or respond to the ARP requests. The process is called ARP proxy.

❖ IP Address Range of the Sub VLAN

Based on the gateway IP address configured for the super VLAN, an IP address range can be configured for each sub VLAN.

Overview

Feature	Description
Super VLAN	Create a L3 interface as anSVI to allow all sub VLANs to share the same IP network segment through the ARP proxy.

7.2.1 Super VLAN

Users of all sub VLANs of a super VLAN can be allocated IP addresses in the same IP address range, and share the same IP gateway. Users can implement cross-VLAN communication through this gateway. It is unnecessary to allocate a gateway for every VLAN, which saves the IP addresses.

Working Principle

IP addresses in a network segment are allocated to different sub VLANs that belong to the same super VLAN. Each sub VLAN has an independent broadcast domain of the VLAN, and different sub VLANs are isolated from each other at L2. When users in sub VLANs need to perform L3 communication, the IP address of the SVI of the super VLAN is used as the gateway address. In this way, multiple VLANs share the same IP gateway, and it is unnecessary to configure a gateway for every VLAN. In addition, to implement L3 communication between sub VLANs and between sub VLANs and other network segments, the ARP proxy function is used to forward and process the ARP requests and responses.

L2 communication of sub VLANs: If the SVI is not configured for the super VLAN, sub VLANs of super VLAN are mutually isolated at L2, that is, users in different sub VLANs cannot communicate with each other. If the SVI is configured for the super VLAN, and the gateway of the super VLAN can function as the ARP proxy, users in different sub VLANs of the same super VLAN can communicate with each other. This is because IP addresses of users in different sub VLANs belong to the same network segment, and communication between these users is still treated as L2 communication.

L3 communication of sub VLANs: If users in sub VLANs of a super VLAN need to perform L3 communication across network segments, the gateway of this super VLAN functions as the ARP proxy to respond to the ARP requests in place of sub VLANs.

7.3 Configuration

Configuration Item	Description and Command	
Configuring Basic Functions of the Super VLAN	Mandatory.	
	supervlan	Configures a super VLAN.
	subvlan <i>vlan-id-list</i>	Configures a sub VLAN.
	proxy-arp	Enables the ARP proxy function.
	interface vlan <i>vlan-id</i>	Creates a virtual interface for a super VLAN.

Configuration Item	Description and Command	
	<code>ip address ip mask</code>	Configures the IP address of the virtual interface of a super VLAN.
	➤ Optional.	
	<code>subvlan-address-range start-ip end-ip</code>	Specifies the IP address range in a sub VLAN.

7.3.1 Configuring Basic Functions of the Super VLAN

Configuration Effect

Enable the super VLAN function and configure an SVI for the super VLAN to implement L2/L3 communication between sub VLANs across VLANs.

Users in all sub VLANs of a super VLAN share the same IP gateway. It is unnecessary to specify a network segment for every VLAN, which saves the IP addresses.

Notes

A super VLAN does not belong to any physical port. Therefore, the device configured with the super VLAN cannot process packets that contain the super VLAN tag.

Both the super VLAN function and the ARP proxy function of each sub VLAN must be enabled.

An SVI and an IP address must be configured for a super VLAN. The SVI is a virtual interface used for communication of users in all sub VLANs.

Configuration Steps

❖ Configuring a Super VLAN

- Mandatory.
- No physical port exists in a super VLAN.
- The ARP proxy function must be enabled. This function is enabled by default.
- You can run the **supervlan** command to change a common VLAN into a super VLAN.
- After a common VLAN becomes a super VLAN, ports added to this VLAN will be deleted from this VLAN because no physical port exists in a super VLAN.

➤ A super VLAN is valid only after you configure sub VLANs for this super VLAN.

VLAN 1 cannot be configured as a super VLAN.

A super VLAN cannot be configured as a sub VLAN of another super VLAN. A sub VLAN of a super VLAN cannot be configured as a super VLAN.

Command	supervlan
Parameter Description	N/A
Defaults	By default, a VLAN is a common VLAN.
Command Mode	VLAN configuration mode
Usage Guide	By default, the super VLAN function is disabled. No physical port can be added to a super VLAN. Once a VLAN is not a super VLAN, all its sub VLANs become common static VLANs.

❖ Configuring a Virtual Interface for a Super VLAN

- Mandatory.
- No physical port can be added to a super VLAN. You can configure the L3 SVI for a VLAN. The IP gateway on the L3 SVI is configured as the proxy for all users in sub VLANs to respond to ARP requests.

When a super VLAN is configured with an SVI, it allocates a L3 interface to each sub VLAN. If a sub VLAN is not allocated a L3 interface due to resource deficiency, the sub VLAN becomes a common VLAN again.

Command	interface vlan <i>vlan-id</i>
Parameter Description	<i>vlan-id</i> : Indicates the ID of the super VLAN.
Defaults	By default, no super VLAN is configured.
Command Mode	Global configuration mode
Usage Guide	A L3 interface must be configured as the virtual interface of a super VLAN.

❖ Configuring the Gateway of a Super VLAN

- Mandatory.
- The IP gateway on the L3 SVI is configured as the proxy for all users in sub VLANs to respond to ARP requests.

Command	ip address <i>ip mask</i>
Parameter Description	<i>ip</i> : Indicates the IP address of the gateway on the virtual interface of a super VLAN. <i>Mask</i> : Indicates the mask.
Defaults	By default, no gateway is configured for a super VLAN.

Command Mode	Interface configuration mode
Usage Guide	Run this command to configure the gateway for a super VLAN. Users of all sub VLANs of the super VLAN share this gateway.

❖ Configuring a Sub VLAN

- Mandatory.
- Physical ports can be added to sub VLANs. Sub VLANs of a super VLAN share the gateway address of the super VLAN and reside in the same network segment.
- The ARP proxy function must be enabled. This function is enabled by default.
- You can run the **subvlanvlan-id-list** command to change a common VLAN into a sub VLAN of a super VLAN. Physical ports can be added to sub VLANs.
- Communication of users in a sub VLAN is managed by the super VLAN.

You must change a sub VLAN into a common VLAN before you can delete this sub VLAN by running the **no vlan** command.

One sub VLAN belongs to only one super VLAN.

Command	subvlanvlan-id-list
Parameter Description	<i>vlan-id-list</i> : Specifies multiple VLANs as sub VLANs of a super VLAN.
Defaults	By default, a VLAN is a common VLAN.
Command Mode	VLAN configuration mode
Usage Guide	<p>Connection interfaces can be added to a sub VLAN.</p> <p>You must change a sub VLAN into a common VLAN before you can delete this sub VLAN by running the no vlan [id] command.</p> <p>You cannot configure a L3 SVI of the VLAN for a sub VLAN.</p> <hr/> <p>➤ If you have configured a L3 SVI for a super VLAN, the attempt of adding more sub VLANs may fail due to resource deficiency.</p> <p>If you configure sub VLANs to a super VLAN, and then configure a L3 SVI of the VLAN for a super VLAN, some sub VLANs may become common VLANs again due to resource deficiency.</p>

❖ Configuring the ARP Proxy

- (Mandatory) The ARP proxy function is enabled by default.
- Users in sub VLANs can implement L2/L3 communication across VLANs through the gateway proxy only after the ARP proxy function is enabled on both the super VLAN and sub VLANs.

- Users in sub VLANs can communicate with users of other VLANs only after the ARP proxy function is enabled on both the super VLAN and sub VLANs.

The ARP proxy function must be enabled on both the super VLAN and sub VLANs. Otherwise, this function does not take effect.

Command	<code>proxy-arp</code>
Parameter Description	N/A
Defaults	By default, the ARP proxy function is enabled.
Command Mode	VLAN configuration mode
Usage Guide	By default, the ARP proxy function is enabled. Run this command to enable the ARP proxy function on both the super VLAN and sub VLANs. Users in sub VLANs can implement L2/L3 communication across VLANs only after the ARP proxy function is enabled on both the super VLAN and sub VLANs.

❖ Configuring the IP Address Range of the Sub VLAN

- You can allocate an IP address range to each sub VLAN. Users in a sub VLAN can communicate with users of other VLANs only when their IP addresses are in the specified range.
- Unless otherwise specified, you do not need to configure the IP address range.

IP addresses dynamically allocated to users through DHCP may not be in the allocated IP address range. If the IP addresses allocated through DHCP are not in the specified range, users in a sub VLAN cannot communicate with users of other VLANs. Therefore, be cautious in using the `subvlan-address-range start-ip end-ip` command.

The IP address range of a sub VLAN must be within the IP address range of the super VLAN to which the sub VLAN belongs. Otherwise, users in sub VLANs cannot communicate with each other.

IP addresses of users in a sub VLAN must be within the IP address range of the sub VLAN. Otherwise, users in the sub VLAN cannot communicate with each other.

Command	<code>subvlan-address-range start-ip end-ip</code>
Parameter Description	<i>start-ip</i> : Indicates the start IP address of a sub VLAN. <i>end-ip</i> : Indicates the end IP address of a sub VLAN.
Defaults	By default, no IP address range is configured.
Command Mode	VLAN configuration mode
Usage Guide	Optional. Run this command to configure the IP address range of users in a sub VLAN. IP address ranges of different sub VLANs of a super VLAN cannot overlap with each other. The IP address range of a sub VLAN must be within the IP address range of the super VLAN to which the sub VLAN belongs. Otherwise, users in sub VLANs cannot

communicate with each other.

Users in a sub VLAN can communicate with users of other VLANs only when their IP addresses (either dynamically allocated through DHCP or statically configured) are in the configured IP address range.

IP addresses allocated through DHCP may not be in the configured IP address range. In this case, users in a sub VLAN cannot communicate with users of other VLANs. Therefore, be cautious when using this command.

Verification

After each sub VLAN is correlated with the gateway of the super VLAN, users in sub VLANs can ping each other.

Configuration Example

- ❖ Configuring a Super VLAN on the Network so That Users in its Sub VLANs Use the Same Network Segment and Share the Same IP Gateway to Save IP Addresses

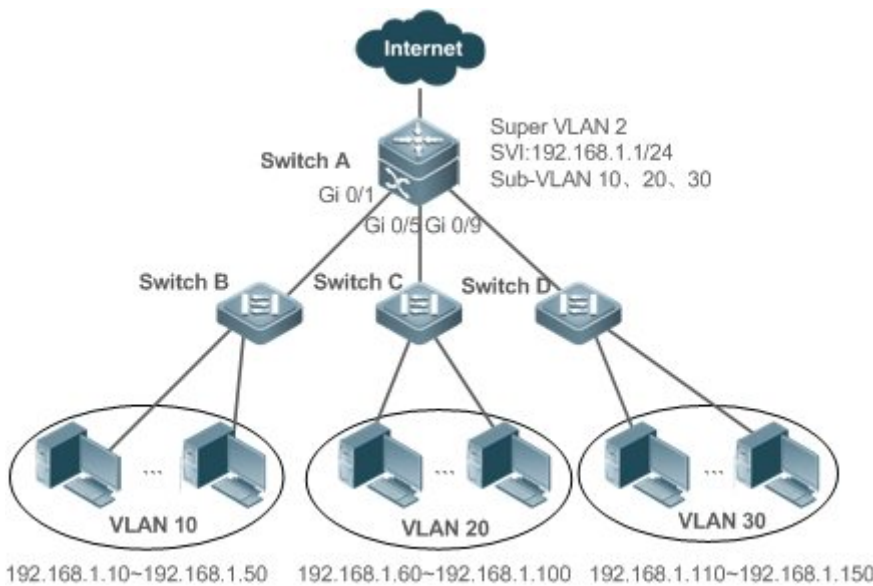
<p>Scenario Figure 7-2</p>	
<p>Configuration Steps</p>	<p>Perform the related super VLAN configuration on the core switch. On the access switches, configure the common VLANs corresponding to the sub VLANs on the core switch.</p>
<p>A</p>	<pre>SwitchA#configure terminal Enter configuration commands, one per line. End with CNTL/Z. SwitchA(config)#vlan 2 SwitchA(config-vlan)#exit</pre>

```

SwitchA(config)#vlan 10
SwitchA(config-vlan)#exit
SwitchA(config)#vlan 20
SwitchA(config-vlan)#exit
SwitchA(config)#vlan 30
SwitchA(config-vlan)#exit
SwitchA(config)#vlan 2
SwitchA(config-vlan)#supervlan
SwitchA(config-vlan)#subvlan 10, 20, 30
SwitchA(config-vlan)#exit
SwitchA(config)#interface vlan 2
SwitchA(config-if-VLAN 2)#ip address 192.168.1.1 255.255.255.0
SwitchA(config)#vlan 10
SwitchA(config-vlan)#subvlan-address-range 192.168.1.10 192.168.1.50
SwitchA(config-vlan)#exit
SwitchA(config)#vlan 20
SwitchA(config-vlan)#subvlan-address-range 192.168.1.60 192.168.1.100
SwitchA(config-vlan)#exit
SwitchA(config)#vlan 30
SwitchA(config-vlan)#subvlan-address-range 192.168.1.110 192.168.1.150
SwitchA(config)#interface range gigabitEthernet 0/1,0/5,0/9
SwitchA(config-if-range)#switchport mode trunk

```

Verification

Verify that the source host (192.168.1.10) and the destination host (192.168.1.60) can ping each other.

A

```

SwitchA(config-if-range)#show supervlan
supervlan id  supervlan arp-proxy  subvlan id  subvlan arp-proxy
subvlan ip range
-----
-----
          2          ON          10          ON192.168.1.10 - 192.168.1.50
20          ON 192.168.1.60 - 192.168.1.100

```



```
30 ON 192.168.1.110 - 192.168.1.150
```

Common Errors

The SVI and IP gateway are not configured for the super VLAN. Consequently, communication fails between sub VLANs and between sub VLANs and other VLANs.

The ARP proxy function is disabled on the super VLAN or sub VLANs. Consequently, users in sub VLANs cannot communicate with users of other VLANs.

The IP address range of the sub VLAN is configured, but IP addresses allocated to users are not in this range.

7.4 Monitoring

Displaying

Description	Command
Displays the super VLAN configuration.	show supervlan

Debugging

System resources are occupied when debugging information is output. Therefore, disable debugging immediately after use.

Description	Command
Debugs the super VLAN.	debug bridge svlan

8. CONFIGURING PROTOCOL VLAN

8.1 Overview

The protocol VLAN technology is a VLAN distribution technology based on the packet protocol type. It can distribute packets of a certain protocol type with a null VLAN ID to the same VLAN. That is, the switch, based on the protocol type and encapsulation format of packets received by ports, matches the received untagged packets with protocol profiles. If the matching is successful, the switch automatically distributes the packets to a relevant VLAN for transmission. There are two types of protocol VLANs: IP address-based protocol VLAN and protocol VLAN based on the packet type and Ethernet type on ports. The protocol VLAN based on the packet type and Ethernet type on ports is called protocol VLAN for short and the IP address-based protocol VLAN is called subnet VLAN for short.

➤ The protocol VLAN is applicable only to Trunk ports and Hybrid ports.

Protocols and Standards

IEEE standard 802.1Q

8.2 Applications

Application	Description
Configuration and Application of Protocol VLAN	Implements Layer-2 communication isolation of user hosts that use different protocol packets for communication to reduce the network traffic.
Configuration and Application of Subnet VLAN	Specifies the VLAN range based on the IP network segment to which user packets belong.

8.2.1 Configuration and Application of Protocol VLAN

Scenario

As shown in the following figure, the network architecture is composed of the interconnected Windows NT server and Novell Netware server and the office area is connected to the Layer-3 device Switch A through a hub. There are different PCs in the office area. Some PCs use the Windows NT operating system (OS) and support the IP protocol, and some PCs use the Novell Netware OS and support the IPX protocol. PCs in the office area communicate with the external network and servers through the uplink port Gi 0/3.

The main requirements are as follows:

- The Layer-2 communication of PCs using the Windows NT OS is isolated from that of PCs using the Novell Netware OS, so as

to reduce the network traffic.

Figure 8-1

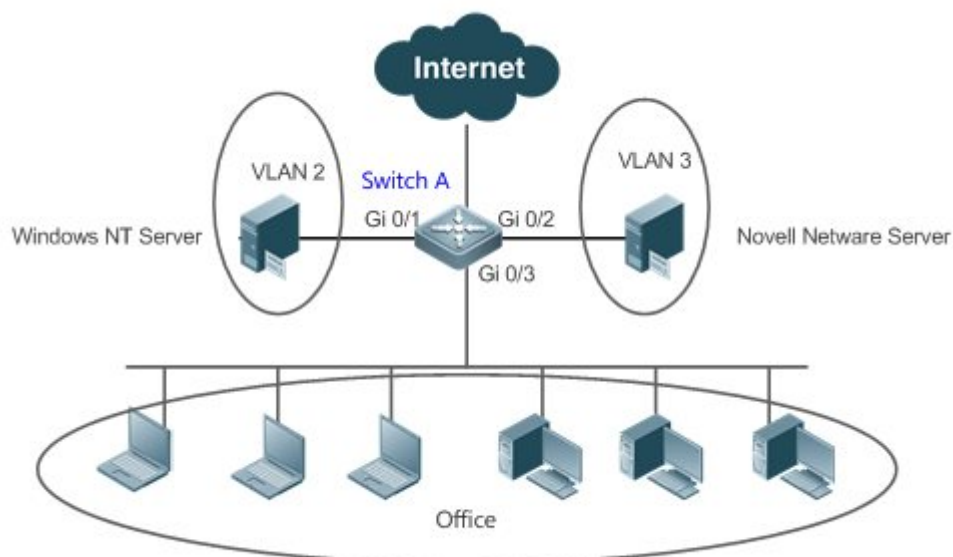

Remark	Switch A is a switch and Port Gi 0/3 is a Hybrid port. Port Gi 0/1 is an Access port and belongs to VLAN 2.
s	Port Gi 0/2 is also an Access port and belongs to VLAN 3.

Deployment

- Configure profiles of the packet type and Ethernet type (in this example, configure Profile 1 for IP protocol packets and configure Profile 2 for IPX protocol packets).
- Apply the profiles to the uplink port (Port Gi 0/3 in this example) and associate them with VLANs (in this example, associate Profile 1 with VLAN 2 and associate Profile 2 with VLAN 3).

The configured protocol VLANs take effect only on the Trunk ports and Hybrid ports.

8.2.2 Configuration and Application of Subnet VLAN

Scenario

As shown in the following figure, PCs in Office A and Office B are connected to the Layer-3 device Switch A through hubs. In Office A, the PCs belong to a fixed network segment and they are distributed to the same VLAN by port. In Office B, the PCs belong to two network segments, but they cannot be distributed to VLANs by fixed port.

The main requirements are as follows:

For PCs in Office B, Switch A can determine the VLAN range of the PCs based on the IP network segment to which their packets belong.

Figure 8-2

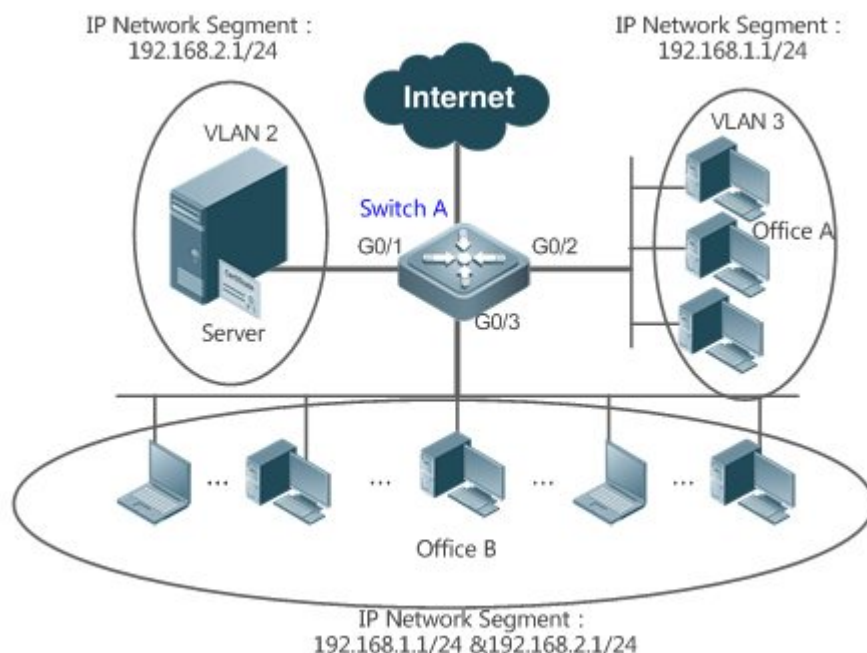

Remark	Switch A is a switch. Port G0/1 is an Access port and belongs to VLAN 2. Port G0/2 is also an Access port and belongs to VLAN 3. Port G0/3 is a Hybrid port.
---------------	--

Deployment

- Globally configure subnet VLANs (in this example, allocate the IP network segment 192.168.1.1/24 to VLAN 3 and the IP network segment 192.168.2.1/24 to VLAN 2) and enable the subnet VLAN function on the uplink port (Port Gi 0/3 in this example).

The configured subnet VLANs take effect only on the Trunk ports and Hybrid ports.

8.3 Features

Basic Concepts

❖ Protocol VLAN

The protocol VLAN technology is a VLAN distribution technology based on the packet protocol type. It can distribute packets of a certain protocol type with a null VLAN ID to the same VLAN.

VLANs need to be specified for packets received by device ports so that a packet belongs to a unique VLAN. There are three possible cases:

- If a packet contains a null VLAN ID (untagged or priority packet) and the device supports only port-based VLAN distribution, the VLAN ID in the tag added to the packet is the PVID of the input port.
- If a packet contains a null VLAN ID (untagged or priority packet) and the device supports VLAN distribution based on the packet protocol type, the VLAN ID in the tag added to the packet is selected from the VLAN IDs mapped to the protocol suite configuration of the input port. If the protocol type of the packet does not match all protocol suite configuration of the input port, a VLAN ID is allocated according to the port-based VLAN distribution.
- If a packet is a tagged packet, the VLAN to which the packet belongs is determined by the VLAN ID in the tag.

Subnet VLANs can be configured only globally that is, only the protocol VLAN function can be enabled or disabled on ports. The matching configuration is globally performed for the protocol VLAN, the matching configuration is selected on ports and the VLAN IDs are specified for packets that are matched successfully.

- If an input packet contains a null VLAN ID and the IP address of the input packet matches an IP address, the packet is distributed to the subnet VLAN.
- If an input packet contains a null VLAN ID and the packet type and Ethernet type of the input packet match the packet type and Ethernet type of an input port, the packet is allocated to the protocol VLAN.

❖ Protocol VLAN Priority

The priority of a subnet VLAN is higher than that of a protocol VLAN. That is, if a subnet VLAN and protocol VLAN are configured at the same time and an input packet conforms to both the subnet VLAN and protocol VLAN, the subnet VLAN prevails.

Overview

Feature	Description
Automatic VLAN Distribution Based on Packet Type	The service types supported on a network are bound with VLANs or packets from a specified IP network segment are transmitted in a specified VLAN to facilitate management and maintenance.

8.3.1 Automatic VLAN Distribution Based on Packet Type

Working Principle

Set rules on the hardware and enable the rules on ports. The rules take effect only after they are enabled on ports. The rules include the packet type and IP address of packets. When a port

receives untagged data packets that meet the rules, the port automatically distributes them to the VLAN specified in the rules for transmission. When the rules are disabled on ports, untagged data packets are distributed to the Native VLAN according to the port configuration.

Related Configuration

8.4 Configuration

Configuration	Description and Command
Configuring the Protocol VLAN Function	<p>(Mandatory) It is used to enable the VLAN distribution function based on the packet type and Ethernet type of the protocol VLAN.</p>
	<p>protocol-vlan profile num frame-type [type] ether-type [type]</p> <p>Configures the profile of the packet type and Ethernet type.</p>
	<p>protocol-vlan profile num ether-type [type]</p> <p>Configures the profile of the Ethernet type (some models do not support frame identification).</p>
	<p>protocol-vlan profile num vlan vid</p> <p>(Interface configuration mode) Applies the protocol VLAN on a port.</p>
Configuring the Subnet VLAN Function	<p>(Mandatory) It is used to enable IP address-based VLAN distribution function of the protocol VLAN.</p>
	<p>protocol-vlan ipv4 address mask address vlan vid</p> <p>Configures an IP address, subnet mask, and VLAN distribution.</p>
	<p>protocol-vlan ipv4</p> <p>(Interface configuration mode) Enables the subnet VLAN on a port.</p>

8.4.1 Configuring the Protocol VLAN Function

Configuration Effect

Bind service types supported in a network with VLANs to facilitate management and maintenance.

Notes

- It is recommended that the protocol VLAN be configured after VLANs, and the Trunk, Hybrid, Access, and AP attributes of ports are configured.

- If protocol VLAN is configured on a Trunk port or Hybrid port, all VLANs relevant to the protocol VLAN need to be contained in the permitted VLAN list of the Trunk port or Hybrid port.

Configuration Steps

❖ Configuring the Protocol VLAN Globally

- Mandatory.
- The protocol VLAN can be applied on an interface only in global configuration mode.

Command	<code>protocol-vlan profile num frame-type [type] ether-type [type]</code>
Parameter	<i>num</i> : Indicates the profile index.
Description	<i>type</i> : Indicates the packet type and Ethernet type.
Defaults	The protocol VLAN is disabled by default.
Command Mode	Global configuration mode
Usage Guide	The protocol VLAN can be configured on an interface only when the protocol VLAN is globally configured. When the global configuration of a protocol VLAN profile is deleted, the protocol VLAN configuration is deleted from all interfaces corresponding to the profile of the protocol VLAN.

❖ Switching the Port Mode to Trunk/Hybrid Mode

- Mandatory. The protocol VLAN function takes effect only on ports that are in Trunk/Hybrid mode.

❖ Enabling the Protocol VLAN on a Port

- Mandatory. The protocol VLAN is disabled by default.
- The protocol VLAN is truly enabled only when it is applied on interfaces.

Command	<code>protocol-vlan profile num vlan vid</code>
Parameter	<i>num</i> : Indicates the profile index.
Description	<i>vid</i> : Indicates the VLAN ID. The value 1 indicates the maximum VLAN ID supported by the product.
Defaults	The protocol VLAN is disabled by default.
Command Mode	Interface configuration mode
Usage Guide	An interface must work in Trunk/Hybrid mode.

Verification

Run the **show protocol-vlan profile** command to check the configuration.

Configuration Example

❖ Enabling the Protocol VLAN Function in the Topological Environment

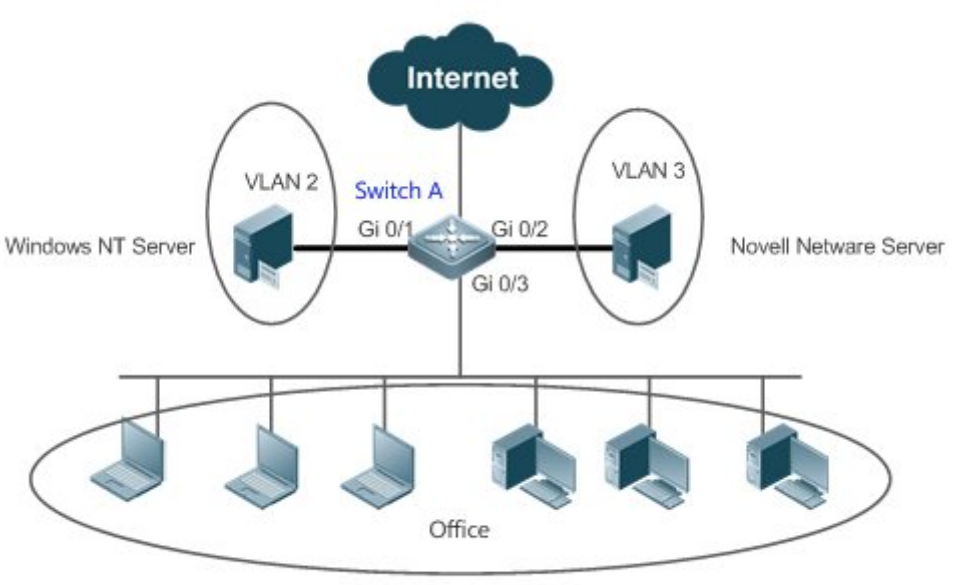
<p>Scenario</p> <p>Figure 8-3</p>	 <p>The diagram illustrates a network topology. At the top, a cloud labeled 'Internet' is connected to 'Switch A'. Switch A has three uplink ports: Gi 0/1 connected to a server in 'VLAN 2' (labeled 'Windows NT Server'), Gi 0/2 connected to a server in 'VLAN 3' (labeled 'Novell Network Server'), and Gi 0/3 connected to a central bus. This bus is connected to an 'Office' network containing several laptops and desktop computers.</p>
<p>Configuration Steps</p>	<ul style="list-style-type: none"> ➤ Configure VLAN 2 and VLAN 3 for user communication on Switch A. ➤ Configure the protocol VLAN globally on Switch A (in this example, configure Profile 1 for IP protocol packets and configure Profile 2 for IPX protocol packets), enable the protocol VLAN function on the uplink port (Port Gi 0/3 in this example), and complete the protocol-VLAN association (in this example, associate Profile 1 with VLAN 2 and associate Profile 2 with VLAN 3). ➤ Port Gi 0/1 is an Access port and belongs to VLAN 2. Port Gi 0/2 is also an Access port and belongs to VLAN 3. Port Gi 0/3 is a Hybrid port. Ensure that the user communication VLANs are contained in the permitted untagged VLAN list of the Hybrid port.
<p>A</p>	<pre>1. Create VLAN 2 and VLAN 3 for user network communication. # configure terminal Enter configuration commands, one per line. End with CNTL/Z. A(config)# vlan range 2 3</pre>

	<p>2. Configure the port mode.</p> <pre>A(config)#interface gigabitEthernet 0/1 A(config if GigabitEthernet 0/1)#switchport A(config if GigabitEthernet 0/1)#switchport access vlan 2 A(config if GigabitEthernet 0/1)#exit A(config)#interface gigabitEthernet 0/2 A(config if GigabitEthernet 0/2)#switchport A(config if GigabitEthernet 0/2)#switchport access vlan 3 A(config if GigabitEthernet 0/2)#exit A(config)# interface gigabitEthernet 0/3 A(config if GigabitEthernet 0/3)#switchport A(config if GigabitEthernet 0/3)# switchport mode hybrid A(config if GigabitEthernet 0/3)# switchport hybrid allowed vlan untagged 2 3</pre> <p>3. Configure the protocol VLAN globally.</p> <p>Configure Profile 1 for IP protocol packets and Profile 2 for IPX protocol packets (in this example, assume that packets are encapsulated using Ethernet II and the Ethernet types of IP protocol packets and IPX protocol packets are 0X0800 and 0X8137 respectively).</p> <pre>A(config)#protocol vlan profile 1 frame type ETHERII ether type 0x0800 A(config)#protocol vlan profile 2 frame type ETHERIIether type 0x8137</pre> <p>4. Apply Profile 1 and Profile 2 to Port Gi 0/3 and allocate Profile 1 to VLAN 2 and Profile 2 to VLAN 3.</p> <pre>A(config)# interface gigabitEthernet 0/3 A(config if GigabitEthernet 0/3) #protocol vlan profile 1 vlan 2 A(config if GigabitEthernet 0/3) #protocol vlan profile 2 vlan 3</pre>										
Verification	Check whether the protocol VLAN configuration on the device is correct.										
A	<pre>A(config)#show protocol vlan profile</pre> <table border="1"> <thead> <tr> <th>profile</th> <th>frame type</th> <th>ether type/DSAP+SSAP</th> <th>interface</th> <th>vlan</th> </tr> </thead> <tbody> <tr> <td></td> <td></td> <td></td> <td></td> <td></td> </tr> </tbody> </table>	profile	frame type	ether type/DSAP+SSAP	interface	vlan					
profile	frame type	ether type/DSAP+SSAP	interface	vlan							

1	ETHERII	0x0800	Gi0/3	2
2	ETHERII	0x8137	Gi0/3	3

Common Errors

- A port connected to the device is not in Trunk/Hybrid mode.
- The permitted VLAN list of the port connected to the device does not contain the user communication VLANs.
- The protocol VLAN function is disabled on a port.

8.4.2 Configuring the Subnet VLAN Function

Configuration Effect

Distribute packets from a specified network segment or IP address to a specified VLAN for transmission.

Notes

- It is recommended that the protocol VLAN be configured after VLANs, and the Trunk, Hybrid, Access, and AP attributes of ports are configured.
- If protocol VLAN is configured on a Trunk port or Hybrid port, all VLANs relevant to the protocol VLAN need to be contained in the permitted VLAN list of the Trunk port or Hybrid port.

Configuration Steps

- ❖ Configuring the Subnet VLAN Globally
 - Mandatory.
 - The subnet VLAN can be applied on an interface only in global configuration mode.

Command	<code>protocol-vlan ipv4 address mask address vlan vid</code>
Parameter	<i>address</i> : Indicates the IP address.
Description	<i>vid</i> : Indicates the VLAN ID. The value 1 indicates the maximum VLAN ID supported by the product.
Defaults	The subnet VLAN is disabled by default.

Command Mode	Global configuration mode
Usage Guide	The subnet VLAN can be enabled on an interface even if the protocol VLAN is not enabled globally. Nevertheless, the subnet VLAN takes effect only when the protocol VLAN is configured globally.

❖ Switching the Port Mode to Trunk/Hybrid Mode

- Mandatory. The subnet VLAN function takes effect only on ports that are in Trunk/Hybrid mode.

❖ Enabling the Subnet VLAN on a Port

- Mandatory. The subnet VLAN is disabled by default.
- The subnet VLAN is truly enabled only when it is applied on interfaces.

Command	<code>protocol-vlan ipv4</code>
Parameter Description	N/A
Defaults	The subnet VLAN is disabled by default.
Command Mode	Interface configuration mode
Usage Guide	An interface must work in Trunk/Hybrid mode.

[Verification](#)

Run the **show protocol-vlan ipv4** command to check the configuration.

[Configuration Example](#)

❖ Enabling the Subnet VLAN Function in the Topological Environment

Scenario Figure 8-4	
-------------------------------	--

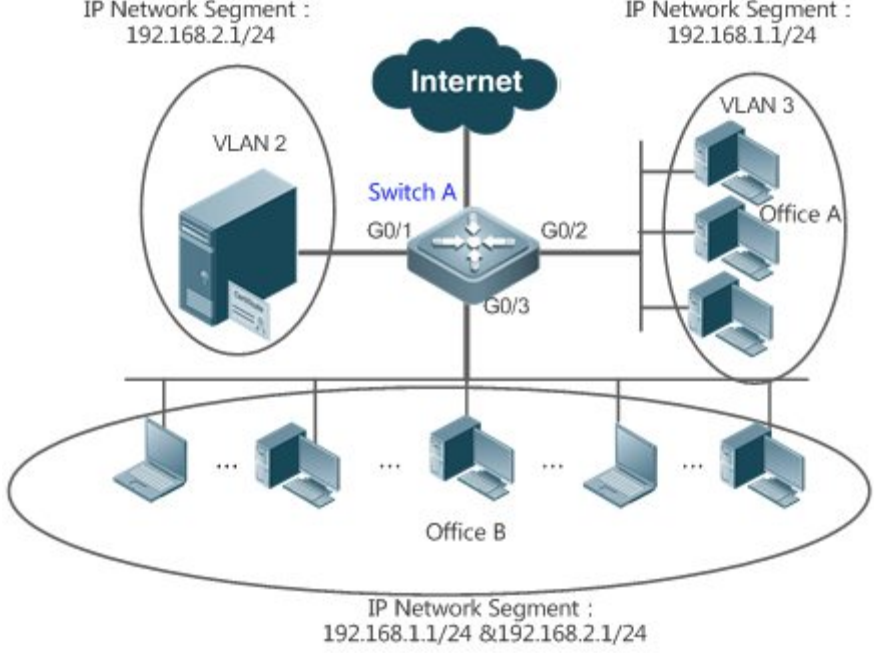
	
<p>Configuration Steps</p>	<ul style="list-style-type: none">➤ Configure VLAN 2 and VLAN 3 for user communication on Switch A.➤ Globally configure subnet VLANs on Switch A (in this example, allocate the IP network segment 192.168.1.1/24 to VLAN 3 and the IP network segment 192.168.2.1/24 to VLAN 2) and enable the subnet VLAN function on the uplink port (Port Gi 0/3 in this example).➤ Port Gi 0/1 is an Access port and belongs to VLAN 2. Port Gi 0/2 is also an Access port and belongs to VLAN 3. Port Gi 0/3 is a Hybrid port. Ensure that the user communication VLANs are contained in the permitted untagged VLAN list of the Hybrid port.
<p>A</p>	<ol style="list-style-type: none">1. Create VLAN 2 and VLAN 3 for user network communication. A# configure terminal Enter configuration commands, one per line. End with CNTL/Z. A(config)# vlan range 2 32. Configure the port mode. A(config)#interface gigabitEthernet 0/1 A(config if GigabitEthernet 0/1)#switchport A(config if GigabitEthernet 0/1)#switchport access vlan 2 A(config if GigabitEthernet 0/1)#exit

	<pre>A(config)#interface gigabitEthernet 0/2 A(config if GigabitEthernet 0/2)#switchport A(config if GigabitEthernet 0/2)#switchport access vlan 3 A(config if GigabitEthernet 0/2)#exit A(config)# interface gigabitEthernet 0/3 A(config if GigabitEthernet 0/3)#switchport A(config if GigabitEthernet 0/3)# switchport mode hybrid A(config if GigabitEthernet 0/3)# switchport hybrid allowed vlan untagged 2 3 3. Configure the subnet VLAN globally. A(config)# protocol vlan ipv4 192.168.1.0 mask 255.255.255.0 vlan 3 A(config)# protocol vlan ipv4 192.168.2.0 mask 255.255.255.0 vlan 2 4. Enable the subnet VLAN on interfaces. The subnet VLAN is disabled by default. (config if GigabitEthernet 0/1)# protocol vlan ipv4</pre>
Verification	Check whether the subnet VLAN configuration on the device is correct.
A	<pre>A# show protocol vlan ipv4 ip mask vlan 192.168.1.0 255.255.255.0 3 192.168.2.0 255.255.255.0 2 interface ipv4 status Gi0/3 enable</pre>

Common Errors

- A port connected to the device is not in Trunk/Hybrid mode.
- The permitted VLAN list of the port connected to the device does not contain the user communication VLANs.

- The subnet VLAN is disabled on a port.

8.5 Monitoring

Displaying

Description	Command
Displays the protocol VLAN content.	show protocol-vlan

Debugging

System resources are occupied when debugging information is output. Therefore, disable debugging immediately after use.

Description	Command
Debugs the protocol VLAN.	debug bridge protvlan



9. CONFIGURING PRIVATE VLAN

9.1 Overview

Private VLAN divides the Layer-2 broadcast domain of a VLAN into multiple subdomains. Each subdomain is composed of one private VLAN pair: primary VLAN and secondary VLAN.

One private VLAN domain may consist of multiple private VLAN pairs and each private VLAN pair represents one subdomain. In a private VLAN domain, all private VLAN pairs share the same primary VLAN. The secondary VLAN IDs of subdomains are different.

If a service provider allocates one VLAN to each user, the number of users that can be supported by the service provider is restricted because one device supports a maximum of 4,096 VLANs. On a Layer-3 device, one subnet address or a series of addresses are allocated to each VLAN, which results in the waste of IP addresses. The private VLAN technology properly solves the preceding two problems. Private VLAN is hereinafter called PVLAN for short.

9.2 Applications

Application	Description
Cross-Device Layer-2 Application of PVLAN	Users of an enterprise can communicate with each other but the user communication between enterprises is isolated.
Layer-3 Application of PVLAN on a Single Device	All enterprise users share the same gateway address and can communicate with the external network.

9.2.1 Cross-Device Layer-2 Application of PVLAN

Scenario

As shown in the following figure, in the hosting service operation network, enterprise user hosts are connected to the network through Switch A or Switch B. The main requirements are as follows:

- Users of an enterprise can communicate with each other but the user communication between enterprises is isolated.
- All enterprise users share the same gateway address and can communicate with the external network.

Figure 9-1

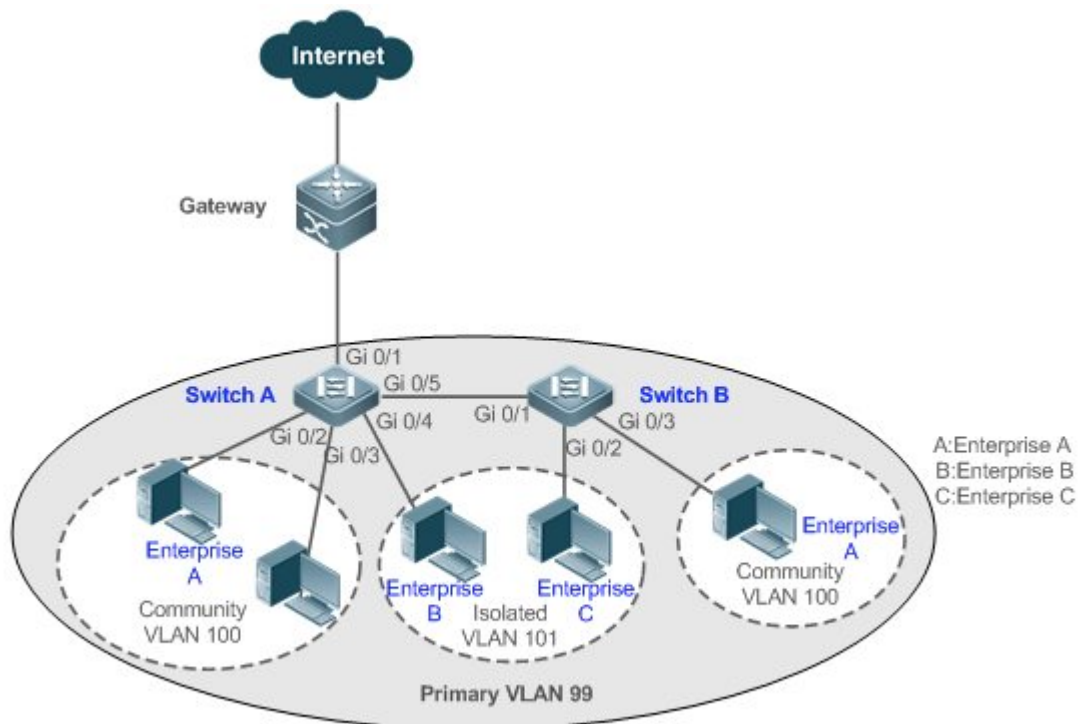

Remarks	<p>Switch A and Switch B are access switches.</p> <p>PVLAN runs across devices. The ports for connecting the devices need to be configured as Trunk ports, that is, Port Gi 0/5 of Switch A and Port Gi 0/1 of Switch B are configured as Trunk ports.</p> <p>Port Gi 0/1 for connecting Switch A to the gateway needs to be configured as a promiscuous port.</p> <p>Port Gi 0/1 of the gateway can be configured as a Trunk port or Hybrid port and the Native VLAN is the primary VLAN of PVLAN.</p>
----------------	---

Deployment

- Configure all enterprises to be in the same PVLAN (primary VLAN 99 in this example). All enterprise users share the same Layer-3 interface through this VLAN to communicate with the external network.
- If an enterprise has multiple user hosts, allocate the user hosts of different enterprises to different community VLANs. That is, configure the ports connected to the enterprise user hosts as the host ports of a community VLAN, so as to implement user communication inside an enterprise but isolate the user communication between enterprises.
- If an enterprise has only one user host, configure the ports connected to the user hosts of such enterprises as the host ports of an isolated VLAN so as to implement isolation of user communication between the enterprises.

9.2.2 Layer-3 Application of PVLAN on a Single Device

As shown in the following figure, in the hosting service operation network, enterprise user hosts are connected to the network through the Layer-3 device Switch A. The main requirements are as follows:

- Users of an enterprise can communicate with each other but the user communication between enterprises is isolated.
- All enterprise users can access the server.
- All enterprise users share the same gateway address and can communicate with the external network.

Figure 9-2

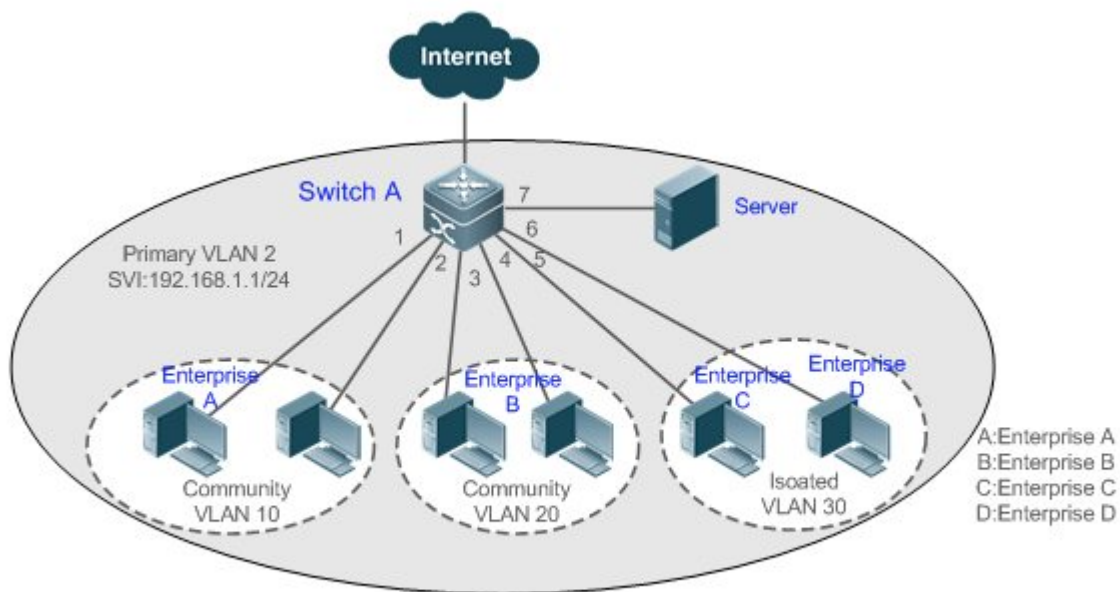

Remarks	<p>Switch A is a gateway switch.</p> <p>When user hosts are connected to a single device, Port Gi 0/7 for connecting to the server is configured as a promiscuous port so that enterprise users can communicate with the server.</p> <p>Layer-3 mapping needs to be performed on the primary VLAN and secondary VLANs so that the users can communicate with the external network.</p>
----------------	--

Deployment

t

- Configure the port that is directly connected to the server as a promiscuous port. Then, all enterprise users can communicate with the server through the promiscuous port.

- Configure the gateway address of PVLAN on the Layer-3 device (Switch A in this example) (in this example, set the SVI address of VLAN 2 to 192.168.1.1/24) and configure the mapping between the primary VLAN and secondary VLANs on the Layer-3 interface. Then, all enterprise users can communicate with the external network through the gateway address.

9.3 Features

Basic Concepts

❖ PVLAN

PVLAN supports three types of VLANs: primary VLANs, isolated VLANs, and community VLANs.

A PVLAN domain has only one primary VLAN. Secondary VLANs implement Layer-2 isolation in the same PVLAN domain. There are two types of secondary VLANs.

❖ Isolated VLAN

Ports in the same isolated VLAN cannot mutually make Layer-2 communication. A PVLAN domain has only one isolated VLAN.

❖ Community VLAN

Ports in the same community VLAN can make Layer-2 communication with each other but cannot make Layer-2 communication with ports in other community VLANs. A PVLAN domain can have multiple community VLANs.

❖ Layer-2 Association of PVLAN

PVLAN pairs exist only after Layer-2 association is performed among the three types of VLANs of PVLAN. Then, a primary VLAN has a specified secondary VLAN and a secondary VLAN has a specified primary VLAN. A primary VLAN and secondary VLANs are in the one-to-many relationship.

❖ Layer-3 Association of PVLAN

In PVLAN, Layer-3 interfaces, that is, switched virtual interfaces (SVIs) can be created only in a primary VLAN. Users in a secondary VLAN can make Layer-3 communication only after Layer-3 association is performed between the secondary VLAN and the primary VLAN. Otherwise, the users can make only Layer-2 communication.

❖ Isolated Port

A port in an isolated VLAN can communicate only with a promiscuous port. An isolated port can forward the received packets to a Trunk port but a Trunk port cannot forward the packets with the VID of an isolated VLAN to an isolated port.

❖ Community Port

Community ports are ports in a community VLAN. Community ports in the same community VLAN can communicate with each other and can communicate with promiscuous ports. They cannot communicate with community ports in other community VLANs or isolated ports in an isolated VLAN.

❖ Promiscuous Port

Promiscuous ports are ports in a primary VLAN. They can communicate with any ports, including isolated ports and community ports in secondary VLANs of the same PVLAN domain.

❖ Promiscuous Trunk Port

A promiscuous Trunk port is a member port that belongs to multiple common VLANs and multiple PVLANS at the same time. It can communicate with any ports in the same VLAN.

- In a common VLAN, packet forwarding complies with 802.1Q.
- In PVLAN, for tagged packets to be forwarded by a promiscuous Trunk port, if the VID of the packets is a secondary VLAN ID, the VID is converted into the corresponding primary VLAN ID before packet forwarding.

❖ Isolated Trunk Port

An isolated Trunk port is a member port that belongs to multiple common VLANs and multiple PVLANS at the same time.

- In an isolated VLAN, an isolated Trunk port can communicate only with a promiscuous port.
- In a community VLAN, an isolated Trunk port can communicate with community ports in the same community VLAN and promiscuous ports.
- In a common VLAN, packet forwarding complies with 802.1Q.
- An isolated Trunk port can forward the received packets of an isolated VLAN ID to a Trunk port but a Trunk port cannot forward the packets with the VID of an isolated VLAN to an isolated port.
- For tagged packets to be forwarded by an isolated Trunk port, if the VID of the packets is a primary VLAN ID, the VID is converted into a secondary VLAN ID before packet forwarding.

In PVLAN, SVIs can be created only in a primary VLAN and SVIs cannot be created in secondary VLANs.

Ports in PVLAN can be used as mirroring source ports but cannot be used as mirroring destination ports.

Overview

Feature	Description
PVLAN Layer-2 Isolation and IP	Ports of different PVLAN types can be configured to implement interworking and isolation of VLAN intermediate user hosts.

[Address Saving](#)

After Layer-2 mapping is performed between a primary VLAN and secondary VLANs, only Layer-2 communication is supported. If Layer-3 communication is required, users in a secondary VLAN need to use SVIs of the primary VLAN to make Layer-3 communication.

9.3.1 PVLAN Layer-2 Isolation and IP Address Saving

Add users to subdomains of PVLAN to isolate communication between enterprises and between enterprise users.

Working Principle

Configure PVLAN, configure Layer-2 association and Layer-3 association between a primary VLAN and SubVLANs of PVLAN, and configure ports connected to user hosts, external network devices, and servers as different types of PVLAN ports. In this way, subdomain division and communication of users in subdomains with the external network and servers can be implemented.

❖ Packet Forwarding Relationship Between Ports of Different Types

Output Port \ Input Port	Promiscuous Port	Isolated Port	Community Port	Isolated Trunk Port (in the Same VLAN)	Promiscuous Trunk Port (in the Same VLAN)	Trunk Port (in the Same VLAN)
Promiscuous Port	Supported	Supported	Supported	Supported	Supported	Supported
Isolated Port	Supported	Unsupported	Unsupported	Unsupported	Supported	Supported
Community Port	Supported	Unsupported	Supported	Supported	Supported	Supported
Isolated Trunk Port (in the Same VLAN)	Supported	Unsupported	Supported	Unsupported (unsupported in an isolated VLAN but supported in a non-isolated VLAN)	Supported	Supported
Promiscuous Trunk Port (in the Same VLAN)	Supported	Supported	Supported	Supported	Supported	Supported
Trunk Port (in the Same VLAN)	Supported	Unsupported	Supported	Unsupported (unsupported in an isolated VLAN but supported in a non-isolated VLAN)	Supported	Supported

❖ VLAN Tag Changes After Packet Forwarding Between Ports of Different Types

Output Port Input Port	Promiscuous Port	Isolated Port	Community Port	Isolated Trunk Port (in the Same VLAN)	Promiscuous Trunk Port (in the Same VLAN)	Trunk Port (in the Same VLAN)
Promiscuous Port	Unchanged	Unchanged	Unchanged	A secondary VLAN ID is added.	A primary VLAN ID tag is added and the VLAN tag keeps unchanged in the non-PVLAN.	A primary VLAN ID tag is added.
Isolated Port	Unchanged	NA	NA	NA	A primary VLAN ID tag is added and the VLAN tag keeps unchanged in the non-PVLAN.	An isolated VLAN ID tag is added.
Community Port	Unchanged	NA	Unchanged	A community VLAN ID tag is added.	A primary VLAN ID tag is added and the VLAN tag keeps unchanged in the non-PVLAN.	A community VLAN ID tag is added.
Isolated Trunk Port (in the Same VLAN)	The VLAN tag is removed.	NA	The VLAN tag is removed.	The VLAN tag keeps unchanged in a non-isolated VLAN.	A primary VLAN ID tag is added and the VLAN tag keeps unchanged in the non-PVLAN.	Unchanged
Promiscuous Trunk Port (in the Same VLAN)	The VLAN tag is removed.	Unchanged	Unchanged	A secondary VLAN ID is added.	A primary VLAN ID tag is added and the VLAN tag keeps unchanged in the non-PVLAN.	Unchanged
Trunk Port (in the Same VLAN)	The VLAN tag is removed.	NA	The VLAN tag is removed.	The VLAN tag is converted into a secondary VLAN ID in a primary VLAN and the VLAN tag keeps unchanged in other non-isolated VLANs.	A primary VLAN ID tag is added and the VLAN tag keeps unchanged in the non-PVLAN.	Unchanged
Switch CPU	Untag	Untag	Untag	A secondary VLAN ID tag is added.	A primary VLAN ID tag is added and the VLAN tag keeps unchanged in the non-PVLAN.	A primary VLAN ID tag is added.

9.4 Configuration

Configuration	Description and Command
	(Mandatory) It is used to configure a primary VLAN and secondary VLANs.
private-vlan {community isolated primary}	Configures the PVLAN type.
	(Mandatory) It is used to configure Layer-2 association between a primary VLAN and secondary VLANs of PVLAN to form PVLAN pairs.
private-vlan association {svlist add svlist remove svlist}	Configures Layer-2 association between a primary VLAN and secondary VLANs to form PVLAN pairs.
	(Optional) It is used to allocate users to an isolated VLAN or community VLAN.
switchport mode private-vlan host	Configures a PVLAN host port.
switchport private-vlan host-association p_vid s_vid	Associates Layer-2 ports with PVLAN and allocates ports to subdomains.
	(Optional) It is used to configure a port as a promiscuous port.
Switchport mode private-vlan promiscuous	Configures a PVLAN promiscuous port.
switchport private-vlan mapping p_vid { svlist add svlist remove svlist }	Configures the primary VLAN to which a PVLAN promiscuous port belongs and a list of secondary VLANs. PVLAN packets can be transmitted or received through this port only after the configuration is performed.
	(Optional) It is used to allocate users to isolated Trunk ports to implement association of multiple PVLANS.
switchport private-vlan association trunk p_vid s_vid	Configures a port connected to a user host as an isolated Trunk port after PVLAN is created and Layer-2 association is performed. Ports of this type support association with multiple PVLAN pairs. The <i>p_vid</i> and <i>s_vid</i> parameters indicate the primary VLAN and isolated VLAN respectively.
	(Optional) It is used to allocate users to promiscuous Trunk ports to implement association of multiple PVLANS.

[Configuring Basic Functions of PVLAN](#)

Configuration	Description and Command
	<p>Configures a port connected to a user host as a promiscuous Trunk port after PVLAN is created and Layer-2 association is performed. Ports of this type support association with multiple PVLAN pairs. The <i>p_vid</i> and <i>s_list</i> parameters indicate the primary VLAN ID and secondary VLAN ID list respectively.</p>
	<p>switchport private-vlan promiscuous trunk <i>p_vid s_list</i></p>
	<p>(Optional) It is used to configure Layer-3 communication for users in a secondary VLAN.</p>
	<p>Configures the SVI of the primary VLAN and configures Layer-3 association between the primary VLAN and secondary VLANs after PVLAN is created and Layer-2 association is performed. Users in a SubVLAN can make Layer-3 communication through the SVI of the primary VLAN.</p>
	<p>private-vlan mapping { <i>svlist</i> add <i>svlist</i> remove <i>svlist</i> }</p>

9.4.1 Configuring Basic Functions of PVLAN

Configuration Effect

- Enable PVLAN subdomains to form to implement isolation between enterprises and between enterprise users.
- Implement Layer-3 mapping between multiple secondary VLANs and the primary VLAN so that and multiple VLANs uses the same IP gateway, thereby helping save IP addresses.

Notes

- After a primary VLAN and a secondary VLAN are configured, a PVLAN subdomain exist only after Layer-2 association is performed between them.
- A port connected to a use host must be configured as a specific PVLAN port so that the user host joins a subdomain to implement the real user isolation.
- The port connected to the external network and the port connected to a server must be configured as promiscuous ports so that upstream and downstream packets are forwarded normally.
- Users in a secondary VLAN can make Layer-3 communication through the SVI of the primary VLAN only after Layer-3 mapping is performed between the secondary VLAN and the primary VLAN.

Configurati on Steps

❖ Configuring PVLAN

- Mandatory.
- A primary VLAN and a secondary VLAN must be configured. The two types of VLANs cannot exist independently.
- Run the **private-vlan { community | isolated | primary }** command to configure a VLAN as the primary VLAN of PVLAN and other VLANs as secondary VLANs.

Command	private-vlan { community isolated primary }
Parameter Description	<p>community: Specifies that the VLAN type is community VLAN.</p> <p>isolated: Specifies that the VLAN type is isolated VLAN.</p> <p>primary: Specifies that the VLAN type is the primary VLAN of a PVLAN pair.</p>
Defaults	VLANs are common VLANs and do not have the attributes of PVLAN.
Command Mode	VLAN mode
Usage Guide	This command is used to specify the primary VLAN and secondary VLANs of PVLAN.

❖ Configuring Layer-2 Association of PVLAN

- Mandatory.
- PVLAN subdomains form, and isolated ports, community ports, and Layer-3 association can be configured only after Layer-2 association is performed between the primary VLAN and secondary VLANs of PVLAN.
- By default, after various PVLANS are configured, the primary VLANs and secondary VLANs are independent of each other. A primary VLAN has a secondary VLAN and a secondary VLAN has a primary VLAN only after Layer-2 association is performed.
- Run the **private-vlan association { svlist | add svlist | remove svlist }** command to configure or cancel the Layer-2 association between the primary VLAN and secondary VLANs of PVLAN. A PVLAN subdomain forms only after Layer-2 association is configured,. The PVLAN subdomain does not exist after Layer-2 association is cancelled. If Layer-2 association is not performed, when isolated ports and promiscuous ports are used to configure associated PVLAN pairs, the configuration will fail or the association between ports and VLANs will be cancelled.

Command	private-vlan association { svlist add svlist remove svlist }
Parameter Description	<p>svlist: Specifies the list of secondary VLANs to be associated or disassociated.</p> <p>add svlist: Adds the secondary VLANs to be associated.</p> <p>remove svlist: Cancels the association between <i>svlist</i> and the primary VLAN.</p>

Defaults	By default, the primary VLAN and secondary VLANs are not associated.
Command Mode	Primary VLAN mode of PVLAN
Usage Guide	<p>This command is used to configure Layer-2 association between a primary VLAN and secondary VLANs to form PVLAN pairs.</p> <p>Each primary VLAN can be associated with only one isolated VLAN but can be associated with multiple community VLANs.</p>

❖ Configuring Layer-3 Association of PVLAN

- If users in a secondary VLAN domain needs to make Layer-3 communication, configure a Layer-3 interface SVI for the primary VLAN and then configure Layer-3 association between the primary VLAN and secondary VLANs on the SVI.
- By default, SVIs can be configured only in a primary VLAN. Secondary VLANs do not support Layer-3 communication.
- If users in a secondary VLAN of PVLAN need to make Layer-3 communication, the SVI of the primary VLAN needs to be used to transmit and receive packets.
- Run the **private-vlan mapping { svlist | add svlist | remove svlist }** command to configure or cancel the Layer-3 association between the primary VLAN and secondary VLANs of PVLAN. Users in a secondary VLAN can make Layer-3 communication with the external network only after Layer-3 association is configured. After Layer-3 association is cancelled, users in a secondary VLAN cannot make Layer-3 communication.

Command	private-vlan mapping { svlist add svlist remove svlist }
Parameter Description	<p>svlist: Indicates the list of secondary VLANs, for which Layer-3 mapping needs to be configured.</p> <p>add svlist: Adds the secondary VLANs to be associated with a Layer-3 interface.</p> <p>remove svlist: Cancels the secondary VLANs associated with a Layer-3 interface.</p>
Defaults	By default, the primary VLAN and secondary VLANs are not associated.
Command Mode	Interface configuration mode of the primary VLAN
Usage Guide	<p>A Layer-3 SVI must be configured for the primary VLAN first.</p> <p>Layer-3 interfaces can be configured only in a primary VLAN.</p> <p>Layer-2 association must be performed between associated secondary VLANs and the primary VLAN.</p>

❖ Configuring Isolated Ports and Community Ports

- After the primary VLAN and secondary VLANs of PVLAN as well as Layer-2 association are configured, allocate the device ports connected to user hosts so as to specify the subdomains to which the user hosts belong.
- If an enterprise has only one user host, set the port connected to the user host as an isolated port.

- If an enterprise has multiple user hosts, set the ports connected to the user hosts as community ports.

Command	switchport mode private-vlan host switchport private-vlan host-association <i>p_vid s_vid</i>
Parameter Description	<i>p_vid</i> : Indicates the primary VLAN ID in a PVLAN pair. <i>s_vid</i> : Indicates the secondary VLAN ID in a PVLAN pair. The port is an associated port if the VLAN is an isolated VLAN and the port is a community port if the VLAN is a community VLAN.
Defaults	By default, the interface works in Access mode; no private VLAN pairs are associated.
Command Mode	Both commands run in interface configuration mode.
Usage Guide	Both the preceding commands need to be configured. Before a port is configured as an isolated port or promiscuous port, and the port mode must be configured as the host port mode. Whether a port is configured as an isolated port or community port depends on the <i>s_vid</i> parameter. <i>p_vid</i> and <i>s_vid</i> must be respectively the IDs of the primary VLAN and secondary VLAN in a PVLAN pair, on which Layer-2 association is performed. One host port can be associated with only one PVLAN pair.

❖ Configuring a Promiscuous Port

- According to the table listing port packet transmission and receiving rules in section "Features", the single port type of PVLAN cannot ensure symmetric forwarding of upstream and downstream packets. Ports for connecting to the external network or server need to be configured as promiscuous ports to ensure that users can successfully access the external network or server.

Command	switchport mode private-vlan promiscuous switchport private-vlan mapping <i>p_vid</i> { <i>svlist</i> add <i>svlist</i> remove <i>svlist</i> }
Parameter Description	<i>p_vid</i> : Indicates the primary VLAN ID in a PVLAN pair. <i>svlist</i> : Indicates the secondary VLAN associated with a promiscuous port. Layer-2 association must be performed between it and <i>p_vid</i> . add <i>svlist</i> : Adds a secondary VLAN to be associated with a port. remove <i>svlist</i> : Cancels the secondary VLAN associated with a port.
Defaults	By default, an interface works in Access mode; a promiscuous port is not associated with a secondary VLAN.
Command Mode	Interface configuration mode
Usage Guide	The port mode must be configured as the promiscuous mode. If a port is configured as a promiscuous port, it must be associated with PVLN pairs. Otherwise, the port cannot bear or forward services. One promiscuous port can be associated with multiple PVLAN pairs within one primary VLAN but cannot be

	associated with multiple primary VLANs.
--	---

❖ Configuring an Isolated Trunk Port and Associating the Port with a PVLAN Pair of a Layer-2 Interface

- When a downlink device of a device does not support PVLAN, if a port needs to isolate packets of some VLANs, the port must be configured as an isolated Trunk port and the association between the port and a PVLAN pair of a Layer-2 interface must be configured.
- After a port is configured as an isolated Trunk port, the port serves as a PVLAN uplink port. When the port receives packets with the VLAN tag of a PVLAN, the port serves as the isolated port of the PVLAN. When the port receives other packets, the port serves as a common Trunk port.

Command	switchport mode trunk switchport private-vlan association trunk <i>p_vid s_vid</i>
Parameter Description	<i>p_vid</i> : Indicates the primary VLAN ID in a PVLAN pair. <i>s_vid</i> : Indicates the associated isolated VLAN. Layer-2 association must be performed between it and <i>p_vid</i> .
Command Mode	Interface configuration mode
Usage Guide	The associated PVLAN must be a VLAN pair on which Layer-2 association is performed. The interface must work in Trunk port mode. One Trunk port can be associated with multiple PVLAN pairs.

❖ Configuring a Promiscuous Trunk Port and Associating the Port with a PVLAN Pair of a Layer-2 Interface

- When the management VLAN and the primary VLAN of a device are not the same, if a port needs to allow packets of the management VLAN and primary VLAN at the same time, the port must be configured as a promiscuous Trunk port and the association between the port and a PVLAN pair of a Layer-2 interface must be configured.
- After a port is configured as a promiscuous Trunk port, the port serves as a PVLAN uplink port. When the port receives packets with the VLAN tag of a PVLAN, the port serves as the promiscuous port of the PVLAN. When the port receives other packets, the port serves as a common Trunk port.

Command	switchport mode trunk switchport private-vlan promiscuous trunk <i>p_vid s_list</i>
Parameter Description	<i>p_vid</i> : Indicates the primary VLAN ID in a PVLAN pair. <i>svlist</i> : Indicates the secondary VLAN associated with a promiscuous port. Layer-2 association must be performed between it and <i>p_vid</i> .
Command Mode	Interface configuration mode

Usage Guide	<p>The interface must work in Trunk port mode.</p> <p>Layer-2 association must be performed on the associated primary VLAN and secondary VLANs.</p>
--------------------	---

Verification

Make user hosts connected to PVLAN ports transmit and receive packets as per PVLAN port forwarding rules to implement isolation. Configure Layer-3 association to make users in the primary VLAN and secondary VLANs of the same PVLAN to share the same gateway IP address and make Layer-3 communication.

Configuration on Example

❖ Cross-Device Layer-2 Application of PVLAN

Figure 9-3	<p>The diagram illustrates a network topology for Private VLAN (PVLAN) configuration. At the top, an 'Internet' cloud is connected to a 'Gateway' router. The Gateway is connected to two switches, 'Switch A' and 'Switch B'. Switch A is connected to the Gateway via Gi 0/1 and Gi 0/5. Switch B is connected to the Gateway via Gi 0/1 and Gi 0/3. Switch A is connected to Enterprise A (Community VLAN 100) via Gi 0/2 and Gi 0/3. Switch B is connected to Enterprise B (Isolated VLAN 101) via Gi 0/2 and Enterprise C (Isolated VLAN 101) via Gi 0/1. Enterprise A (Community VLAN 100) is also connected to Switch B via Gi 0/3. The primary VLAN is 99. A legend indicates: A: Enterprise A, B: Enterprise B, C: Enterprise C.</p>
Configuration Steps	<ul style="list-style-type: none"> ➤ Configure all enterprises to be in the same PVLAN (primary VLAN 99 in this example). All enterprise users share the same Layer-3 interface through this VLAN to communicate with the external network. ➤ If an enterprise has multiple user hosts, allocate each enterprise to a different community VLAN (in this example, allocate Enterprise A to Community VLAN 100) to implement user communication inside an enterprise and isolate user communication between enterprises. ➤ If an enterprise has only one user host, allocate such enterprises to the same isolated VLAN (in this example, allocate Enterprise B and Enterprise C to Isolated VLAN 101) to isolate user communication between enterprises.

A	<pre>SwitchA#configure terminal Enter configuration commands, one per line. End with CNTL/Z. SwitchA(config)#vlan 99 SwitchA(config vlan)#private vlan primary SwitchA(config vlan)#exit SwitchA(config)#vlan 100 SwitchA(config vlan)#private vlan community SwitchA(config vlan)#exit SwitchA(config)#vlan 101 SwitchA(config vlan)#private vlan isolated SwitchA(config vlan)#exit SwitchA(config)#vlan 99 SwitchA(config vlan)#private vlan association 100 101 SwitchA(config vlan)#exit SwitchA(config)#interface range gigabitEthernet 0/2 3 SwitchA(config if range)#switchport mode private vlan host SwitchA(config if range)#switchport private vlan host association 99 100 SwitchA(config if range)#exit SwitchA(config)#interface gigabitEthernet 0/4 SwitchA(config if GigabitEthernet 0/4)#switchport mode private vlan host SwitchA(config if GigabitEthernet 0/4)#switchport private vlan host association 99 101 SwitchA(config)#interface gigabitEthernet 0/5 SwitchA(config if GigabitEthernet 0/5)#switchport mode trunk SwitchA(config if GigabitEthernet 0/5)#exit</pre>
B	<pre>SwitchB#configure terminal Enter configuration commands, one per line. End with CNTL/Z. SwitchB(config)#vlan 99 SwitchB(config vlan)#private vlan primary SwitchB(config vlan)#exit SwitchB(config)#vlan 100 SwitchB(config vlan)#private vlan community</pre>

	<pre>SwitchB(config vlan)#exit SwitchB(config)#vlan 101 SwitchB(config vlan)#private vlan isolated SwitchB(config vlan)#exit SwitchB(config)#vlan 99 SwitchB(config vlan)#private vlan association 100 101 SwitchB(config vlan)#exit SwitchB(config)#interface gigabitEthernet 0/2 SwitchB(config if GigabitEthernet 0/2)#switchport mode private vlan host SwitchB(config if GigabitEthernet 0/2)# switchport private vlan host association 99 101 SwitchB(config if GigabitEthernet 0/2)#exit SwitchB(config)#interface gigabitEthernet 0/3 SwitchB(config if GigabitEthernet 0/3)#switchport mode private vlan host SwitchB(config if GigabitEthernet 0/3)# switchport private vlan host association 99 100 SwitchB(config if GigabitEthernet 0/3)#exit SwitchB(config)#interface gigabitEthernet 0/1 SwitchB(config if GigabitEthernet 0/1)#switchport mode trunk SwitchB(config if GigabitEthernet 0/1)#exit</pre>
Verification	Check whether VLANs and ports are correctly configured, and check whether packet forwarding is correct according to packet forwarding rules in section "Features".
A	<pre>SwitchA#show running config ! vlan 99 private vlan primary private vlan association add 100 101 ! vlan 100 private vlan community ! vlan 101</pre>

	<pre>private vlan isolated ! interface GigabitEthernet 0/1 switchport mode private vlan promiscuous switchport private vlan mapping 99 add 100 101 ! interface GigabitEthernet 0/2 switchport mode private vlan host switchport private vlan host association 99 100 ! interface GigabitEthernet 0/3 switchport mode private vlan host switchport private vlan host association 99 100 ! interface GigabitEthernet 0/4 switchport mode private vlan host switchport private vlan host association 99 101 ! interface GigabitEthernet 0/5 switchport mode trunk ! SwitchA# show vlan private vlan VLAN Type Status Routed Ports Associated VLANs 99 primary active Disabled Gi0/1, Gi0/5 100 101 100 community active Disabled Gi0/2, Gi0/3, Gi0/5 99 101 isolated active Disabled Gi0/4, Gi0/5 99 ...</pre>
B	<pre>SwitchB#show running config ! vlan 99</pre>

```
private vlan primary
private vlan association add 100 101
!
vlan 100
private vlan community
!
vlan 101
private vlan isolated
!
interface GigabitEthernet 0/1
switchport mode trunk
!
interface GigabitEthernet 0/2
switchport mode private vlan host
switchport private vlan host association 99 101
!
interface GigabitEthernet 0/3
switchport mode private vlan host
switchport private vlan host association 99 100
```

Common Errors

- Layer-2 association is not performed between the primary VLAN and secondary VLANs of PVLAN, and a port VLAN list fails to be added when isolated ports, promiscuous ports, and community ports are configured.
- One host port fails to be associated with multiple PVLAN pairs.

Configurati on Example

- ❖ Layer-3 Application of PVLAN on a Single Device

Figure 9-4

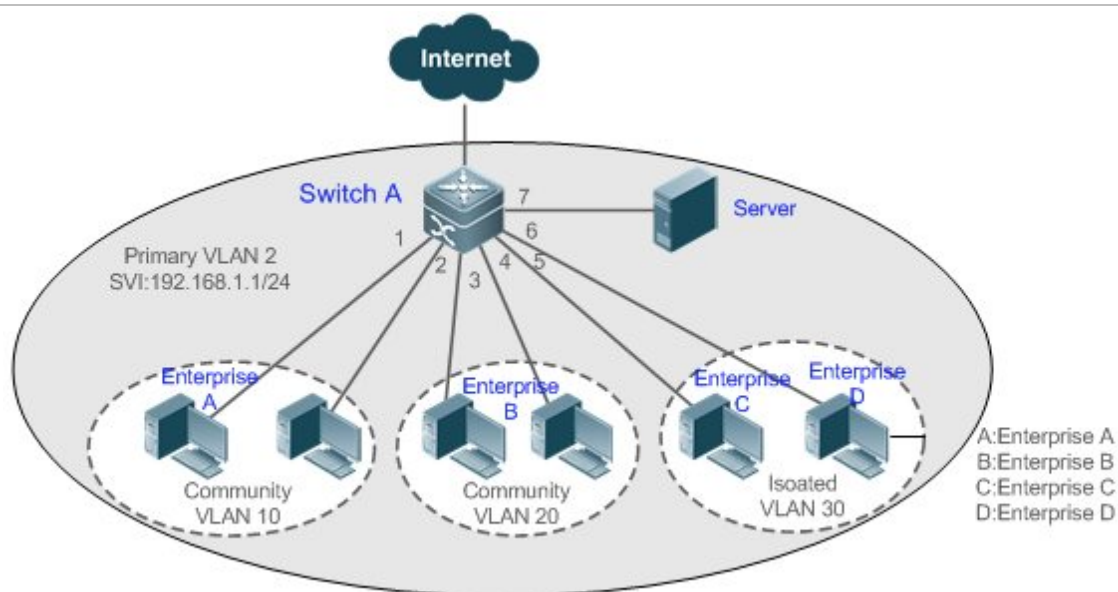

Configuration Steps

- Configure the PVLAN function on the device (Switch A in this example). For details about the configuration, see configuration tips in "Cross-Device Layer-2 Application of PVLAN."
- Set the port that is directly connected to the server (Port Gi 0/7 in this example) as a promiscuous port. Then, all enterprise users can communicate with the server through the promiscuous port.
- Configure the gateway address of PVLAN on the Layer-3 device (Switch A in this example) (in this example, set the SVI address of VLAN 2 to 192.168.1.1/24) and configure the Layer-3 interface mapping between the primary VLAN (VLAN 2 in this example) and secondary VLANs (VLAN 10, VLAN 20, and VLAN 30 in this example). Then, all enterprise users can communicate with the external network through the gateway address.

Run PVLAN cross devices and configure the ports for connecting to the devices as Trunk ports.

A

```
SwitchA#configure terminal
Enter configuration commands, one per line. End with CNTL/Z.
SwitchA(config)#vlan 2
SwitchA(config vlan)#private vlan primary
SwitchA(config vlan)#exit
SwitchA(config)#vlan 10
SwitchA(config vlan)#private vlan community
SwitchA(config vlan)#exit
```

```
SwitchA(config)#vlan 20
SwitchA(config vlan)#private vlan community
SwitchA(config vlan)#exit
SwitchA(config)#vlan 30
SwitchA(config vlan)#private vlan isolated
SwitchA(config vlan)#exit
SwitchA(config)#vlan 2
SwitchA(config vlan)#private vlan association 10,20,30
SwitchA(config vlan)#exit
SwitchA(config)#interface range gigabitEthernet 0/1 2
SwitchA(config if range)#switchport mode private vlan host
SwitchA(config if range)#switchport private vlan host association 2 10
SwitchA(config if range)#exit
SwitchA(config)#interface range gigabitEthernet 0/3 4
SwitchA(config if range)#switchport mode private vlan host
SwitchA(config if range)#switchport private vlan host association 2 20
SwitchA(config if range)#exit
SwitchA(config)#interface range gigabitEthernet 0/5 6
SwitchA(config if range)#switchport mode private vlan host
SwitchA(config if range)#switchport private vlan host association 2 30
SwitchA(config if range)#exit
SwitchA(config)#interface gigabitEthernet 0/7
SwitchA(config if GigabitEthernet 0/7)#switchport mode private vlan
promiscuous
SwitchA(config if GigabitEthernet 0/7)#switchport private vlan mapping 2
10,20,30
SwitchA(config if GigabitEthernet 0/7)#exit
SwitchA(config)#interface vlan 2
SwitchA(config if VLAN 2)#ip address 192.168.1.1 255.255.255.0
SwitchA(config if VLAN 2)#private vlan mapping 10,20,30
SwitchA(config if VLAN 2)#exit
```



Verification	Ping the gateway address 192.168.1.1 from user hosts in different subdomains. The ping operation is successful.
A	<pre>SwitchA#show running config ! vlan 2 private vlan primary private vlan association add 10,20,30 ! vlan 10 private vlan community ! vlan 20 private vlan community ! vlan 30 private vlan isolated ! interface GigabitEthernet 0/1 switchport mode private vlan host switchport private vlan host association 2 10 ! interface GigabitEthernet 0/2 switchport mode private vlan host switchport private vlan host association 2 10 ! interface GigabitEthernet 0/3 switchport mode private vlan host switchport private vlan host association 2 20 ! interface GigabitEthernet 0/4 switchport mode private vlan host switchport private vlan host association 2 20 !</pre>



```
interface GigabitEthernet 0/5
  switchport mode private vlan host
  switchport private vlan host association 2 30
!
interface GigabitEthernet 0/6
  switchport mode private vlan host
  switchport private vlan host association 2 30
!
interface GigabitEthernet 0/7
  switchport mode private vlan promiscuous
  switchport private vlan mapping 2 add 10,20,30
!
interface VLAN 2
  no ip proxy arp
  ip address 192.168.1.1 255.255.255.0
  private vlan mapping add 10,20,30
!
SwitchA#show vlan private vlan
VLAN Type Status Routed Ports Associated VLANs
2 primary active Enabled Gi0/7 10,20,30
10 community active Enabled Gi0/1, Gi0/2 2
20 community active Enabled Gi0/3, Gi0/4 2
30 isolated active Enabled Gi0/5, Gi0/6 2
```

❖ Common Errors

- No Layer-2 association is performed on the primary VLAN and secondary VLANs of PVLAN and the Layer-3 association fails to be configured.
- The device is connected to the external network before Layer-3 association is configured. As a result, the device cannot communicate with the external network.
- The interfaces for connecting to the server and the external network are not configured as promiscuous interfaces, which results in asymmetric forwarding of upstream and downstream packets.



9.5 Monitoring

Displaying

Description	Command
Displays PVLAN configuration.	show vlan private-vlan

Debugging

- System resources are occupied when debugging information is output. Therefore, disable debugging immediately after use.

Description	Command
-------------	---------



10. CONFIGURING MSTP

10.1 Overview

Spanning Tree Protocol (STP) is a Layer-2 management protocol. It cannot only selectively block redundant links to eliminate Layer-2 loops but also can back up links.

Similar to many protocols, STP is continuously updated from Rapid Spanning Tree Protocol (RSTP) to Multiple Spanning Tree Protocol (MSTP) as the network develops.

For the Layer-2 Ethernet, only one active link can exist between two local area networks (LANs). Otherwise, a broadcast storm will occur. To enhance the reliability of a LAN, it is necessary to establish a redundant link and keep some paths in backup state. If the network is faulty and a link fails, you must switch the redundant link to the active state. STP can automatically activate the redundant link without any manual operations. STP enables devices on a LAN to:

- Discover and start the best tree topology on the LAN.
- Troubleshoot a fault and automatically update the network topology so that the possible best tree topology is always selected.

The LAN topology is automatically calculated based on a set of bridge parameters configured by the administrator. The best topology tree can be obtained by properly configuring these parameters.

RSTP is completely compatible with 802.1D STP. Similar to traditional STP, RSTP provides loop-free and redundancy services. It is characterized by rapid speed. If all bridges in a LAN support RSTP and are properly configured by the administrator, it takes less than 1 second (about 50 seconds if traditional STP is used) to re-generate a topology tree after the network topology changes.

STP and RSTP have the following defects:

- STP migration is slow. Even on point-to-point links or edge ports, it still takes two times of the forward delay for ports to switch to the forwarding state.
- RSTP can rapidly converge but has the same defect with STP: Since all VLANs in a LAN share the same spanning tree, packets of all VLANs are forwarded along this spanning tree. Therefore, redundant links cannot be blocked according to specific VLANs and data traffic cannot be balanced among VLANs.

MSTP, defined by the IEEE in 802.1s, resolves defects of STP and RSTP. It cannot only rapidly converge but also can enable traffic of different VLANs to be forwarded along respective paths, thereby providing a better load balancing mechanism for redundant links.

In general, STP/RSTP works based on ports while MSTP works based on instances. An instance is a set of multiple VLANs. Binding multiple VLANs to one instance can reduce the communication overhead and resource utilization.

Qtech devices support STP, RSTP, and MSTP, and comply with IEEE 802.1D, IEEE 802.1w, and IEEE 802.1s.

Protocols and Standards

- IEEE 802.1D: Media Access Control (MAC) Bridges
- IEEE 802.1w: Part 3: Media Access Control (MAC) Bridges—Amendment 2: Rapid Reconfiguration
- IEEE 802.1s: Virtual Bridged Local Area Networks—Amendment 3: Multiple Spanning Trees

10.2 Applications

Application	Description
MSTP+VRRP Dual-Core Topology	With a hierarchical network architecture model, the MSTP+VRRP mode is used to implement redundancy and load balancing to improve system availability of the network.
BPDU Tunnel	In QinQ network environment, Bridge Protocol Data Unit (BPDU) Tunnel is used to implement tunnel-based transparent transmission of STP packets.

10.2.1 MSTP+VRRP Dual-Core Topology

Scenario

The typical application of MSTP is the MSTP+VRRP dual-core solution. This solution is an excellent solution to improve system availability of the network. Using a hierarchical network architecture model, it is generally divided into three layers (core layer, convergence layer, and access layer) or two layers (core layer and access layer). They form the core network system to provide data exchange service.

The main advantage of this architecture is its hierarchical structure. In the hierarchical network architecture, all capacity indicators, characteristics, and functions of network devices at each layer are optimized based on their network locations and roles, enhancing their stability and availability.

Figure 10-1 MSTP+VRRP Dual-Core Topology

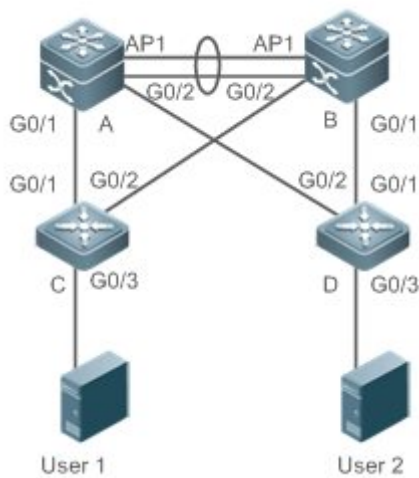

Remark s	The topology is divided into two layers: core layer (Devices A and B) and access layer (Devices C and D).
--------------------	---

Deployment

- Core layer: Multiple MSTP instances are configured to realize load balancing. For example, two instances are created: Instance 1 and Instance 2. Instance 1 maps VLAN 10 while Instance 2 maps VLAN 20. Device A is the root bridge of Instances 0 and 1 (Instance 0 is CIST, which exists by default). Device B is the root bridge of Instance 2.
- Core layer: Devices A and B are the active VRRP devices respectively on VLAN 10 and VLAN 20.
- Access layer: Configure the port directly connected to the terminal (PC or server) as a PortFast port, and enable BPDU guard to prevent unauthorized users from accessing illegal devices.

10.2.2 BPDU Tunnel

Scenario

The QinQ network is generally divided into two parts: customer network and service provider (SP) network. You can enable BPDU Tunnel to calculate STP packets of the customer network independently of the SP network, thereby preventing STP packets between the customer network from affecting the SP network.

Figure 10-2 BPDU Tunnel Topology

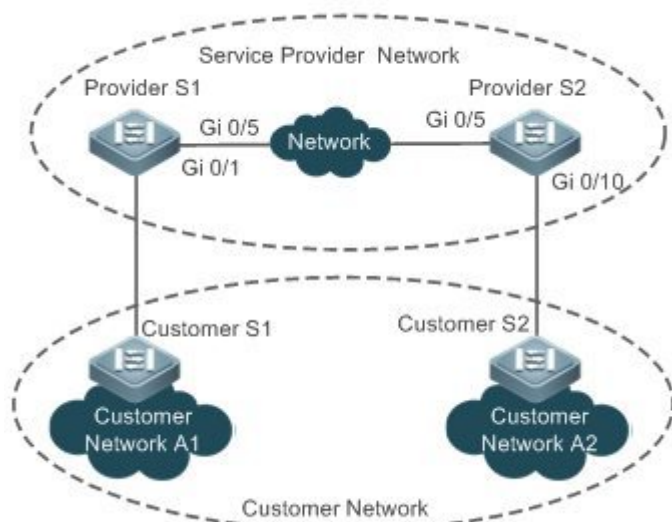

Remarks	<p>As shown in the above figure, the upper part is the SP network and the lower part is the customer network. The SP network consists of two provider edges (PEs): Provider S1 and Provider S2. Customer Network A1 and Customer Network A2 are a user's two sites in different regions. Customer S1 and Customer S2, access devices from the customer network to the SP network, access the SP network respectively through Provider S1 and Provider S2.</p> <p>Using BPDU Tunnel, Customer Network A1 and Customer Network A2 in different regions can perform unified spanning tree calculation across the SP network, not affecting the spanning tree calculation of the SP network.</p>
----------------	--

Deployment

t

- Enable basic QinQ on the PEs (Provider S1/Provider S2 in this example) so that data packets of the customer network are transmitted within the specified VLAN on the SP network.
- Enable STP transparent transmission on the PEs (Provider S1/Provider S2 in this example) so that the SP network can transmit STP packets of the customer network through BPDU Tunnel.

10.3 Features

Basic

Concepts

❖ BPDU

To generate a stable tree topology network, the following conditions must be met:

- Each bridge has a unique ID consisting of the bridge priority and MAC address.
- The overhead of the path from the bridge to the root bridge is called root path cost.

- A port ID consists of the port priority and port number.

Bridges exchange BPDU packets to obtain information required for establishing the best tree topology. These packets use the multicast address 01-80-C2-00-00-00 (hexadecimal) as the destination address.

A BPDU consists of the following elements:

- Root bridge ID assumed by the local bridge
- Root path cost of the local bridge
- Bridge ID (ID of the local bridge)
- Message age (age of a packet)
- Port ID (ID of the port sending this packet)
- **Forward-Delay Time, Hello Time, Max-Age Time** are time parameters specified in the MSTP.
- Other flags, such as flags indicating network topology changes and local port status.

If a bridge receives a BPDU with a higher priority (smaller bridge ID and lower root path cost) at a port, it saves the BPDU information at this port and transmits the information to all other ports. If the bridge receives a BPDU with a lower priority, it discards the information.

Such a mechanism allows information with higher priorities to be transmitted across the entire network. BPDU exchange results are as follows:

- A bridge is selected as the root bridge.
- Except the root bridge, each bridge has a root port, that is, a port providing the shortest path to the root bridge.
- Each bridge calculates the shortest path to the root bridge.
- Each LAN has a designated bridge located in the shortest path between the LAN and the root bridge. A port designated to connect the bridge and the LAN is called designated port.
- The root port and designated port enter the forwarding status.

❖ Bridge ID

According to IEEE 802.1W, each bridge has a unique ID. The spanning tree algorithm selects the root bridge based on the bridge ID. The bridge ID consists of eight bytes, of which the last six bytes are the MAC address of the bridge. In its first two bytes (as listed in the following table), the first four bits indicate the priority; the last eight bits indicate the system ID for use in extended protocol. In RSTP, the system ID is 0. Therefore, the bridge priority should be an integral multiple of 4,096.

	Bit	Value
Priority value	16	32,768

	15	16,384
	14	8,192
	13	4,096
System ID	12	2,048
	11	1,024
	10	512
	9	256
	8	128
	7	64
	6	32
	5	16
	4	8
	3	4
	2	2
	1	1

❖ Spanning-Tree Timers

The following three timers affect the performance of the entire spanning tree:

- Hello timer: Interval for periodically sending a BPDU packet.
- Forward-Delay timer: Interval for changing the port status, that is, interval for a port to change from the listening state to the learning state or from the learning state to the forwarding state when RSTP runs in STP-compatible mode.
- Max-Age timer: The longest time-to-live (TTL) of a BPDU packet. When this timer elapses, the packet is discarded.

❖ Port Roles and Port States

Each port plays a role on a network to reflect different functions in the network topology.

- Root port: Port providing the shortest path to the root bridge.
- Designated port: Port used by each LAN to connect the root bridge.
- Alternate port: Alternative port of the root port. Once the root port loses effect, the alternate port immediately changes to the root port.
- Backup port: Backup port of the designated port. When a bridge has two ports connected to a LAN, the port with the higher priority is the designated port while the port with the lower priority is the backup port.
- Disabled port: Inactive port. All ports with the operation state being down play this role.

The following figures show the roles of different ports:

R = Root port D = Designated port A = Alternate port B = Backup port

Unless otherwise specified, port priorities decrease from left to right.

Figure 10-3

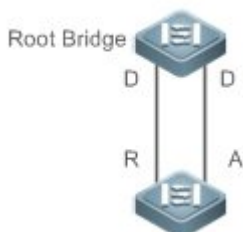

Figure 10-4

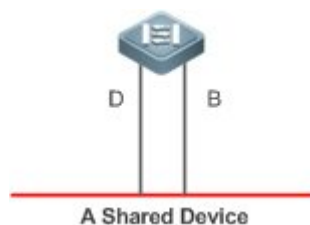
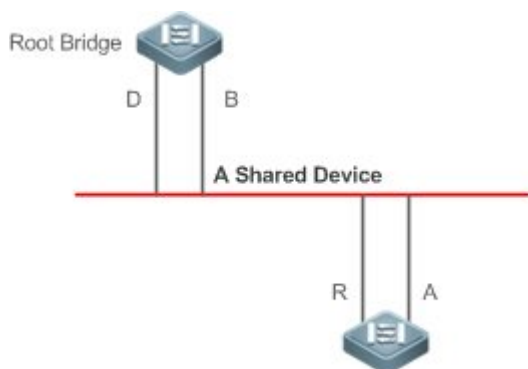

Figure 10-5



Each port has three states indicating whether to forward data packets so as to control the entire spanning tree topology.

- Discarding: Neither forwards received packets nor learns the source MAC address.
- Learning: Does not forward received packets but learns the source MAC address, which is a transitive state.
- Forwarding: Forwards received packets and learns the source MAC address.

For a stable network topology, only the root port and designated port can enter the forwarding state while other ports are always in discarding state.

❖ Hop Count

Internal spanning trees (ISTs) and multiple spanning tree instances (MSTIs) calculate whether the BPDU packet time expires based on an IP TTL-alike mechanism Hop Count, instead of Message Age and Max Age.

It is recommended to run the **spanning-tree max-hops** command in global configuration mode to configure the hop count. In a region, every time a BPDU packet passes through a device from the root bridge, the hop count decreases by 1. When the hop count becomes 0, the BPDU packet time expires and the device discards the packet.

To be compatible with STP and RSTP outside the region, MSTP also retains the Message Age and Max Age mechanisms.

Overview

Feature	Description
STP	STP, defined by the IEEE in 802.1D, is used to eliminate physical loops at the data link layer in a LAN.
RSTP	RSTP, defined by the IEEE in 802.1w, is optimized based on STP to rapidly converge the network topology.
MSTP	MSTP, defined by the IEEE in 802.1s, resolves defects of STP, RSTP, and Per-VLAN Spanning Tree (PVST). It cannot only rapidly converge but also can forward traffic of different VLANs along respective paths, thereby providing a better load balancing mechanism for redundant links.
MSTP Optical Features	MSTP includes the following features: PortFast, BPDU guard, BPDU filter, TC protection, TC guard, TC filter, BPDU check based on the source MAC address, BPDU filter based on the illegal length, Auto Edge, root guard, and loop guard.

10.3.1 STP

STP is used to prevent broadcast storms incurred by loops and provide link redundancy.

Working Principle

For the Layer-2 Ethernet, only one active link can exist between two LANs. Otherwise, a broadcast storm will occur. To enhance the reliability of a LAN, it is necessary to establish a redundant link and keep some paths in backup state. If the network is faulty and a link fails, you must switch the redundant link to the active state. STP can automatically activate the redundant link without any manual operations. STP enables devices on a LAN to:

- Discover and start the best tree topology on the LAN.
- Troubleshoot a fault and automatically update the network topology so that the possible best tree topology is always selected.

The LAN topology is automatically calculated based on a set of bridge parameters configured by the administrator. The best topology tree can be obtained by properly configuring these parameters.

Related Configurati on

- ❖ Enabling spanning-tree
 - By default, the spanning-tree function is disabled.
 - Run the **spanning-tree** [**forward-time** *seconds* | **hello-time** *seconds* | **max-age** *seconds*] command to enable STP and configure basic attributes.
 - The forward-time ranges from 4 to 30. The hello-time ranges from 1 to 10. The max-age ranges from 6 to 40.

Running the **clear** commands may lose vital information and thus interrupt services. The value ranges of forward-time, hello-time, and max-age are related. If one of them is modified, the other two ranges are affected. The three values must meet the following condition: $2 \times (\text{Hello Time} + 1 \text{ second}) \leq \text{Max-Age Time} \leq 2 \times (\text{Forward-Delay Time} - 1 \text{ second})$. Otherwise, the configuration will fail.

10.3.2 RSTP

RSTP is completely compatible with 802.1D STP. Similar to traditional STP, RSTP provides loop-free and redundancy services. It is characterized by rapid speed. If all bridges in a LAN support RSTP and are properly configured by the administrator, it takes less than 1 second (about 50 seconds if traditional STP is used) to re-generate a topology tree after the network topology changes.

Working Principle

- ❖ Fast RSTP Convergence

RSTP has a special feature, that is, to make ports quickly enter the forwarding state.

STP enables a port to enter the forwarding state 30 seconds (two times of the Forward-Delay Time; the Forward-Delay Time can be configured, with a default value of 15 seconds) after selecting a port role. Every time the topology changes, the root port and designated port reselected by each bridge enter the forwarding state 30 seconds later. Therefore, it takes about 50 seconds for the entire network topology to become a tree.

RSTP differs greatly from STP in the forwarding process. As shown in Figure 10-6, Switch A sends an RSTP Proposal packet to Switch B. If Switch B finds the priority of Switch A higher, it selects Switch A as the root bridge and the port receiving the packet as the root port, enters the forwarding state, and then sends an Agree packet from the root port to Switch A. If the designated port of Switch A is agreed, the port enters the forwarding state. Switch B's designated

port resends a Proposal packet to extend the spanning tree by sequence. Theoretically, RSTP can recover the network tree topology to rapidly converge once the network topology changes.

Figure 10-6

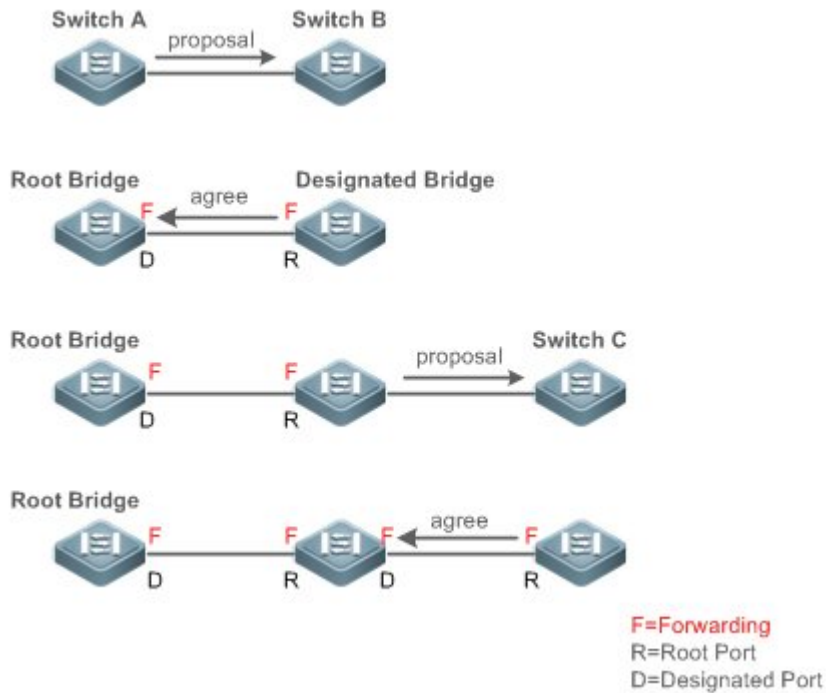

- The above handshake process is implemented only when the connection between ports is in point-to-point mode. To give the devices their full play, it is recommended not to enable point-to-point connection between devices.

Figure 10-7 and Figure 10-8 show the examples of non point-to-point connection.

Example of non point-to-point connection:

Figure 10-7

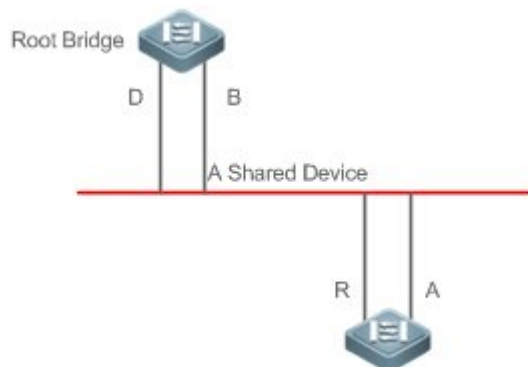

Figure 10-8

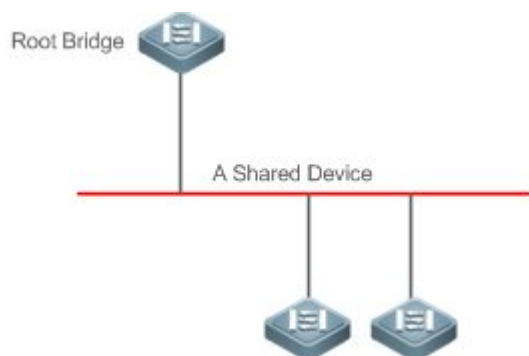
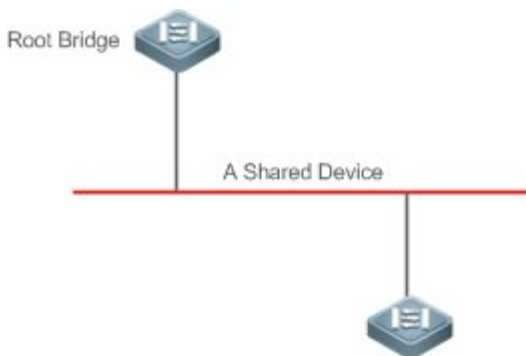

Figure 10-9 shows an example of point-to-point connection.

Figure 10-9



❖ Compatibility Between RSTP and STP

RSTP is completely compatible with STP. RSTP automatically checks whether the connected bridge supports STP or RSTP based on the received BPDU version number. If the port connects to an STP bridge, the port enters the forwarding state 30 seconds later, which cannot give RSTP its full play.

Another problem may occur when RSTP and STP are used together. As shown in the following figures, Switch A (RSTP) connects to Switch B (STP). If Switch A finds itself connected to an STP bridge, it sends an STP BPDU packet. However, if Switch B is replaced with Switch C (RSTP) but Switch A still sends STP BPDU packets, Switch C will assume itself connected to the STP bridge. As a result, two RSTP devices work under STP, greatly reducing the efficiency.

RSTP provides the protocol migration feature to forcibly send RSTP BPDU packets (the peer bridge must support RSTP). In this case, Switch A is enforced to send an RSTP BPDU and Switch C then finds itself connected to the RSTP bridge. As a result, two RSTP devices work under RSTP, as shown in Figure 10-11.

Figure 10-10

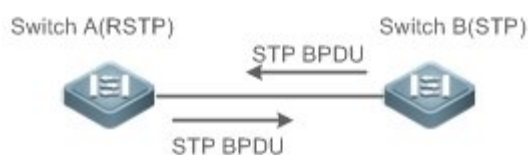
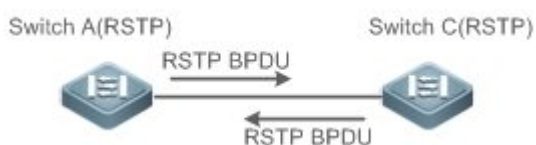

Figure 10-11



Related Configuration

❖ Configuring Protocol Migration

- Run the **clear spanning-tree detected-protocols [interface *interface-id*]** command to enforce version check on a port. For details, see "Compatibility Between RSTP and STP".

10.3.3 MSTP

MSTP resolves defects of STP and RSTP. It cannot only rapidly converge but also can forward traffic of different VLANs along respective paths, thereby providing a better load balancing mechanism for redundant links.

Working Principle

Qtech devices support MSTP. MSTP is a new spanning tree protocol developed from traditional STP and RSTP and includes the fast RSTP forwarding mechanism.

Since traditional spanning tree protocols are irrelevant to VLANs, problems may occur in specific network topologies:

As shown in

Figure 10-12, Devices A and B are in VLAN 1 while Devices C and D are in VLAN 2, forming a loop.

Figure 10-12

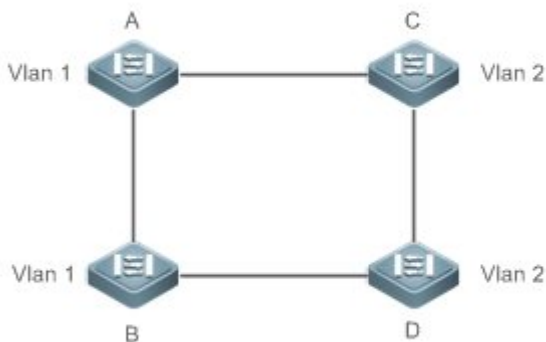

If the link from Device A to Device B through Devices C and D costs less than the link from Device A direct to Device B, the link between Device A and Device B enters the discarding state (as shown in Figure 10-13). Since Devices C and D do not include VLAN 1 and cannot forward data packets of VLAN 1, VLAN 1 of Device A fails to communicate with VLAN 1 of Device B.

Figure 10-13

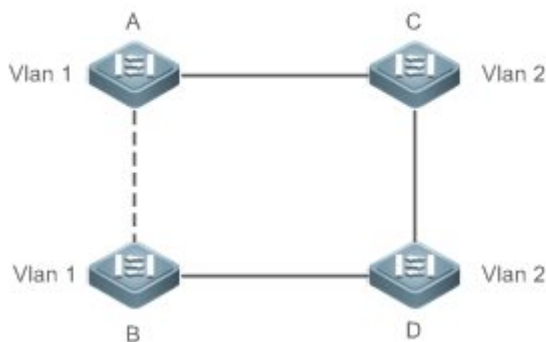

MSTP is developed to resolve this problem. It divides one or multiple VLANs of a device into an instance. Devices configured with the same instance form an MST region to run an independent spanning tree (called IST). This MST region, like a big device, implements the spanning tree algorithm with other MST regions to generate a complete spanning tree called common spanning tree (CST).

Based on this algorithm, the above network can form the topology shown in

Figure 10-14 under the MSTP algorithm: Devices A and B are in MSTP region 1 in which no loop occurs, and therefore no link enters the discarding state. This also applies to MSTP Region 2. Region 1 and Region 2, like two big devices having loops, select a link to enter the discarding state based on related configuration.

Figure 10-14

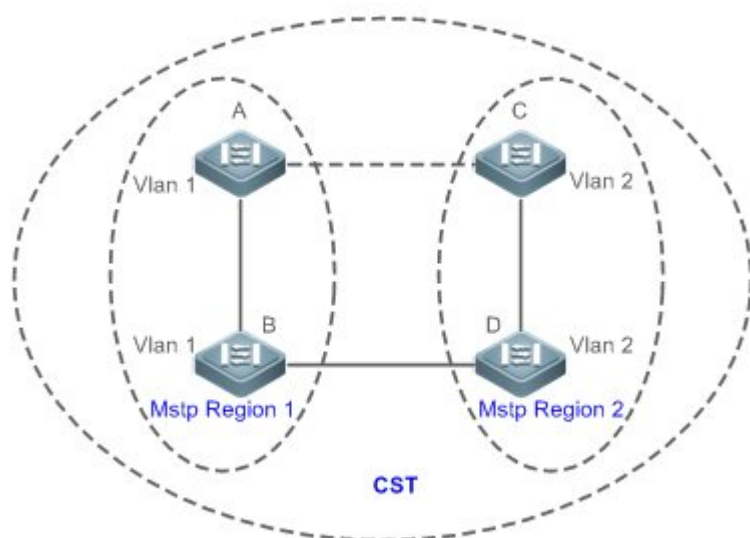

This prevents loops to ensure proper communication between devices in the same VLAN.

❖ MSTP Region Division

To give MSTP its due play, properly divide MSTP regions and configure the same MST configuration information for devices in the same MSTP region.

MST configuration information include:

- MST configuration name: Consists of at most 32 bytes to identify an MSTP region.
- MST Revision Number: Consists of 16 bits to identify an MSTP region.
- MST instance-VLAN mapping table: A maximum number of 64 instances (with their IDs ranging from 1 to 64) are created for each device and Instance 0 exists mandatorily. Therefore, the system supports a maximum number of 65 instances. Users can assign 1 to 4,994 VLANs belonging to different instances (ranging from 0 to 64) as required. Unassigned VLANs belong to Instance 0 by default. In this case, each MSTI is a VLAN group and implements the spanning tree algorithm of the MSTI specified in the BPDU packet, not affected by CIST and other MSTIs.

Run the **spanning-tree mst configuration** command in global configuration mode to enter the MST configuration mode to configure the above information.

MSTP BPDUs carry the above information. If the BPDU received by a device carries the same MST configuration information with the information on the device, it regards that the connected device belongs to the same MST region with itself. Otherwise, it regards the connected device originated from another MST region.

- It is recommended to configure the instance-VLAN mapping table after disabling MSTP. After the configuration, re-enable MSTP to ensure stability and convergence of the network topology.

❖ IST (Spanning Tree in an MSTP Region)

After MSTP regions are divided, each region selects an independent root bridge for each instance based on the corresponding parameters such as bridge priority and port priority, assigns roles to each port on each device, and specifies whether the port is in forwarding or discarding state in the instance based on the port role.

Through MSTP BPDUs exchange, an IST is generated and each instance has their own spanning trees (MSTIs), in which the spanning tree corresponding to Instance 0 and CST are uniformly called Common Instance Spanning Tree (CIST). That is, each instance provides a single and loop-free network topology for their own VLAN groups.

As shown in Figure 100-15, Devices A, B, and C form a loop in Region 1.

As shown in Figure 100-15, Device A has the highest priority in the CIST (Instance 0) and thereby is selected as the region root. Then MSTP enables the link between A and C to enter the discarding state based on other parameters. Therefore, for the VLAN group of Instance 0, only links from A to B and from B to C are available, interrupting the loop of this VLAN group.

Figure 100-15

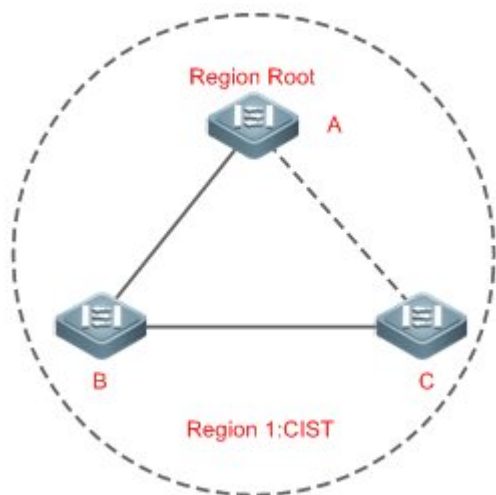

As shown in

Figure 10-16, Device B has the highest priority in the MSTI 1 (Instance 1) and thereby is selected as the region root. Then MSTP enables the link between B and C to enter the discarding state based on other parameters. Therefore, for the VLAN group of Instance 1, only links from A to B and from A to C are available, interrupting the loop of this VLAN group.

Figure 10-16

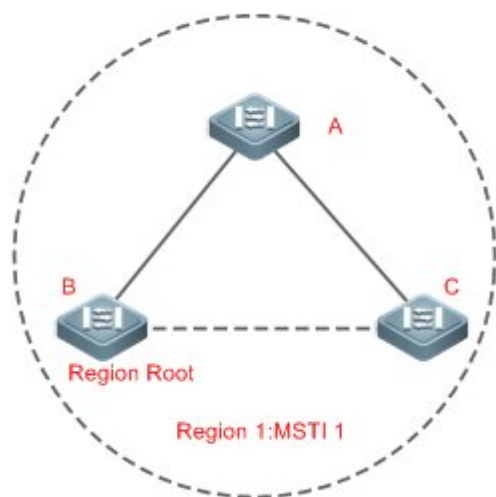

As shown in Figure 10-17, Device C has the highest priority in the MSTI 2 (Instance 2) and thereby is selected as the region root. Then MSTP enables the link between B and C to enter the discarding state based on other parameters. Therefore, for the VLAN group of Instance 2, only links from B to C and from A to C are available, interrupting the loop of this VLAN group.

Figure 10-17

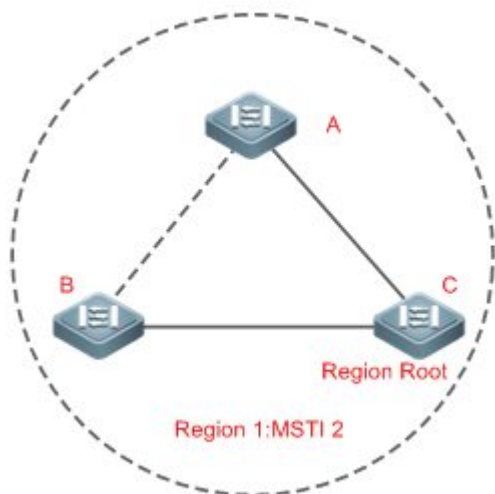

Note that MSTP does not care which VLAN a port belongs to. Therefore, users should configure the path cost and priority of a related port based on the actual VLAN configuration to prevent MSTP from interrupting wrong loops.

❖ CST (Spanning Tree Between MSTP Regions)

Each MSTP region is like a big device for the CST. Different MSTP regions form a bit network topology tree called CST. As shown in Figure 10-18, Device A, of which the bridge ID is the smallest,

is selected as the root in the entire CST and the CIST regional root in this region. In Region 2, since the root path cost from Device B to the CST root is lowest, Device B is selected as the CIST regional root in this region. For the same reason, Device C is selected as the CIST regional root.

Figure 10-18

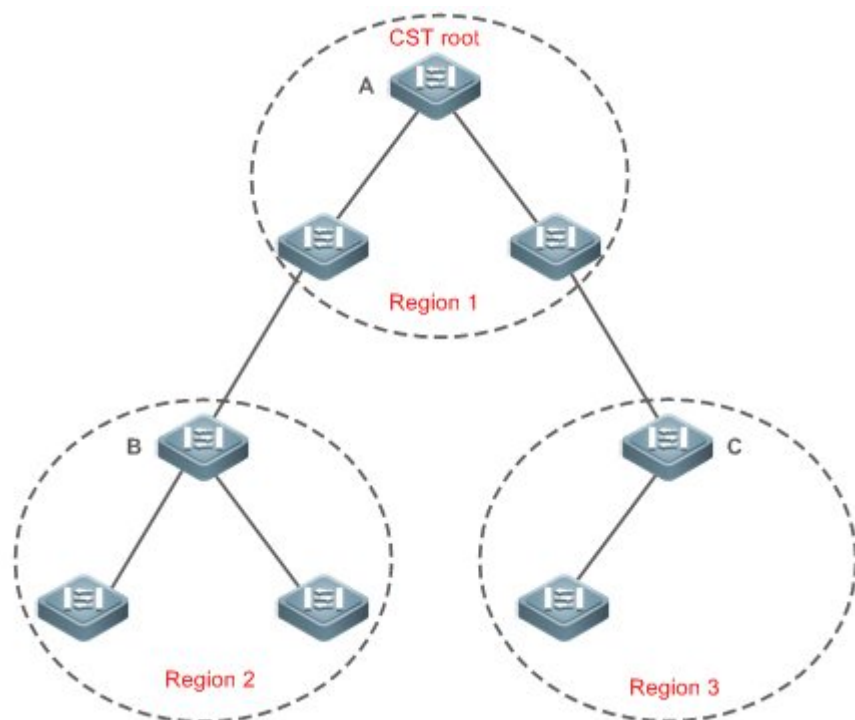

The CIST regional root may not be the device of which the bridge ID is the smallest in the region but indicates the device of which the root path cost from this region to the CST root is the smallest.

For the MSTI, the root port of the CIST regional root has a new role "master port". The master port acts as the outbound port of all instances and is in forwarding state for all instances. To make the topology more stable, we suggest that the master port of each region to the CST root be on the same device of the region if possible.

❖ Compatibility Among MSTP, RSTP, and STP

Similar to RSTP, MSTP sends STP BPDUs to be compatible with STP. For details, see "Compatibility Between RSTP and STP".

Since RSTP processes MSTP BPDUs of the CIST, MSTP does not need to send RSTP BPDUs to be compatible with it.

Each STP or RSTP device is a single region and does not form the same region with any devices.

Related Configurations

- ❖ Configuring STP
 - By default, the STP mode is MSTP mode.
 - Run **spanning-tree mode [stp | rstp | mstp]** to modify the STP mode.

10.3.4 MSTP Optional Features

MSTP optional features mainly include PortFast port, BPDU guard, BPDU filter, TC guard, and guard. The optional features are mainly used to deploy MSTP configurations based on the network topology and application characteristics in the MSTP network. This enhances the stability, robustness, and anti-attack capability of MSTP, meeting application requirements of MSTP in different customer scenarios.

Working Principle

❖ PortFast

If a port of a device connects directly to the network terminal, this port is configured as a PortFast port to directly enter the forwarding state. If the PortFast port is not configured, the port needs to wait for 30 seconds to enter the forwarding state. Figure 10-19 shows which ports of a device can be configured as PortFast ports.

Figure 10-19

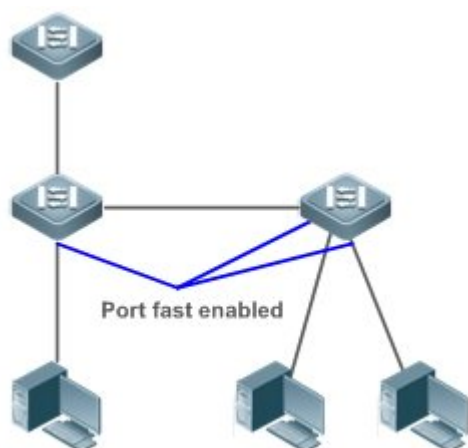

If a PortFast port still receives BPDUs, its Port Fast Operational State is Disabled and the port enters the forwarding state according to the normal STP algorithm.

❖ BPDU Guard

BPDU guard can be enabled globally or enabled on an interface.

It is recommended to run the **spanning-tree portfast bpduguard default** command in global configuration mode to enable global BPDU guard. If PortFast is enabled on a port or this port is automatically identified as an edge port, this port enters the error-disabled state to indicate the configuration error immediately after receiving a BPDU. At the same time, the port is disabled, indicating that a network device may be added by an unauthorized user to change the network topology.

It is also recommended to run the **spanning-tree bpduguard enable** command in interface configuration mode to enable BPDU guard on a port (whether PortFast is enabled or not on the port). In this case, the port enters the error-disabled state immediately after receiving a BPDU.

❖ BPDU Filter

BPDU filter can be enabled globally or enabled on an interface.

It is recommended to run the **spanning-tree portfast bpdufilter default** command in global configuration mode to enable global BPDU filter. In this case, the PortFast port neither receives nor sends BPDUs and therefore the host connecting directly to the PortFast port receives no BPDUs. If the port changes its Port Fast Operational State to Disabled after receiving a BPDU, BPDU filter automatically loses effect.

It is also recommended to run the **spanning-tree bpdufilter enable** command in interface configuration mode to enable BPDU filter on a port (whether PortFast is enabled or not on the port). In this case, the port neither receives nor sends BPDUs but directly enters the forwarding state.

❖ TC Protection

TC BPDUs are BPDU packets carrying the TC. If a switch receives such packets, it indicates the network topology changes and the switch will delete the MAC address table. For Layer-3 switches in this case, the forwarding module is re-enabled and the port status in the ARP entry changes. When a switch is attacked by forged TC BPDUs, it will frequently perform the above operations, causing heavy load and affecting network stability. To prevent this problem, you can enable TC protection.

TC protection can only be globally enabled or disabled. This function is disabled by default.

When TC protection is enabled, the switch deletes TC BPDUs within a specified period (generally 4 seconds) after receiving them and monitors whether any TC BPDU packet is received during the period. If a device receives TC BPDU packets during this period, it deletes them when the period expires. This can prevent the device from frequently deleting MAC address entries and ARP entries.

❖ TC Guard

TC protection ensures less dynamic MAC addresses and ARP entries removed when a large number of TC packets are generated on the network. However, a device receiving TC attack

packets still performs many removal operations and TC packets can be spread, affecting the entire network. Users can enable TC guard to prevent TC packets from spreading globally or on a port. If TC guard is enabled globally or on a port, a port receiving TC packets filters these TC packets or TC packets generated by itself so that TC packets will not be spread to other ports. This can effectively control possible TC attacks in the network to ensure network stability. Particularly on Layer-3 devices, this function can effectively prevent the access-layer device from flapping and interrupting the core route.

If TC guard is used incorrectly, the communication between networks is interrupted.

It is recommended to enable this function only when illegal TC attack packets are received in the network.

If TC guard is enabled globally, no port spreads TC packets to others. This function can be enabled only on laptop access devices.

If TC guard is enabled on a port, the topology changes incurred and TC packets received on the port will not be spread to other ports. This function can be enabled only on uplink ports, particularly on ports of the convergence core.

❖ TC Filter

If TC guard is enabled on a port, the port does not forward TC packets received and generated by the port to other ports performing spanning tree calculation on the device. When the status of a port changes (for example, from blocking to forwarding), the port generates TC packets, indicating that the topology may have changed.

In this case, since TC guard prevents TC packets from spreading, the device may not clear the MAC addresses of the port when the network topology changes, causing a data forwarding error.

To resolve this problem, TC filter is introduced. TC filter does not process TC packets received by ports but processes TC packets in case of normal topology changes. If TC filter is enabled, the address removal problem will be avoided and the core route will not be interrupted when ports not enabled with PortFast frequently go up or down, and the core routing entries can be updated in a timely manner when the topology changes.

TC filter is disabled by default.

❖ BPDU Source MAC Address Check

BPDU source MAC address check prevents BPDU packets from maliciously attacking switches and causing MSTP abnormal. When the switch connected to a port on a point-to-point link is determined, you can enable BPDU source MAC address check to receive BPDU packets sent only by the peer switch and discard all other BPDU packets, thereby preventing malicious attacks. You can enable the BPDU source MAC address check in interface configuration mode for a specific port. One port can only filter one MAC address. If you run the **no bpdu src-mac-check** command to disable BPDU source MAC address check on a port, the port receives all BPDU packets.

❖ BPDU Filter

If the Ethernet length of a BPDU exceeds 1,500, this BPDU will be discarded, preventing receipt of illegal BPDU packets.

❖ Auto Edge

If the designated port of a device does not receive a BPDU from the downlink port within a specific period (3 seconds), the device regards a network device connected to the designated port, configures the port as an edge port, and switches the port directly into the forwarding state. The edge port will be automatically identified as a non-edge port after receiving a BPDU.

You can run the **spanning-tree autoedge disabled** command to disable Auto Edge.

This function is enabled by default.

If Auto Edge conflicts with the manually configured PortFast, the manual configuration prevails.

Since this function is used for rapid negotiation and forwarding between the designated port and the downlink port, STP does not support this function. If the designated port is in forwarding state, the Auto Edge configuration does not take effect on this port. It takes only when rapid negotiation is re-performed, for example, when the network cable is removed and plugged.

If BPDU filter has been enabled on a port, the port directly enters the forwarding state and is not automatically identified as an edge port.

This function applies only to the designated port.

❖ Root Guard

In the network design, the root bridge and backup root bridge are usually divided into the same region. Due to incorrect configuration of maintenance personnel or malicious attacks in the network, the root bridge may receive configuration information with a higher priority and thereby switches to the backup root bridge, causing incorrect changes in the network topology. Root guard is to resolve this problem.

If root guard is enabled on a port, its roles on all instances are enforced as the designated port. Once the port receives configuration information with a higher priority, it enters the root-inconsistent (blocking) state. If the port does not receive configuration information with a higher priority within a period, it returns to its original state.

If a port enters the blocking state due to root guard, you can manually restore the port to the normal state by disabling root guard on this port or disabling spanning tree guard (running **spanning-tree guard none** in interface configuration mode).

If root guard is used incorrectly, the network link will be interrupted.

If root guard is enabled on a non-designated port, this port will be enforced as a designated port and enter the BKN state. This indicates that the port enters the blocking state due to root inconsistency.

If a port enters the BKN state due to receipt of configuration information with a higher priority in MST0, this port will be enforced in the BKN state in all other instances.

Root guard and loop guard cannot take effect on a port at the same time.

❖ Loop Guard

Due to the unidirectional link failure, the root port or backup port becomes the designated port and enters the forwarding state if it does not receive BPDUs, causing a network loop. Loop guard is to prevent this problem.

If a port enabled with loop guard does not receive BPDUs, the port switches its role but stays in discarding state till it receives BPDUs and recalculates the spanning tree.

You can enable loop guard globally or on a port.

Root guard and loop guard cannot take effect on a port at the same time.

Before MSTP is restarted on a port, the port enters the blocking state in loop guard. If the port still receives no BPDU after MSTP is restarted, the port will become a designated port and enter the forwarding state. Therefore, it is recommended to identify the cause why a port enters the blocking state in loop protection and rectify the fault as soon as possible before restarting MSTP. Otherwise, the spanning tree topology will still become abnormal after MSTP is restarted.

❖ BPDU Transparent Transmission

In IEEE 802.1Q, the destination MAC address 01-80-C2-00-00-00 of the BPDU is used as a reserved address. That is, devices compliant with IEEE 802.1Q do not forward the BPDU packets received. However, devices may need to transparently transmit BPDU packets in actual network deployment. For example, if STP is disabled on a device, the device needs to transparently transmit BPDU packets so that the spanning tree between devices is properly calculated.

BPDU transparent transmission is disabled by default.

BPDU transparent transmission takes effect only when STP is disabled. If STP is enabled on a device, the device does not transparently transmit BPDU packets.

❖ BPDU Tunnel

The QinQ network is generally divided into two parts: customer network and SP network. Before a user packet enters the SP network, it is encapsulated with the VLAN tag of an SP network and also retains the original VLAN tag as data. As a result, the packet carries two VLAN tags to pass through the SP network. In the SP network, packets are transmitted only based on the outer-layer VLAN tag. When packets leave the SP network, the outer-layer VLAN tag is removed.

The STP packet transparent transmission feature, namely BPDU Tunnel, can be used to realize the transmission of STP packets between the customer network without any impact on the SP network. If an STP packet sent from the customer network enters a PE, the PE changes the destination MAC address of the packet to a private address before the packet is forwarded by the

SP network. When the packet reaches the PE at the peer end, the PE changes the destination MAC address to a public address and returns the packet to the customer network at the peer end, realizing transparent transmission across the SP network. In this case, STP on the customer network is calculated independently of that on the SP network.

Related Configurati on

- ❖ Configuring PortFast
 - PortFast is disabled by default.
 - In global configuration mode, run the **spanning-tree portfast default** command to enable PortFast on all ports and the **no spanning-tree portfast default** command to disable PortFast on all ports.
 - In interface configuration mode, run the **spanning-tree portfast** command to enable PortFast on a port and the **spanning-tree portfast disabled** command to disable PortFast on a port.
- ❖ Configuring BPDU Guard
 - BPDU guard is disabled by default.
 - In global configuration mode, run the **spanning-tree portfast bpduguard default** command to enable BPDU guard on all ports and the **no spanning-tree portfast bpduguard default** command to disable BPDU guard on all ports.
 - In interface configuration mode, run the **spanning-tree bpduguard enabled** command to enable BPDU guard on a port and the **spanning-tree bpduguard disabled** command to disable BPDU guard on a port.
- ❖ Configuring BPDU Filter
 - BPDU Filter is disabled by default.
 - In global configuration mode, run the **spanning-tree portfast bpdufilter default** command to enable BPDU filter on all ports and the **no spanning-tree portfast bpdufilter default** command to disable BPDU filter on all ports.
 - In interface configuration mode, run the **spanning-tree bpdufilter enabled** command to enable BPDU filter on a port and the **spanning-tree bpdufilter disabled** command to disable BPDU filter on a port.
- ❖ Configuring TC Protection
 - TC protection is disabled by default.

- In global configuration mode, run the **spanning-tree tc-protection** command to enable TC protection on all ports and the **no spanning-tree tc-protection** command to disable TC protection on all ports.
- TC protection can only be enabled or disabled globally.
- ❖ Enabling TC Guard
 - TC guard is disabled by default.
 - In global configuration mode, run the **spanning-tree tc-protection tc-guard** command to enable TC guard on all ports and the **no spanning-tree tc-protection tc-guard** command to disable TC guard on all ports.
 - In interface configuration mode, run the **spanning-tree tc-guard** command to enable TC guard on a port and the **no spanning-tree tc-guard** command to disable TC guard on a port.
- ❖ Configuring TC Filter
 - TC filter is disabled by default.
 - In interface configuration mode, run the **spanning-tree ignore tc** command to enable TC filter on a port and the **no spanning-tree ignore tc** command to disable it on a port.
- ❖ Enabling BPDU Source MAC Address Check
 - BPDU Source MAC Address Check is disabled by default.
 - In interface configuration mode, run the **bpdu src-mac-check H.H.H** command to enable BPDU source MAC address check on a port and the **no bpdu src-mac-check** command to disable it on a port.
- ❖ Configuring Auto Edge
 - Auto Edge is disabled by default.
 - In interface configuration mode, run the **spanning-tree autoedge** command to enable Auto Edge on a port and the **spanning-tree autoedge disabled** command to disable it on a port.
- ❖ Configuring Root Guard
 - Root Guard is disabled by default.
 - In interface configuration mode, run the **spanning-tree guard root** command to enable root guard on a port and the **no spanning-tree guard root** command to disable it on a port.
- ❖ Configuring Loop Guard
 - Loop Guard is disabled by default.
 - In global configuration mode, run the **spanning-tree loopguard default** command to enable loop guard on all ports and the **no spanning-tree loopguard default** command to disable it on all ports.

- In interface configuration mode, run the **spanning-tree guard loop** command to enable loop guard on a port and the **no spanning-tree guard loop** command to disable it on a port.
- ❖ **Configuring BPDU Transparent Transmission**
 - BPDU Transparent Transmission is disabled by default.
 - In global configuration mode, run the **bridge-frame forwarding protocol bpdu** command to enable BPDU transparent transmission and the **no bridge-frame forwarding protocol bpdu** command to disable it.
 - BPDU transparent transmission takes effect only when STP is disabled. If STP is enabled on a device, the device does not transparently transmit BPDU packets.
- ❖ **Configuring BPDU Tunnel**
 - BPDU Tunnel is disabled by default.
 - In global configuration mode, run the **l2protocol-tunnel stp** command to globally enable BPDU Tunnel and the **no l2protocol-tunnel stp** command to globally disable it.
 - In interface configuration mode, run the **l2protocol-tunnel stp enable** command to enable BPDU Tunnel on a port and the **no l2protocol-tunnel stp enable** command to disable it on a port.
 - BPDU Tunnel takes effect only when it is enabled in both global configuration mode and interface configuration mode.

10.4 Configuration

Configuration	Description and Command	
Enabling STP	(Mandatory) It is used to enable STP.	
	spanning-tree	Enables STP and configures basic attributes.
	spanning-tree mode	Configures the STP mode.
Configuring STP Compatibility	(Optional) It is used to be compatible with competitor devices.	
	spanning-tree compatible enable	Enables the compatibility mode of a port.
	clear spanning-tree detected-protocols	Performs mandatory version check for BPDUs.
Configuring an MSTP Region	(Optional) It is used to configure an MSTP region.	
	spanning-tree mst configuration	Enters the MST configuration mode.

Configuration	Description and Command	
Enabling Fast RSTP Convergence	(Optional) It is used to configure whether the link type of a port is point-to-point connection.	
	spanning-tree link-type	Configures the link type.
Configuring Priorities	(Optional) It is used to configure the switch priority or port priority.	
	spanning-tree priority	Configures the switch priority.
	spanning-tree port-priority	Configures the port priority.
Configuring the Port Path Cost	(Optional) It is used to configure the path cost of a port or the default path cost calculation method.	
	spanning-tree cost	Configures the port path cost.
	spanning-tree pathcost method	Configures the default path cost calculation method.
Configuring the Maximum Hop Count of a BPDU Packet	(Optional) It is used to configure the maximum hop count of a BPDU packet.	
	spanning-tree max-hops	Configures the maximum hop count of a BPDU packet.
Enabling PortFast-related Features	(Optional) It is used to enable PortFast-related features.	
	spanning-tree portfast	Enables PortFast.
	spanning-tree portfast bpduguard default	Enables BPDU guard on all ports.
	spanning-tree bpduguard enabled	Enables BPDU guard on a port.
	spanning-tree portfast bpdufilter default	Enables BPDU filter on all ports.
Enabling TC-related Features	(Optional) It is used to enable TC-related features.	
	spanning-tree tc-protection	Enables TC protection.
	spanning-tree tc-protection tc-guard	Enables TC guard on all ports.
	spanning-tree tc-guard	Enables TC guard on a port.
	spanning-tree ignore tc	Enables TC filter on a port.
Enabling BPDU Source MAC Address Check	(Optional) It is used to enable BPDU source MAC address check.	
	bpdu src-mac-check	Enables BPDU source MAC address check on a port.
Configuring Auto Edge	(Optional) It is used to configure Auto Edge.	
	spanning-tree autoedge	Enables Auto Edge on a port. This function is enabled by default.

Configuration	Description and Command	
Enabling Guard-related Features	(Optional) It is used to enable port guard features.	
	<code>spanning-tree guard root</code>	Enables root guard on a port.
	<code>spanning-tree loopguard default</code>	Enables loop guard on all ports.
	<code>spanning-tree guard loop</code>	Enables loop guard on a port.
	<code>spanning-tree guard none</code>	Disables the guard feature on a port.
Enabling BPDU Transparent Transmission	(Optional) It is used to enable BPDU transparent transmission	
	<code>bridge-frame forwarding protocol bpdu</code>	Enables BPDU transparent transmission.
Enabling BPDU Tunnel	(Optional) It is used to enable BPDU Tunnel.	
	<code>I2protocol-tunnel stp</code>	Enables BPDU Tunnel globally.
	<code>I2protocol-tunnel stp enable</code>	Enables BPDU Tunnel on a port.
	<code>I2protocol-tunnel stp tunnel-dmac</code>	Configures the transparent transmission address of BPDU Tunnel.

10.4.1 Enabling STP

[Configurati on Effect](#)

- Enable STP globally and configure the basic attributes.
- Configure the STP mode.

[Notes](#)

- STP is disabled by default. Once STP is enabled, the device starts to run STP. The device runs MSTP by default.
- The default STP mode is MSTP mode.
- STP and Transparent Interconnection of Lots of Links (TRILL) of the data center cannot be enabled at the same time.
- STP timer parameters take effect only when the device is selected as the root bridge of the spanning tree. That is, the timer parameters of a non-root bridge should use the timer values of the root bridge.

[Configurati on Steps](#)

- ❖ Enabling STP
- Mandatory.

- Unless otherwise specified, enable STP on each device.

❖ Configuring the STP Mode

- Optional.

According to related 802.1 protocol standards, STP, RSTP, and MSTP are mutually compatible, without any configuration by the administrator. However, some vendors' devices do not work according to 802.1 protocol standards, possibly causing incompatibility. Therefore, Qtech provides a command for the administrator to switch the STP mode to a lower version if other vendors' devices are incompatible with Qtech devices.

Verification

- Display the configuration.

Related Commands

❖ Configuring STP

Command	spanning-tree [forward-time <i>seconds</i> hello-time <i>seconds</i> max-age <i>seconds</i> tx-hold-count <i>numbers</i>]
Parameter Description	<p>forward-time <i>seconds</i>: Indicates the interval when the port status changes. The value ranges from 4 to 30 seconds. The default value is 15 seconds.</p> <p>hello-time <i>seconds</i>: Indicates the interval when a device sends a BPDU packet. The value ranges from 1 to 10 seconds. The default value is 2 seconds.</p> <p>max-age <i>second</i>: Indicates the longest TTL of a BPDU packet. The value ranges from 6 to 40 seconds. The default value is 20 seconds.</p> <p>tx-hold-count <i>numbers</i>: Indicates the maximum number of BPDUs sent per second. The value ranges from 1 to 10. The default value is 3.</p>
Command Mode	Global configuration mode
Usage Guide	<p>The value ranges of forward-time, hello-time, and max-age are related. If one of them is modified, the other two ranges are affected. The three values must meet the following condition:</p> $2 \times (\text{Hello Time} + 1 \text{ second}) \leq \text{Max-Age Time} \leq 2 \times (\text{Forward-Delay Time} - 1 \text{ second})$ <p>Otherwise, the topology may become unstable and the configuration will fail.</p>

❖ Configuring the STP Mode

Command	spanning-tree mode [stp rstp mstp]
Parameter Description	<p>stp: Spanning Tree Protocol (IEEE 802.1d)</p> <p>rstp: Rapid Spanning Tree Protocol (IEEE 802.1w)</p> <p>mstp: Multiple Spanning Tree Protocol (IEEE 802.1s)</p>
Command	Global configuration mode

Mode	
Usage Guide	However, some vendors' devices do not work according to 802.1 protocol standards, possibly causing incompatibility. If other vendors' devices are incompatible with Qtech devices, run this command to switch the STP mode to a lower version.

Configurati on Example

❖ Enabling STP and Configuring Timer Parameters

Scenario Figure 10-20	
Configuratio n Steps	<ul style="list-style-type: none"> ➤ Enable STP and set the STP mode to STP on the devices. ➤ Configure the timer parameters of root bridge DEV A as follows: Hello Time=4s, Max Age=25s, Forward Delay=18s.
DEV A	<p>Step 1: Enable STP and set the STP mode to STP.</p> <pre>Qtech#configure terminal Enter configuration commands, one per line. End with CNTL/Z. Qtech(config)#spanning tree Qtech(config)#spanning tree mode stp</pre> <p>Step 2: Configure the timer parameters of root bridge DEV A.</p> <pre>Qtech(config)#spanning tree hello time 4 Qtech(config)#spanning tree max age 25 Qtech(config)#spanning tree forward time 18</pre>
DEV B	<p>Enable STP and set the STP mode to STP.</p> <pre>Qtech#configure terminal Enter configuration commands, one per line. End with CNTL/Z. Qtech(config)#spanning tree Qtech(config)#spanning tree mode stp</pre>

Verification	➤ Run the show spanning-tree summary command to display the spanning tree topology and protocol configuration parameters.
DEV A	<pre>Qtech#show spanning tree summary Spanning tree enabled protocol stp Root ID Priority 0 Address 08c6.b322.3344 this bridge is root Hello Time 4 sec Forward Delay 18 sec Max Age 25 sec Bridge ID Priority 0 Address 08c6.b322.3344 Hello Time 4 sec Forward Delay 18 sec Max Age 25 sec Interface Role Sts Cost Prio OperEdge Type ----- Gi0/2 Desg FWD 20000 128 False P2p Gi0/1 Desg FWD 20000 128 False P2p</pre>
DEV B	<pre>Qtech#show spanning tree summary Spanning tree enabled protocol stp Root ID Priority 0 Address 08c6.b322.3344 this bridge is root Hello Time 4 sec Forward Delay 18 sec Max Age 25 sec Bridge ID Priority 32768 Address 001a.a917.78cc Hello Time 2 sec Forward Delay 15 sec Max Age 20 sec Interface Role Sts Cost Prio OperEdge Type -----</pre>

Gi0/2	Altn BLK 20000	128	False	P2p Bound(STP)
Gi0/1	Root FWD 20000	128	False	P2p Bound(STP)

Common Errors

N/A

10.4.2 Configuring STP Compatibility

Configuration Effect

- Enable the compatibility mode of a port to realize interconnection between Qtech devices and other SPs' devices.
- Enable protocol migration to perform forcible version check to affect the compatibility between RSTP and STP.

Notes

- If the compatibility mode is enabled on a port, this port will add different MSTI information into the to-be-sent BPDU based on the current port to realize interconnection between Qtech devices and other SPs' devices.
- When enabling compatibility on a port, ensure correct VLAN trimming information of the port. It is recommended to configure consistent VLAN lists for ports at both ends of the link.

Configuration Steps

- ❖ Enabling the Compatibility Mode on a Port
 - Optional.
- ❖ Configuring Protocol Migration
 - ❖ Optional.
 - ❖ If the peer device supports RSTP, you can enforce version check on the local device to force the two devices to run RSTP.

Verification

- Display the configuration.

Related Commands

- ❖ Enabling the Compatibility Mode on a Port

Command	spanning-tree compatible enable
Parameter Description	N/A
Command Mode	Interface configuration mode
Usage Guide	If the compatibility mode is enabled on a port, this port will add different MSTI information into the to-be-sent BPDU based on the current port to realize interconnection between Qtech devices and other SPs' devices.

❖ Enabling Protocol Migration

Command	clear spanning-tree detected-protocols [interface interface-id]
Parameter Description	interface interface-id: Indicates a port.
Command Mode	Privileged EXEC mode
Usage Guide	This command is used to enforce a port to send RSTP BPDU packets and perform forcible check on them.

[Configurati on Example](#)

❖ Enabling STP Compatibility

Scenario Figure 10-21	
Configuratio n Steps	<ul style="list-style-type: none"> ➤ Configure Instances 1 and 2 on Devices A and B, and map Instance 1 with VLAN 10 and Instance 2 with VLAN 20. ➤ Configure Gi0/1 and Gi0/2 to respectively belong to VLAN 10 and VLAN 20, and enable STP compatibility.
DEV A	<p>Step 1: Configure Instances 1 and 2, and map Instances 1 and 2 respectively with VLANs 10 and 20.</p> <pre>Qtech#configure terminal</pre>

	<p>Enter configuration commands, one per line. End with CNTL/Z.</p> <pre>Qtech(config)#spanning tree mst configuration Qtech(config mst)#instance 1 vlan 10 Qtech(config mst)#instance 2 vlan 20</pre> <p>Step 2: Configure the VLAN the port belongs to, and enable STP compatibility on the port.</p> <pre>Qtech(config)#int gi 0/1 Qtech(config if GigabitEthernet 0/1)#switchport access vlan 10 Qtech(config if GigabitEthernet 0/1)#spanning tree compatible enable Qtech(config if GigabitEthernet 0/1)#int gi 0/2 Qtech(config if GigabitEthernet 0/2)#switchport access vlan 20 Qtech(config if GigabitEthernet 0/2)#spanning tree compatible enable</pre>														
DEV B	Perform the same steps as DEV A.														
Verification	➤ Run the show spanning-tree summary command to check whether the spanning tree topology is correctly calculated.														
DEV A	<pre>Qtech#show spanning tree summary</pre> <p>Spanning tree enabled protocol mstp</p> <pre>MST 0 vlans map : 1 9, 11 19, 21 4094 Root ID Priority 32768 Address 001a.a917.78cc this bridge is root Hello Time 2 sec Forward Delay 15 sec Max Age 20 sec Bridge ID Priority 32768 Address 001a.a917.78cc Hello Time 2 sec Forward Delay 15 sec Max Age 20 sec</pre> <table border="1"> <thead> <tr> <th>Interface</th> <th>Role</th> <th>Sts</th> <th>Cost</th> <th>Prio</th> <th>OperEdge</th> <th>Type</th> </tr> </thead> <tbody> <tr> <td>Gi0/2</td> <td>Desg</td> <td>FWD</td> <td>20000</td> <td>128</td> <td>False</td> <td>P2p</td> </tr> </tbody> </table>	Interface	Role	Sts	Cost	Prio	OperEdge	Type	Gi0/2	Desg	FWD	20000	128	False	P2p
Interface	Role	Sts	Cost	Prio	OperEdge	Type									
Gi0/2	Desg	FWD	20000	128	False	P2p									

	<pre> Gi0/1 Desg FWD 20000 128 False P2p MST 1 vlans map : 10 Region Root Priority 32768 Address 001a.a917.78cc this bridge is region root Bridge ID Priority 32768 Address 001a.a917.78cc Interface Role Sts Cost Prio OperEdge Type Gi0/1 Desg FWD 20000 128 False P2p MST 2 vlans map : 20 Region Root Priority 32768 Address 001a.a917.78cc this bridge is region root Bridge ID Priority 32768 Address 001a.a917.78cc Interface Role Sts Cost Prio OperEdge Type Gi0/2 Desg FWD 20000 128 False P2p </pre>
DEV B	<pre> Qtech#show spanning tree summary Spanning tree enabled protocol mstp MST 0 vlans map : 1 9, 11 19, 21 4094 Root ID Priority 32768 Address 001a.a917.78cc this bridge is root </pre>



```

        Hello Time  2 sec  Forward Delay 15 sec  Max Age 20 sec

    Bridge ID  Priority    32768
        Address    08c6.b322.3344
        Hello Time  4 sec  Forward Delay 18 sec  Max Age 25 sec

Interface          Role Sts Cost      Prio   OperEdge Type
-----
Gi0/2              Altn BLK 20000   128    False  P2p
Gi0/1              Root FWD 20000   128    False  P2p

MST 1 vlans map : 10
    Region Root Priority  32768
        Address    001a.a917.78cc
        this bridge is region root

    Bridge ID  Priority    32768
        Address    08c6.b322.3344

Interface          Role Sts Cost      Prio   OperEdge Type
-----
Gi0/1              Root FWD 20000   128    False  P2p

MST 2 vlans map : 20
    Region Root Priority  32768
        Address    001a.a917.78cc
        this bridge is region root

    Bridge ID  Priority    32768
        Address    08c6.b322.3344

Interface          Role Sts Cost      Prio   OperEdge Type
-----
```

	Gi0/2	Root FWD 20000	128	False	P2p
--	-------	----------------	-----	-------	-----

Common Errors

N/A

10.4.3 Configuring an MSTP Region

Configuration Effect

- Configure an MSTP region to adjust which devices belong to the same MSTP region and thereby affect the network topology.

Notes

- To make multiple devices belong to the same MSTP region, configure the same name, revision number, and instance-VLAN mapping table for them.
- You can configure VLANs for Instances 0 to 64, and then the remaining VLANs are automatically allocated to Instance 0. One VLAN belongs to only one instance.
- It is recommended to configure the instance-VLAN mapping table after disabling STP. After the configuration, re-enable MSTP to ensure stability and convergence of the network topology.

Configuration Steps

- ❖ Configuring an MSTP Region
 - Optional.
 - Configure an MSTP region when multiple devices need to belong to the same MSTP region.

Verification

- Display the configuration.

Related Commands

- ❖ Entering MSTP Region Configuration Mode

Command	spanning-tree mst configuration
Parameter	N/A

Description	
Command Mode	Global configuration mode
Usage Guide	Run this command to enter the MST configuration mode.

❖ Configuring Instance-VLAN Mapping

Command	instance <i>instance-id</i> vlan <i>vlan-range</i>
Parameter Description	<i>instance-id</i> : Indicates the MSTI ID, ranging from 0 to 64. <i>vlan-range</i> : Indicates the VLAN ID, ranging from 1 to 4,094.
Command Mode	MST configuration mode
Usage Guide	To add a VLAN group to an MSTI, run this command. For example, instance 1 vlan 2-200: Adds VLANs 2 to 200 to Instance 1. instance 1 vlan 2,20,200: Adds VLANs 2, 20, and 200 to Instance 1. You can use the no form of this command to remove VLANs from an instance. Removed VLANs are automatically forwarded to Instance 0.

❖ Configuring MST Version Name

Command	name <i>name</i>
Parameter Description	<i>name</i> : Indicates the MST name. It consists of a maximum of 32 bytes.
Command Mode	MST configuration mode
Usage Guide	N/A

❖ Configuring MST Version Number

Command	revision <i>version</i>
Parameter Description	<i>version</i> : Indicates the MST revision number, ranging from 0 to 65,535.
Command Mode	MST configuration mode
Usage Guide	N/A

[Configurati on Example](#)

❖ Enabling MSTP to Achieve VLAN Load Balancing in the MSTP+VRRP Topology

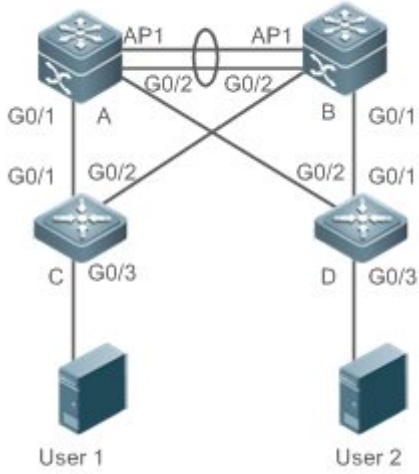
<p>Scenario Figure 10-22</p>	
<p>Configuration Steps</p>	<ul style="list-style-type: none"> ➤ Enable MSTP and create Instances 1 and 2 on Switches A, B, C, and D. ➤ Configure Switch A as the root bridge of Instances 0 and 1 and Switch B as the root bridge of Instance 2. ➤ Configure Switch A as the VRRP master device of VLANs 1 and 10 and Switch B as the VRRP master device of VLAN 20.
<p>A</p>	<p>Step 1: Configure VLANs 10 and 20, and configure ports as Trunk ports.</p> <pre>A(config)#vlan 10 A(config vlan)#vlan 20 A(config vlan)#exit A(config)#int range gi 0/1 2 A(config if range)#switchport mode trunk A(config if range)#int ag 1 A(config if AggregatePort 1)# switchport mode trunk</pre> <p>Step 2: Enable MSTP and create Instances 1 and 2.</p> <pre>A(config)#spanning tree A(config)# spanning tree mst configuration A(config mst)#instance 1 vlan 10 A(config mst)#instance 2 vlan 20 A(config mst)#exit</pre> <p>Step 3: Configure Switch A as the root bridge of Instances 0 and 1.</p> <pre>A(config)#spanning tree mst 0 priority 4096</pre>

```
A(config)#spanning tree mst 1 priority 4096
```

```
A(config)#spanning tree mst 2 priority 8192
```

Step 4: Configure VRRP priorities to enable Switch A to act as the VRRP master device of VLAN 10, and configure the virtual gateway IP address of VRRP.

```
A(config)#interface vlan 10
```

```
A(config if VLAN 10)ip address 192.168.10.2 255.255.255.0
```

```
A(config if VLAN 10) vrrp 1 priority 120
```

```
A(config if VLAN 10) vrrp 1 ip 192.168.10.1
```

Step 5 Set the VRRP priority to the default value 100 to enable Switch A to act as the VRRP backup device of VLAN 20.

```
A(config)#interface vlan 20
```

```
A(config if VLAN 20)ip address 192.168.20.2 255.255.255.0
```

```
A(config if VLAN 20) vrrp 1 ip 192.168.20.1
```

B

Step 1: Configure VLANs 10 and 20, and configure ports as Trunk ports.

```
B(config)#vlan 10
```

```
B(config vlan)#vlan 20
```

```
B(config vlan)#exit
```

```
B(config)#int range gi 0/1 2
```

```
B(config if range)#switchport mode trunk
```

```
B(config if range)#int ag 1
```

```
B(config if AggregatePort 1)# switchport mode trunk
```

Step 2: Enable MSTP and create Instances 1 and 2.

```
B(config)#spanning tree
```

```
B(config)# spanning tree mst configuration
```

```
B(config mst)#instance 1 vlan 10
```

```
B(config mst)#instance 2 vlan 20
```

```
B(config mst)#exit
```

Step 3: Configure Switch A as the root bridge of Instance 2.

```
B(config)#spanning tree mst 0 priority 8192
```

	<pre>B(config)#spanning tree mst 1 priority 8192 B(config)#spanning tree mst 2 priority 4096</pre> <p>Step 4: Configure the virtual gateway IP address of VRRP.</p> <pre>B(config)#interface vlan 10 B(config if VLAN 10)ip address 192.168.10.3 255.255.255.0 B(config if VLAN 10) vrrp 1 ip 192.168.10.1</pre> <p>Step 5 Set the VRRP priority to 120 to enable Switch B to act as the VRRP backup device of VLAN 20.</p> <pre>B(config)#interface vlan 20 B(config if VLAN 20)vrrp 1 priority 120 B(config if VLAN 20)ip address 192.168.20.3 255.255.255.0 B(config if VLAN 20) vrrp 1 ip 192.168.20.1</pre>
C	<p>Step 1: Configure VLANs 10 and 20, and configure ports as Trunk ports.</p> <pre>C(config)#vlan 10 C(config vlan)#vlan 20 C(config vlan)#exit C(config)#int range gi 0/1 2 C(config if range)#switchport mode trunk</pre> <p>Step 2: Enable MSTP and create Instances 1 and 2.</p> <pre>C(config)#spanning tree C(config)# spanning tree mst configuration C(config mst)#instance 1 vlan 10 C(config mst)#instance 2 vlan 20 C(config mst)#exit</pre> <p>Step 3: Configure the port connecting Device C directly to users as a PortFast port and enable BPDU guard.</p> <pre>C(config)#int gi 0/3 C(config if GigabitEthernet 0/3)#spanning tree portfast C(config if GigabitEthernet 0/3)#spanning tree bpduguard enable</pre>
D	<p>Perform the same steps as Device C.</p>

Verification	<ul style="list-style-type: none"> ➤ Run the show spanning-tree summary command to check whether the spanning tree topology is correctly calculated. ➤ Run the show vrrp brief command to check whether the VRRP master/backup devices are successfully created.
A	<pre> Qtech#show spanning tree summary Spanning tree enabled protocol mstp MST 0 vlans map : 1 9, 11 19, 21 4094 Root ID Priority 4096 Address 08c6.b322.3344 this bridge is root Hello Time 4 sec Forward Delay 18 sec Max Age 25 sec Bridge ID Priority 4096 Address 08c6.b322.3344 Hello Time 4 sec Forward Delay 18 sec Max Age 25 sec Interface Role Sts Cost Prio OperEdge Type ----- Ag1 Desg FWD 19000 128 False P2p Gi0/1 Desg FWD 200000 128 False P2p Gi0/2 Desg FWD 200000 128 False P2p MST 1 vlans map : 10 Region Root Priority 4096 Address 08c6.b322.3344 this bridge is region root Bridge ID Priority 4096 Address 08c6.b322.3344 Interface Role Sts Cost Prio OperEdge Type ----- </pre>

	<pre> Ag1 Desg FWD 19000 128 False P2p Gi0/1 Desg FWD 200000 128 False P2p Gi0/2 Desg FWD 200000 128 False P2p MST 2 vlans map : 20 Region Root Priority 4096 Address 001a.a917.78cc this bridge is region root Bridge ID Priority 8192 Address 08c6.b322.3344 Interface Role Sts Cost Prio OperEdge Type Ag1 Root FWD 19000 128 False P2p Gi0/1 Desg FWD 200000 128 False P2p Gi0/2 Desg FWD 200000 128 False P2p </pre>
B	<pre> Qttech#show spanning tree summary Spanning tree enabled protocol mstp MST 0 vlans map : 1 9, 11 19, 21 4094 Root ID Priority 4096 Address 08c6.b322.3344 this bridge is root Hello Time 4 sec Forward Delay 18 sec Max Age 25 sec Bridge ID Priority 8192 Address 001a.a917.78cc Hello Time 2 sec Forward Delay 15 sec Max Age 20 sec Interface Role Sts Cost Prio OperEdge Type </pre>

```

Ag1          Root FWD 19000    128    False   P2p
Gi0/1       Desg FWD 200000    128    False   P2p
Gi0/2       Desg FWD 200000    128    False   P2p

MST 1 vlans map : 10
  Region Root Priority  4096
    Address  08c6.b322.3344
    this bridge is region root

  Bridge ID Priority  8192
    Address  001a.a917.78cc

Interface    Role Sts Cost      Prio    OperEdge Type
Ag1          Root FWD 19000    128    False   P2p
Gi0/1       Desg FWD 200000    128    False   P2p
Gi0/2       Desg FWD 200000    128    False   P2p

MST 2 vlans map : 20
  Region Root Priority  4096
    Address  001a.a917.78cc
    this bridge is region root

  Bridge ID Priority  4096
    Address  001a.a917.78cc

Interface    Role Sts Cost      Prio    OperEdge Type
Ag1          Desg FWD 19000    128    False   P2p
Gi0/1       Desg FWD 200000    128    False   P2p
Gi0/2       Desg FWD 200000    128    False   P2p

```

C

```
Qtech#show spanning tree summary

Spanning tree enabled protocol mstp
MST 0 vlans map : 1 9, 11 19, 21 4094
  Root ID    Priority    4096
            Address    08c6.b322.3344
            this bridge is root
            Hello Time  4 sec Forward Delay 18 sec Max Age 25 sec

  Bridge ID  Priority    32768
            Address    001a.a979.00ea
            Hello Time  2 sec Forward Delay 15 sec Max Age 20 sec

Interface          Role Sts Cost          Prio   Type OperEdge
-----
Fa0/2              Altn BLK 200000    128    P2p   False
Fa0/1              Root FWD 200000    128    P2p   False

MST 1 vlans map : 10
  Region Root Priority    4096
            Address    08c6.b322.3344
            this bridge is region root

  Bridge ID  Priority    32768
            Address    001a.a979.00ea

Interface          Role Sts Cost          Prio   Type OperEdge
-----
Fa0/2              Altn BLK 200000    128    P2p   False
Fa0/1              Root FWD 200000    128    P2p   False

MST 2 vlans map : 20
```

	<pre> Region Root Priority 4096 Address 001a.a917.78cc this bridge is region root Bridge ID Priority 32768 Address 001a.a979.00ea </pre>
	<pre> Interface Role Sts Cost Prio Type OperEdge ----- Fa0/2 Root FWD 200000 128 P2p False Fa0/1 Altn BLK 200000 128 P2p False </pre>
D	Omitted.

Common Errors

- MST region configurations are inconsistent in the MSTP topology.
- VLANs are not created before you configure the mapping between the instance and VLAN.
- A device runs STP or RSTP in the MSTP+VRRP topology, but calculates the spanning tree according to the algorithms of different MST regions.

10.4.4 Enabling Fast RSTP Convergence

Configuration Effect

- Configure the link type to make RSTP rapidly converge.

Notes

- If the link type of a port is point-to-point connection, RSTP can rapidly converge. For details, see "Fast RSTP Convergence". If the link type is not configured, the device automatically sets the link type based on the duplex mode of the port. If a port is in full duplex mode, the device sets the link type to point-to-point. If a port is in half duplex mode, the device sets the link type to shared. You can also forcibly configure the link type to determine whether the port connection is point-to-point connection.
- The link type of a port is related to the rate and duplex mode. If the port is in half duplex mode, the link type is shared.

Configurati on Steps

❖ Configuring the Link Type

- Optional.

Verification

- Display the configuration.
- Run the **show spanning-tree [mst instance-id] interface interface-id** command to display the spanning tree configuration of the port.

Related Commands

❖ Configuring the Link Type

Command	spanning-tree link-type [point-to-point shared]
Parameter Description	point-to-point: Forcibly configures the link type of a port to be point-to-point. shared: Forcibly configures the link type of a port to be shared.
Command Mode	Interface configuration mode
Usage Guide	If the link type of a port is point-to-point connection, RSTP can rapidly converge. If the link type is not configured, the device automatically sets the link type based on the duplex mode of the port.

Configurati on Example

❖ Enabling Fast RSTP Convergence

Configuratio n Steps	Set the link type of a port to point-to-point.
	<pre>Qtech(config)#int gi 0/1 Qtech(config if GigabitEthernet 0/1)#spanning tree link type point to point</pre>
Verification	<ul style="list-style-type: none"> ● Run the show spanning-tree summary command to display the link type of the port.
	<pre>Qtech#show spanning tree summary Spanning tree enabled protocol mstp MST 0 vlans map : ALL Root ID Priority 32768</pre>

Address		001a.a917.78cc			
this bridge is root					
Hello Time		2 sec	Forward Delay		15 sec Max Age 20 sec
Bridge ID		Priority	32768		
Address		08c6.b322.3344			
Hello Time		2 sec	Forward Delay		15 sec Max Age 20 sec
Interface	Role	Sts	Cost	Prio	OperEdge Type
Gi0/1	Root	FWD	20000	128	False P2p

Common Errors

N/A

10.4.5 Configuring Priorities

Configuration Effect

- Configure the switch priority to determine a device as the root of the entire network and to determine the topology of the entire network.
- Configure the port priority to determine which port enters the forwarding state.

Notes

- It is recommended to set the priority of the core device higher (to a smaller value) to ensure stability of the entire network. You can assign different switch priorities to different instances so that each instance runs an independent STP based on the assigned priorities. Devices in different regions use the priority only of the CIST (Instance 0). As described in bridge ID, the switch priority has 16 optional values: 0, 4,096, 8,192, 12,288, 16,384, 20,480, 24,576, 28,672, 32,768, 36,864, 40,960, 45,056, 49,152, 53,248, 57,344, 61,440. They are integral multiples of 4,096. The default value is 32,768.
- If two ports are connected to a shared device, the device selects a port with a higher priority (smaller value) to enter the forwarding state and a port with a lower priority (larger value) to enter the discarding state. If the two ports have the same priority, the device selects the port with a smaller port ID to enter the forwarding state. You can assign different port priorities to different instances on a port so that each instance runs an independent STP based on the assigned priorities.

- Similar to the switch priority, the port priority also has 16 optional values: 0, 16, 32, 48, 64, 80, 96, 112, 128, 144, 160, 176, 192, 208, 224, 240. They are integral multiples of 16. The default value is 128.
- The modified port priority takes effect only on the designated port.

Configurati on Steps

- ❖ Configuring the Switch Priority
 - Optional.
 - To change the root or topology of a network, configure the switch priority.
- ❖ Configuring the Port Priority
 - Optional.
 - To change the preferred port entering the forwarding state, configure the port priority.

Verification

- Display the configuration.
- Run the **show spanning-tree [mst instance-id] interface interface-id** command to display the spanning tree configuration of the port.

Related

Commands

- ❖ Configuring the Switch Priority

Command	spanning-tree [mst instance-id] priority priority
Parameter	mst instance-id : Indicates the instance ID, ranging from 0 to 64.
Description	priority priority : Indicates the switch priority. There are 16 optional values: 0, 4,096, 8,192, 12,288, 16,384, 20,480, 24,576, 28,672, 32,768, 36,864, 40,960, 45,056, 49,152, 53,248, 57,344, 61,440. They are integral multiples of 4,096.
Command Mode	Global configuration mode
Usage Guide	Configure the switch priority to determine a device as the root of the entire network and to determine the topology of the entire network.

- ❖ Configuring the Port Priority

Command	spanning-tree [mst instance-id] port-priority priority
Parameter	mst instance-id : Indicates the instance ID, ranging from 0 to 64.
Description	port-priority priority : Indicates the port priority. There are 16 optional values: 0, 16, 32, 48, 64, 80, 96,

	112, 128, 144, 160, 176, 192, 208, 224, 240. They are integral multiples of 4,096.
Command Mode	Interface configuration mode
Usage Guide	If a loop occurs in a region, the port with a higher priority is preferred to enter the forwarding state. If two ports have the same priority, the port with a smaller port ID is selected to enter the forwarding state. Run this command to determine which port in the loop of a region enters the forwarding state.

Configuration on Example

❖ Configuring the Port Priority

Scenario Figure 10-23	
Configuration Steps	<ul style="list-style-type: none"> Configure the bridge priority so that DEV A becomes the root bridge of the spanning tree. Configure the priority of Gi0/2 on DEV A is 16 so that Gi0/2 on DEV B can be selected as the root port.
DEV A	<p>Step 1: Enable STP and configure the bridge priority.</p> <pre>Qtech(config)#spanning tree Qtech(config)#spanning tree mst 0 priority 0</pre> <p>Step 2: Configure the priority of Gi 0/2.</p> <pre>Qtech(config)# int gi 0/2 Qtech(config if GigabitEthernet 0/2)#spanning tree mst 0 port priority 16</pre>
DEV B	<pre>Qtech(config)#spanning tree</pre>
Verification	<ul style="list-style-type: none"> Run the show spanning-tree summary command to display the topology calculation result of the spanning tree.
DEV A	<pre>Qtech# Qtech#show spanning tree summary</pre>

	<pre>Spanning tree enabled protocol mstp MST 0 vlans map : ALL Root ID Priority 0 Address 08c6.b322.3344 this bridge is root Hello Time 2 sec Forward Delay 15 sec Max Age 20 sec Bridge ID Priority 0 Address 08c6.b322.3344 Hello Time 2 sec Forward Delay 15 sec Max Age 20 sec Interface Role Sts Cost Prio OperEdge Type ----- Gi0/2 Desg FWD 20000 16 False P2p Gi0/1 Desg FWD 20000 128 False P2p</pre>
DEV B	<pre>Qtech#show spanning tree summary Spanning tree enabled protocol mstp MST 0 vlans map : ALL Root ID Priority 0 Address 08c6.b322.3344 this bridge is root Hello Time 2 sec Forward Delay 15 sec Max Age 20 sec Bridge ID Priority 32768 Address 001a.a917.78cc Hello Time 2 sec Forward Delay 15 sec Max Age 20 sec Interface Role Sts Cost Prio OperEdge Type ----- Gi0/2 Root FWD 20000 128 False P2p</pre>

Gi0/1	Altn BLK 20000	128	False	P2p
-------	----------------	-----	-------	-----

Common Errors

N/A

10.4.6 Configuring the Port Path Cost

Configuration Effect

- Configure the path cost of a port to determine the forwarding state of the port and the topology of the entire network.
- If the path cost of a port uses its default value, configure the path cost calculation method to affect the calculation result.

Notes

- A device selects a port as the root port if the path cost from this port to the root bridge is the lowest. Therefore, the port path cost determines the root port of the local device. The default port path cost is automatically calculated based on the port rate (Media Speed). A port with a higher rate will have a low path cost. Since this method can calculate the most scientific path cost, do not change the path cost unless required. You can assign different path costs to different instances on a port so that each instance runs an independent STP based on the assigned path costs.
- If the port path cost uses the default value, the device automatically calculates the port path cost based on the port rate. However, IEEE 802.1d-1998 and IEEE 802.1t define different path costs for the same link rate. The value is a short integer ranging from 1 to 65,535 in 802.1d-1998 while is a long integer ranging from 1 to 200,000,000 in IEEE 802.1t. The path cost of an aggregate port (AP) has two solutions: 1. Qtech solution: Port Path Cost x 95%; 2. Solution recommended in standards: 20,000,000,000/Actual link bandwidth of the AP, in which Actual link bandwidth of the AP = Bandwidth of a member port x Number of active member ports. The administrator must unify the path cost calculation method in the entire network. The default standard is the private long integer standard.
- The following table lists path costs automatically configured for different link rate in two solutions.

Port Rate	Port	IEEE 802.1d (short)	IEEE 802.1t (long)	IEEE 802.1t (long standard)
10M	Common port	100	2000000	2000000
	AP	95	1900000	2000000+linkupcnt
100M	Common port	19	200000	200000

Port Rate	Port	IEEE 802.1d (short)	IEEE 802.1t (long)	IEEE 802.1t (long standard)
	AP	18	190000	200000÷linkupcnt
1000M	Common port	4	20000	20000
	AP	3	19000	20000÷linkupcnt
10000M	Common port	2	2000	2000
	AP	1	1900	20000÷linkupcnt

- Qtech's long integer standard is used by default. After the solution is changed to the path cost solution recommended by the standards, the path cost of an AP changes with the number of member ports in UP state. If the port path cost changes, the network topology also will change.
- If an AP is static, linkupcnt in the table is the number of active member ports. If an AP is an LACP AP, linkupcnt in the table is the number of member ports forwarding AP data. If no member port in the AP goes up, linkupcnt is 1. For details about AP and LACP, see the *Configuring AP*.
- The modified port path cost takes effect only on the Rx port.

Configurati on Steps

❖ Configuring the Port Path Cost

- Optional.
- To determine which port or path data packets prefer to pass through, configure the port path cost.

❖ Configuring the Default Path Cost Calculation Method

- Optional.
- To change the path cost calculation method, configure the default path cost calculation method.

Verification

- Display the configuration.
- Run the **show spanning-tree [mst instance-id] interface interface-id** command to display the spanning tree configuration of the port.

Related Commands

- ❖ Configuring the Port Path Cost

Command	spanning-tree [mst instance-id] cost cost
Parameter Description	mst instance-id: Indicates the instance ID, ranging from 0 to 64. cost cost: Indicates the path cost, ranging from 1 to 200,000,000.
Command Mode	Interface configuration mode
Usage Guide	A larger value of <i>cost</i> indicates a higher path cost.

❖ Configuring the Default Path Cost Calculation Method

Command	spanning-tree pathcost method { long [standard] short }
Parameter Description	<i>long:</i> Uses the path cost specified in 802.1t. <i>standard:</i> Uses the cost calculated according to the standard. <i>short:</i> Uses the path cost specified in 802.1d.
Command Mode	Global configuration mode
Usage Guide	If the port path cost uses the default value, the device automatically calculates the port path cost based on the port rate.

[Configurations on Example](#)

❖ Configuring the Port Path Cost

Scenario Figure 10-24	
Configuration Steps	<ul style="list-style-type: none"> Configure the bridge priority so that DEV A becomes the root bridge of the spanning tree. Configure the path cost of Gi 0/2 on DEV B is 1 so that Gi 0/2 can be selected as the root port.
DEV A	<pre>Qtech(config)#spanning tree Qtech(config)#spanning tree mst 0 priority 0</pre>
DEV B	<pre>Qtech(config)#spanning tree</pre>

	<pre>Qtech(config)# int gi 0/2 Qtech(config if GigabitEthernet 0/2)# spanning tree cost 1</pre>
Verification	<ul style="list-style-type: none"> Run the show spanning-tree summary command to display the topology calculation result of the spanning tree.
DEV A	<pre>Qtech# Qtech#show spanning tree summary Spanning tree enabled protocol mstp MST 0 vlans map : ALL Root ID Priority 0 Address 08c6.b322.3344 this bridge is root Hello Time 2 sec Forward Delay 15 sec Max Age 20 sec Bridge ID Priority 0 Address 08c6.b322.3344 Hello Time 2 sec Forward Delay 15 sec Max Age 20 sec Interface Role Sts Cost Prio OperEdge Type ----- Gi0/2 Desg FWD 20000 128 False P2p Gi0/1 Desg FWD 20000 128 False P2p</pre>
DEV B	<pre>Qtech#show spanning tree summary Spanning tree enabled protocol mstp MST 0 vlans map : ALL Root ID Priority 0 Address 08c6.b322.3344 this bridge is root Hello Time 2 sec Forward Delay 15 sec Max Age 20 sec Bridge ID Priority 32768 Address 001a.a917.78cc</pre>

Hello Time 2 sec Forward Delay 15 sec Max Age 20 sec						
Interface	Role	Sts	Cost	Prio	OperEdge	Type
Gi0/2	Root	FWD	1	128	False	P2p
Gi0/1	Altn	BLK	20000	128	False	P2p

Common Errors

- N/A

10.4.7 Configuring the Maximum Hop Count of a BPDU Packet

Configuration Effect

- Configure the maximum hop count of a BPDU packet to change the BPDU TTL and thereby affect the network topology.

Notes

- The default maximum hop count of a BPDU packet is 20. Generally, it is not recommended to change the default value.

Configuration Steps

- ❖ Configuring the Maximum Hop Count
- (Optional) If the network topology is so large that a BPDU packet exceeds the default 20 hops, it is recommended to change the maximum hop count.

Verification

- Display the configuration.

Related Commands

- ❖ Configuring the Maximum Hop Count

Command	<code>spanning-tree max-hops hop-count</code>
Parameter Description	<i>hop-count</i> : Indicates the number of devices a BPDU passes through before being discarded. It ranges from 1 to 40.
Command Mode	Global configuration mode

Usage Guide	<p>In a region, the BPDU sent by the root bridge includes a hop count. Every time a BPDU passes through a device from the root bridge, the hop count decreases by 1. When the hop count becomes 0, the BPDU times out and the device discards the packet.</p> <p>This command specifies the number of devices a BPDU passes through in a region before being discarded. Changing the maximum hop count will affect all instances.</p>
--------------------	---

Configurati on Example

❖ Configuring the Maximum Hop Count of a BPDU Packet

Configuratio n Steps	<ul style="list-style-type: none"> ● Set the maximum hop count of a BPDU packet to 25.
	<pre>Qtech(config)# spanning tree max hops 25</pre>
Verification	<ul style="list-style-type: none"> ● Run the show spanning-tree command to display the configuration.
	<pre>Qtech# show spanning tree StpVersion : MSTP SysStpStatus : ENABLED MaxAge : 20 HelloTime : 2 ForwardDelay : 15 BridgeMaxAge : 20 BridgeHelloTime : 2 BridgeForwardDelay : 15 MaxHops: 25 TxHoldCount : 3 PathCostMethod : Long BPDUGuard : Disabled BPDUFilter : Disabled LoopGuardDef : Disabled ##### mst 0 vlans map : ALL BridgeAddr : 08c6.b322.3344 Priority: 0 TimeSinceTopologyChange : 2d:0h:46m:4s TopologyChanges : 25</pre>

```
DesignatedRoot : 0.001a.a917.78cc
RootCost : 0
RootPort : GigabitEthernet 0/1
CistRegionRoot : 0.001a.a917.78cc
CistPathCost : 20000
```

10.4.8 Enabling PortFast-related Features

Configurati on Effect

- After PortFast is enabled on a port, the port directly enters the forwarding state. However, since the Port Fast Operational State becomes disabled due to receipt of BPDUs, the port can properly run the STP algorithm and enter the forwarding state.
- If BPDU guard is enabled on a port, the port enters the error-disabled state after receiving a BPDU.
- If BPDU filter is enabled on a port, the port neither sends nor receives BPDUs.

Notes

- The global BPDU guard takes effect only when PortFast is enabled on a port.
- If BPDU filter is enabled globally, a PortFast-enabled port neither sends nor receives BPDUs. In this case, the host connecting directly to the PortFast-enabled port does not receive any BPDUs. If the port changes its Port Fast Operational State to Disabled after receiving a BPDU, BPDU filter automatically fails.
- The global BPDU filter takes effect only when PortFast is enabled on a port.

Configurati on Steps

- ❖ Enabling PortFast
 - Optional.
 - If a port connects directly to the network terminal, configure this port as a PortFast port.

- ❖ Enabling BPDU Guard
 - Optional.

- If device ports connect directly to network terminals, you can enable BPDU guard on these ports to prevent BPDU attacks from causing abnormality in the spanning tree topology. A port enabled with BPDU guard enters the error-disabled state after receiving a BPDU.
- If device ports connect directly to network terminals, you can enable BPDU guard to prevent loops on the ports. The prerequisite is that the downlink device (such as the hub) can forward BPDU packets.

❖ Enabling BPDU Filter

- Optional.
- To prevent abnormal BPDU packets from affecting the spanning tree topology, you can enable BPDU filter on a port to filter abnormal BPDU packets.

Verification

- Display the configuration.
- Run the **show spanning-tree [mst instance-id] interface interface-id** command to display the spanning tree configuration of the port.

Related

Commands

❖ Configuring PortFast

Command	spanning-tree portfast
Parameter Description	N/A
Command Mode	Interface configuration mode
Usage Guide	After PortFast is enabled on a port, the port directly enters the forwarding state. However, since the Port Fast Operational State becomes disabled due to receipt of BPDUs, the port can properly run the STP algorithm and enter the forwarding state.

❖ Configuring BPDU Guard for all Ports

Command	spanning-tree portfast bpduguard default
Parameter Description	N/A
Command	Global configuration mode



Mode	
Usage Guide	If BPDU guard is enabled on a port, the port enters the error-disabled state after receiving a BPDU. Run the show spanning-tree command to display the configuration.

❖ Configuring BPDU Guard for a Port

Command	spanning-tree bpduguard enabled
Parameter	N/A
Description	
Command Mode	Interface configuration mode
Usage Guide	If BPDU guard is enabled on a port, the port enters the error-disabled state after receiving a BPDU.

❖ Configuring BPDU Filter for all Ports

Command	spanning-tree portfast bpdupfilter default
Parameter	N/A
Description	
Command Mode	Global configuration mode
Usage Guide	If BPDU filter is enabled, corresponding ports neither send nor receive BPDUs.

❖ Configuring BPDU Filter for a Port

Command	spanning-tree bpdupfilter enabled
Parameter	N/A
Description	
Command Mode	Interface configuration mode
Usage Guide	If BPDU filter is enabled on a port, the port neither sends nor receives BPDUs.

Configurati on Example

❖ Enabling PortFast on a Port

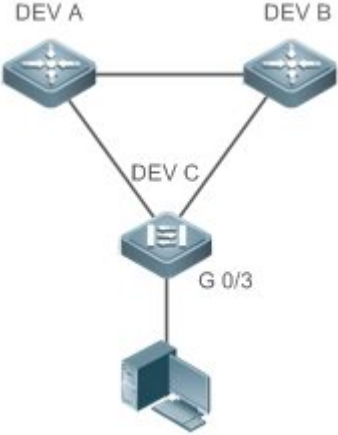

<p>Scenario Figure 10-25</p>	
<p>Configuration Steps</p>	<ul style="list-style-type: none"> ● Configure Gi 0/3 of DEV C as a PortFast port and enable BPDU guard.
<p>DEV C</p>	<pre>Qtech(config)# int gi 0/3 Qtech(config-if GigabitEthernet 0/3)# spanning tree portfast %Warning: portfast should only be enabled on ports connected to a single host. Connecting hubs, switches, bridges to this interface when portfast is enabled, can cause temporary loops. Qtech(config-if GigabitEthernet 0/3)#spanning tree bpduguard enable</pre>
<p>Verification</p>	<ul style="list-style-type: none"> ● Run the show spanning-tree interface command to display the port configuration.
<p>DEV C</p>	<pre>Qtech#show spanning tree int gi 0/3 PortAdminPortFast : Enabled PortOperPortFast : Enabled PortAdminAutoEdge : Enabled PortOperAutoEdge : Enabled PortAdminLinkType : auto PortOperLinkType : point to point PortBPDUGuard : Enabled PortBPDUFilter : Disabled PortGuardmode : None</pre>

```
##### MST 0 vlans mapped :ALL
PortState : forwarding
PortPriority : 128
PortDesignatedRoot : 0.08c6.b322.3344
PortDesignatedCost : 0
PortDesignatedBridge :0.08c6.b322.3344
PortDesignatedPortPriority : 128
PortDesignatedPort : 4
PortForwardTransitions : 1
PortAdminPathCost : 20000
PortOperPathCost : 20000
Inconsistent states : normal
PortRole : designatedPort
```

10.4.9 Enabling TC-related Features

Configurati on Effect

- If TC protection is enabled on a port, the port deletes TC BPDU packets within a specified time (generally 4 seconds) after receiving them, preventing MAC and ARP entry from being removed.
- If TC guard is enabled, a port receiving TC packets filters TC packets received or generated by itself so that TC packets are not spread to other ports. In this way, possible TC attacks are efficiently prevented to keep the network stable.
- TC filter does not process TC packets received by ports but processes TC packets in case of normal topology changes.

Notes

- It is recommended to enable TC guard only when illegal TC attack packets are received in the network.

Configurati on Steps

- ❖ Enabling TC Protection
- Optional.

- TC protection is disabled by default.

- ❖ Enabling TC Guard
 - Optional.
 - TC guard is disabled by default.
 - To filter TC packets received or generated due to topology changes, you can enable TC guard.

- ❖ Enabling TC Filter
 - Optional.
 - TC filter is disabled by default.
 - To filter TC packets received on a port, you can enable TC filter on the port.

Verification

- Display the configuration.

Related Commands

❖ Enabling TC Protection

Command	<code>spanning-tree tc-protection</code>
Parameter Description	N/A
Command Mode	Global configuration mode
Usage Guide	N/A

❖ Configuring TC Guard for all Ports

Command	<code>spanning-tree tc-protection tc-guard</code>
Parameter Description	N/A
Command Mode	Global configuration mode
Usage Guide	Enable TC guard to prevent TC packets from spreading.

❖ Configuring TC Guard for a Port

Command	spanning-tree tc-guard
Parameter Description	N/A
Command Mode	Interface configuration mode
Usage Guide	Enable TC guard to prevent TC packets from spreading.

❖ Configuring TC Filter for a Port

Command	spanning-tree ignore tc
Parameter Description	N/A
Command Mode	Interface configuration mode
Usage Guide	If TC filter is enabled on a port, the port does not process received TC packets.

Configurati on Example

❖ Enabling TC Guard on a Port

Configuration Steps	Enable TC guard on a port.
	<pre>Qtech(config)#int gi 0/1 Qtech(config-if GigabitEthernet 0/1)#spanning tree tc guard</pre>
Verification	<ul style="list-style-type: none"> Run the show run interface command to display the TC guard configuration of the port.
	<pre>Qtech#show run int gi 0/1 Building configuration... Current configuration : 134 bytes interface GigabitEthernet 0/1 switchport mode trunk spanning tree tc guard</pre>

Common Errors

- If TC guard or TC filter is incorrectly configured, an error may occur during packet forwarding of the network device. For example, when the topology changes, the device fails to clear MAC address in a timely manner, causing packet forwarding errors.

10.4.10 Enabling BPDU Source MAC Address Check

Configuration Effect

- Enable BPDU source MAC address check. After this, a device receives only BPDU packets with the source MAC address being the specified MAC address and discards other BPDU packets.

Notes

- When the switch connected to a port on a point-to-point link is determined, you can enable BPDU source MAC address check so that the switch receives the BPDU packets sent only by the peer switch.

Configuration Steps

- ❖ Enabling BPDU Source MAC Address Check
 - Optional.
 - BPDU source MAC address check is disabled by default.
 - To prevent malicious BPDU attacks, you can enable BPDU source MAC address check.

Verification

- Display the configuration.

Related Commands

- ❖ Enabling BPDU Source MAC Address Check

Command	<code>bpdu src-mac-check H.H.H</code>
Parameter Description	<i>H.H.H</i> : Indicates an MAC address. The device receives only BPDU packets with this address being the source MAC address.
Command Mode	Interface configuration mode
Usage Guide	BPDU source MAC address check prevents BPDU packets from maliciously attacking switches and causing MSTP abnormal. When the switch connected to a port on a point-to-point link is determined, you

can enable BPDU source MAC address check to receive BPDU packets sent only by the peer switch and discard all other BPDU packets, thereby preventing malicious attacks.

You can enable BPDU source MAC address check in interface configuration mode for a specific port.

One port can only filter one MAC address.

Configuration Example

❖ Enabling BPDU Source MAC Address Check on a Port

Configuration Steps	Enable BPDU source MAC address check on a port.
	<pre>Qtech(config)#int gi 0/1 Qtech(config-if GigabitEthernet 0/1)#bpdu src mac check 08c6.b300.1234</pre>
Verification	<ul style="list-style-type: none"> Run the show run interface command to display the spanning tree configuration of the port.
	<pre>Qtech#show run int gi 0/1 Building configuration... Current configuration : 170 bytes interface GigabitEthernet 0/1 switchport mode trunk bpdu src mac check 08c6.b300.1234 spanning tree link type point to point</pre>

Common Errors

- If BPDU source MAC address check is enabled on a port, the port receives only BPDU packets with the configured MAC address being the source MAC address and discards all other BPDU packets.



10.4.11 Configuring Auto Edge

Configurati on Effect

- Enable Auto Edge. If a designated port does not receive any BPDUs within a specified time (3 seconds), it is automatically identified as an edge port. However, if the port receives BPDUs, its Port Fast Operational State will become Disabled.

Notes

- Unless otherwise specified, do not disable Auto Edge.
- By default, the port is automatically identified as an edge port and enters the forwarding state if a designated port does not receive any BPDUs within 3 seconds. If packet loss or packet Tx/Rx delay occurs in the network, it is recommended to disable Auto Edge.

Configurati on Steps

- ❖ Configuring Auto Edge
- Optional.
- Auto Edge is enabled by default.

Verification

- Display the configuration.

Related Commands

- ❖ Configuring Auto Edge

Command	<code>spanning-tree autoedge</code>
Parameter	N/A
Description	
Command Mode	Interface configuration mode
Usage Guide	<p>If the designated port of a device does not receive a BPDU from the downlink port within a specific period (3 seconds), the device regards a network device connected to the designated port, configures the port as an edge port, and switches the port directly into the forwarding state. The edge port will be automatically identified as a non-edge port after receiving a BPDU.</p> <p>You can run the <code>spanning-tree autoedge disabled</code> command to disable Auto Edge.</p>

Configuration Example

❖ Disabling Auto Edge on a Port

Configuration Steps	Disable Auto Edge on a port.
	<pre>Qtech(config)#int gi 0/1 Qtech(config-if GigabitEthernet 0/1)#spanning tree autoedge disabled</pre>
Verification	<ul style="list-style-type: none"> ● Run the show spanning-tree interface command to display the spanning tree configuration of the port.
	<pre>Qtech#show spanning tree interface gi 0/1 PortAdminPortFast : Disabled PortOperPortFast : Disabled PortAdminAutoEdge : Disabled PortOperAutoEdge : Disabled PortAdminLinkType : point to point PortOperLinkType : point to point PortBPDUGuard : Disabled PortBPDUFilter : Disabled PortGuardmode : None ##### MST 0 vlans mapped :ALL PortState : forwarding PortPriority : 128 PortDesignatedRoot : 0.08c6.b322.3344 PortDesignatedCost : 0 PortDesignatedBridge :0.08c6.b322.3344 PortDesignatedPortPriority : 128 PortDesignatedPort : 2 PortForwardTransitions : 6 PortAdminPathCost : 20000</pre>

```
PortOperPathCost : 20000
Inconsistent states : normal
PortRole : designatedPort
```

Common Errors

10.4.12 Enabling Guard-related Features

Configuration Effect

- If root guard is enabled on a port, its roles on all instances are enforced as the designated port. Once the port receives configuration information with a higher priority, it enters the root-inconsistent (blocking) state. If the port does not receive configuration information with a higher priority within a period, it returns to its original state.
- Due to the unidirectional link failure, the root port or backup port becomes the designated port and enters the forwarding state if it does not receive BPDUs, causing a network loop. Loop guard is to prevent this problem.

Notes

- Root guard and loop guard cannot take effect on a port at the same time.

Configuration Steps

❖ Enabling Root Guard

- Optional.
- The root bridge may receive configuration with a higher priority due to incorrect configuration by maintenance personnel or malicious attacks in the network. As a result, the current root bridge may lose its role, causing incorrect topology changes. To prevent this problem, you can enable root guard on a designated port of a device.

❖ Enabling Loop Guard

- Optional.
- You can enable loop guard on a port (root port, master port, or AP) to prevent it from failing to receive BPDUs sent by the designated bridge, increasing device stability. Otherwise, the network topology will change, possibly causing a loop.

❖ Disabling Guard

- Optional.
- Guard is disabled by default.

Verification

- Display the configuration.

RelatedCommands

❖ Enabling Root Guard

Command	spanning-tree guard root
Parameter	N/A
Description	
Command Mode	Interface configuration mode
Usage Guide	If root guard is enabled, the current root bridge will not change due to incorrect configuration or illegal packet attacks.

❖ Enabling Loop Guard of all Ports

Command	spanning-tree loopguard default
Parameter	N/A
Description	
Command Mode	Global configuration mode
Usage Guide	Enabling loop guard on a root port or backup port will prevent possible loops caused by BPDU receipt failure.

❖ Enabling Loop Guard of a Port

Command	spanning-tree guard loop
Parameter	N/A
Description	
Command Mode	Interface configuration mode
Usage Guide	Enabling loop guard on a root port or backup port will prevent possible loops caused by BPDU receipt failure.

❖ Disabling Guard

Command	spanning-tree guard none
Parameter	N/A

Description	
Command Mode	Interface configuration mode
Usage Guide	N/A

Configurati on Example

❖ Enabling Loop Guard on a Port

Scenario Figure 10-26	
Configuratio n Steps	<ul style="list-style-type: none"> Configure DEV A as the root bridge and DEV B as a non-root bridge on a spanning tree. Enable loop guard on ports Gi 0/1 and Gi 0/2 of DEV B.
DEV A	<pre>Qtech(config)#spanning tree Qtech(config)#spanning tree mst 0 priority 0</pre>
DEV B	<pre>Qtech(config)#spanning tree Qtech(config)# int range gi 0/1 2 Qtech(config if range)#spanning tree guard loop</pre>
Verification	<ul style="list-style-type: none"> Run the show spanning-tree interface command to display the spanning tree configuration of the port.
DEV A	Omitted.
DEV B	<pre>Qtech#show spanning tree int gi 0/1 PortAdminPortFast : Disabled PortOperPortFast : Disabled</pre>

```
PortAdminAutoEdge : Enabled
PortOperAutoEdge : Disabled
PortAdminLinkType : auto
PortOperLinkType : point to point
PortBPDUGuard : Disabled
PortBPDUFilter : Disabled
PortGuardmode : Guard loop

##### MST 0 vlans mapped :ALL
PortState : forwarding
PortPriority : 128
PortDesignatedRoot : 0.001a.a917.78cc
PortDesignatedCost : 0
PortDesignatedBridge :0.001a.a917.78cc
PortDesignatedPortPriority : 128
PortDesignatedPort : 17
PortForwardTransitions : 1
PortAdminPathCost : 20000
PortOperPathCost : 20000
Inconsistent states : normal
PortRole : rootPort

Qtech#show spanning tree int gi 0/2

PortAdminPortFast : Disabled
PortOperPortFast : Disabled
PortAdminAutoEdge : Enabled
PortOperAutoEdge : Disabled
PortAdminLinkType : auto
PortOperLinkType : point to point
PortBPDUGuard : Disabled
PortBPDUFilter : Disabled
PortGuardmode : Guard loop
```

```
##### MST 0 vlans mapped :ALL
PortState : discarding
PortPriority : 128
PortDesignatedRoot : 0.001a.a917.78cc
PortDesignatedCost : 0
PortDesignatedBridge :0.001a.a917.78cc
PortDesignatedPortPriority : 128
PortDesignatedPort : 18
PortForwardTransitions : 1
PortAdminPathCost : 20000
PortOperPathCost : 20000
Inconsistent states : normal
PortRole : alternatePort
```

Common Errors

- If root guard is enabled on the root port, master port, or AP, the port may be incorrectly blocked.

10.4.13 Enabling BPDU Transparent Transmission

Configuration Effect

- If STP is disabled on a device, the device needs to transparently transmit BPDU packets so that the spanning tree between devices is properly calculated.

Notes

- BPDU transparent transmission takes effect only when STP is disabled. If STP is enabled on a device, the device does not transparently transmit BPDU packets.

Configuration Steps

- ❖ Enabling BPDU Transparent Transmission
- Optional.
- If STP is disabled on a device that needs to transparently transmit BPDU packets, enable BPDU transparent transmission.

Verification

- Display the configuration.

Related Commands

❖ Enabling BPDU Transparent Transmission

Command	bridge-frame forwarding protocol bpdu
Parameter Description	N/A
Command Mode	Global configuration mode
Usage Guide	In IEEE 802.1Q, the destination MAC address 01-80-C2-00-00-00 of the BPDU is used as a reserved address. That is, devices compliant with IEEE 802.1Q do not forward the BPDU packets received. However, devices may need to transparently transmit BPDU packets in actual network deployment. For example, if STP is disabled on a device, the device needs to transparently transmit BPDU packets so that the spanning tree between devices is properly calculated. BPDU transparent transmission takes effect only when STP is disabled. If STP is enabled on a device, the device does not transparently transmit BPDU packets.

Configuration Example

❖ Enabling BPDU Transparent Transmission

Scenario Figure 10-27	<pre> graph LR A[DEV A] --- B[DEV B] B --- C[DEV C] subgraph STP_Status A --- STP_A[STP] B --- STP_B[] C --- STP_C[STP] end </pre>
	STP is enabled on DEV A and DEV C while is disabled on DEV B.
Configuration Steps	<ul style="list-style-type: none"> ● Enable BPDU transparent transmission on DEV B so that STP between DEV A and DEV C can be correctly calculated.
DEV B	<pre>Qtech(config)#bridge frame forwarding protocol bpdu</pre>
Verification	<ul style="list-style-type: none"> ● Run the show run command to check whether BPDU transparent transmission is enabled.
DEV B	<pre>Qtech#show run</pre>

```
Building configuration...
Current configuration : 694 bytes
bridge frame forwarding protocol bpdu
```

10.4.14 Enabling BPDU Tunnel

Configurati on Effect

- Enable BPDU Tunnel so that STP packets from the customer network can be transparently transmitted across the SP network. STP packet transmission between the customer network does not affect the SP network, causing STP on the customer network to be calculated independently of that on the SP network.

Notes

- BPDU Tunnel takes effect only when it is enabled in both global configuration mode and interface configuration mode.

Configurati on Steps

- ❖ Enabling BPDU Tunnel
- (Optional) In a QinQ network, you can enable BPDU Tunnel if STP needs to be calculated separately between customer networks and SP networks.

Verification

- Run the **show l2protocol-tunnel stp** command to display the BPDU Tunnel configuration.

Related Commands

- ❖ Configuring BPDU Tunnel in Global Configuration Mode

Command	l2protocol-tunnel stp
Parameter	N/A
Description	
Command Mode	Global configuration mode
Usage Guide	BPDU Tunnel takes effect only when it is enabled in both global configuration mode and interface

	configuration mode.
--	---------------------

❖ Configuring BPDU Tunnel in Interface Configuration Mode

Command	<code>l2protocol-tunnel stp enable</code>
Parameter Description	N/A
Command Mode	Interface configuration mode
Usage Guide	BPDU Tunnel takes effect only when it is enabled in both global configuration mode and interface configuration mode.

❖ Configuring BPDU Tunnel Transparent Transmission Address

Command	<code>l2protocol-tunnel stp tunnel-dmac mac-address</code>
Parameter Description	<i>mac-address</i> : Indicates the STP address for transparent transmission.
Command Mode	Global configuration mode
Usage Guide	<p>If an STP packet sent from a customer network enters a PE, the PE changes the destination MAC address of the packet to a private address before the packet is forwarded by the SP network. When the packet reaches the PE at the peer end, the PE changes the destination MAC address to a public address and returns the packet to the customer network at the peer end, realizing transparent transmission across the SP network. This private address is the transparent transmission address of BPDU Tunnel.</p> <hr/> <p>Optional transparent transmission addresses of STP packets include 08c6.b300.0005, 011a.a900.0005, 010f.e200.0003, 0100.0ccd.cdd0, 0100.0ccd.cdd1, and 0100.0ccd.cdd2.</p> <p>If no transparent transmission address is configured, BPDU Tunnel uses the default address 08c6.b300.0005.</p>

[Configurati on Example](#)

❖ Enabling BPDU Tunnel

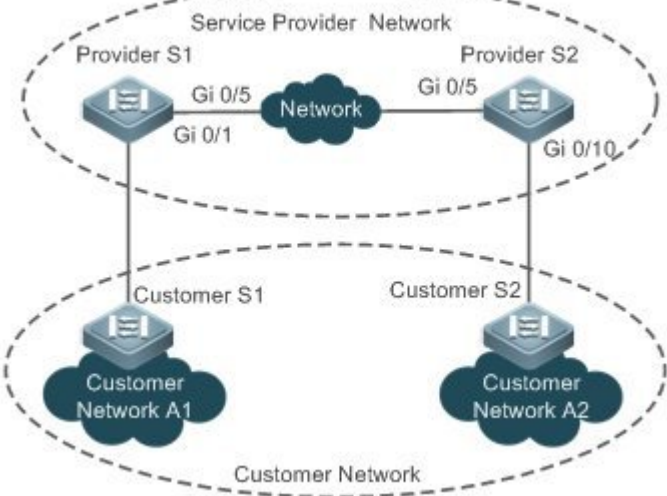
<p>Scenario Figure 10-28</p>	
<p>Configuration Steps</p>	<ul style="list-style-type: none"> ➤ Enable basic QinQ on the PEs (Provider S1/Provider S2 in this example) so that data packets of the customer network are transmitted within VLAN 200 on the SP network. ➤ Enable STP transparent transmission on the PEs (Provider S1/Provider S2 in this example) so that the SP network can transmit STP packets of the customer network through BPDU Tunnel.
<p>Provider S1</p>	<p>Step 1: Create VLAN 200 on the SP network.</p> <pre>Qtech#configure terminal Enter configuration commands, one per line. End with CNTL/Z. Qtech(config)#vlan 200 Qtech(config vlan)#exit</pre> <p>Step 2: Enable basic QinQ on the port connected to the customer network and use VLAN 20 for tunneling.</p> <pre>Qtech(config)#interface gigabitEthernet 0/1 Qtech(config if GigabitEthernet 0/1)#switchport mode dot1q tunnel Qtech(config if GigabitEthernet 0/1)#switchport dot1q tunnel native vlan 200 Qtech(config if GigabitEthernet 0/1)#switchport dot1q tunnel allowed vlan add untagged 200</pre> <p>Step 3: Enable STP transparent transmission on the port connected to the customer network.</p> <pre>Qtech(config if GigabitEthernet 0/1)#l2protocol tunnel stp enable Qtech(config if GigabitEthernet 0/1)#exit</pre>

	<p>Step 4: Enable STP transparent transmission in global configuration mode.</p> <pre>Qtech(config)#l2protocol tunnel stp</pre> <p>Step 5: Configure an Uplink port.</p> <pre>Qtech(config)# interface gigabitEthernet 0/5 Qtech(config if GigabitEthernet 0/5)#switchport mode uplink</pre>
Provider S2	Configure Provider S2 by performing the same steps.
Verification	<ul style="list-style-type: none"> ➤ Check whether the BPDU Tunnel configuration is correct. ➤ Verify the Tunnel port configuration by checking whether: 1. The port type is dot1q-tunnel; 2. The outer tag VLAN is consistent with the native VLAN and added to the VLAN list of the Tunnel port; 3. The port that accesses the SP network is configured as an Uplink port.
Provider S1	<p>Step 1: Check whether the BPDU Tunnel configuration is correct.</p> <pre>Qtech#show l2protocol tunnel stp</pre> <pre>L2protocol tunnel: stp Enable L2protocol tunnel destination mac address: 08c6.b300.0005 GigabitEthernet 0/1 l2protocol tunnel stp enable</pre> <p>Step 2: Check whether the QinQ configuration is correct.</p> <pre>Qtech#show running config interface GigabitEthernet 0/1 switchport mode dot1q tunnel switchport dot1q tunnel allowed vlan add untagged 200 switchport dot1q tunnel native vlan 200 l2protocol tunnel stp enable spanning tree bpdufilter enable ! interface GigabitEthernet 0/5 switchport mode uplink</pre>
Provider S2	Verify Provider S2 configuration by performing the same steps.

Common Errors

- In the SP network, BPDU packets can be correctly transparently transmitted only when the transparent transmission addresses of BPDU Tunnel are consistent.

10.5 Monitoring

Clearing

Running the **clear** commands may lose vital information and thus interrupt services.

Description	Command
Clears the statistics of packets sent and received on a port.	clear spanning-tree counters [interface <i>interface-id</i>]
Clears the STP topology change information.	clear spanning-tree mst <i>instance-id</i> topochange record

Displaying

Description	Command
Displays MSTP parameters and spanning tree topology information.	show spanning-tree
Displays the count of sent and received MSTP packets.	show spanning-tree counters [interface <i>interface-id</i>]
Displays MSTP instances and corresponding port forwarding status.	show spanning-tree summary
Displays the ports that are blocked by root guard or loop guard.	show spanning-tree inconsistentports
Displays the configuration of an MST region.	show spanning-tree mst configuration
Displays MSTP information of an instance.	show spanning-tree mst <i>instance-id</i>
Displays MSTP information of the instance corresponding to a port.	show spanning-tree mst <i>instance-id</i> interface <i>interface-id</i>
Displays topology changes of a port in an instance.	show spanning-tree mst <i>instance-id</i> topochange record
Displays MSTP information of all instances corresponding to a port.	show spanning-tree interface <i>interface-id</i>
Displays the forwarding time.	show spanning-tree forward-time
Displays the hello time.	show spanning-tree hello time
Displays the maximum hop count.	show spanning-tree max-hops
Displays the maximum number of BPDU packets sent per second.	show spanning-tree tx-hold-count
Displays the path cost calculation method.	show spanning-tree pathcost method
Displays BPDU Tunnel information.	show l2protocol-tunnel stp

Debugging

System resources are occupied when debugging information is output. Therefore, disable the debugging switch immediately after use.

Description	Command
Debugs all STPs.	debug mstp all
Debugs MSTP Graceful Restart (GR).	debug mstp gr
Debugs BPDU packet receiving.	debug mstp rx
Debugs BPDU packet sending.	debug mstp tx
Debugs MSTP events.	debug mstp event
Debugs loop guard.	debug mstp loopguard
Debugs root guard.	debug mstp rootguard
Debugs the bridge detection state machine.	debug mstp bridgedetect
Debugs the port information state machine.	debug mstp portinfo
Debugs the port protocol migration state machine.	debug mstp protomigrat
Debugs MSTP topology changes.	debug mstp topochange
Debugs the MSTP receiving state machine.	debug mstp receive
Debugs the port role transition state machine.	debug mstp roletran
Debugs the port state transition state machine.	debug mstp statetran
Debugs the MSTP sending state machine.	debug mstp transmit

11. CONFIGURING GVRP

11.1 Overview

The GARP VLAN Registration Protocol (GVRP) is an application of the Generic Attribute Registration Protocol (GARP) used to dynamically configure and proliferate VLAN memberships.

GVRP simplifies VLAN configuration and management. It reduces the workload of manually configuring VLANs and adding ports to VLANs, and reduces the possibility of network disconnection due to inconsistent configuration. With GVRP, you can dynamically maintain VLANs and add/remove ports to/from VLANs to ensure VLAN connectivity in a topology.

Protocols and Standards

IEEE standard 802.1D

IEEE standard 802.1Q

11.2 Applications

Application	Description
GVRP Configuration in a LAN	Connect two switches in a local area network (LAN) and realize VLAN synchronization.
GVRP PDUs Tunnel Application	Use the GVRP Protocol Data Units (PDUs) Tunnel feature to transparently transmit GVRP packets through a tunnel in a QinQ network environment.

11.2.1 GVRP Configuration in a LAN

Scenario

Enable GVRP and set the GVRP registration mode to Normal to register and deregister all dynamic and static VLANs between Device A and Device F.

Figure 11-1

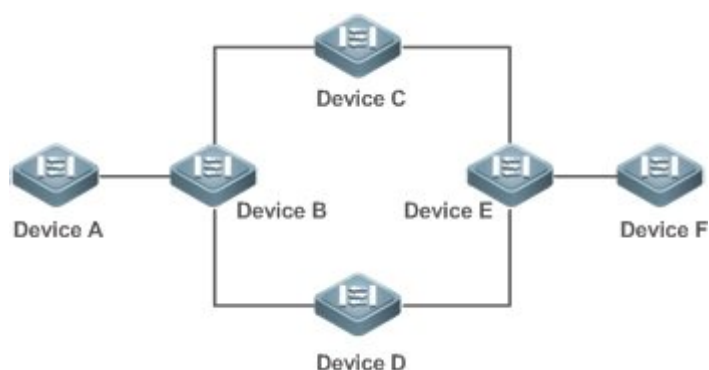

Remark	Device A, Device B, Device C, Device D, Device E, and Device F are switches. The ports connected between two devices are Trunk ports. On Device A and Device F, configure static VLANs used for communication. Enable GVRP on all switches.
---------------	---

Deployment

t

- On each device, enable the GVRP and dynamic VLAN creation features, and ensure that dynamic VLANs can be created on intermediate devices.
- On Device A and Device F, configure static VLANs used for communication. Device B, Device C, Device D, and Device E will dynamically learn the VLANs through GVRP.

It is recommended that the Spanning Tree Protocol (STP) be enabled to avoid loops in the customer network topology.

11.2.2 GVRP PDUs Tunnel Application

Scenario

A QinQ network environment is generally divided into a customer network and a service provider (SP) network. The GVRP PDUs Tunnel feature allows GVRP packets to be transmitted between customer networks without impact on SP networks. The GVRP calculation in customer networks is separated from that in SP networks without interference.

Figure 11-2 GVRP PDUs Tunnel Application Topology

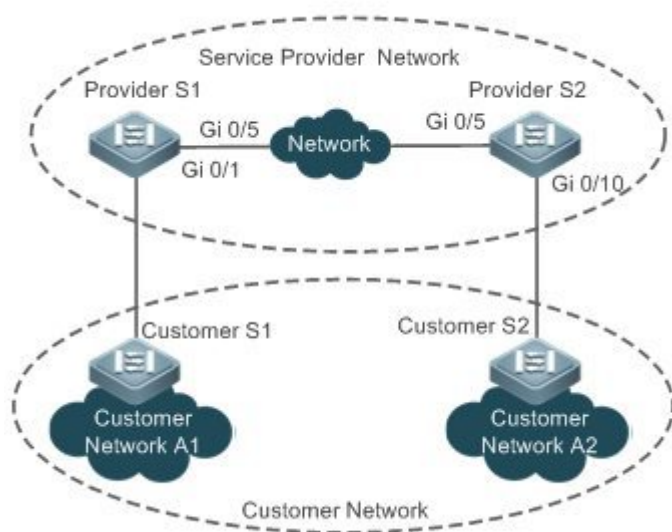

Remark	Figure 11-2 shows an SP network and a customer network. The SP network contains the provider edge (PE) devices Provider S1 and Provider S2. Customer Network A1 and Customer Network A2 are the same customer's two sites in different locations. Customer S1 and Customer S2 are the access devices in the customer network, which are connected to the SP network through Provider S1 and Provider S2 respectively. The GVRP PDUs Tunnel feature allows Customer Network A1 and Customer Network A2 to perform unified GVRP calculation across the SP network, without impact on the SP network's GVRP calculation.
---------------	---

Deployment

t

- Enable basic QinQ on the PEs (Provider S1 and Provider S2) in the SP network to transmit data packets from the customer network through a specified VLAN in the SP network.
- Enable GVRP transparent transmission on the PEs (Provider S1 and Provider S2) in the SP network to allow the SP network to tunnel GVRP packets from the customer network via the GVRP PDUs Tunnel feature.

11.3 Features

Basic Concepts

❖ GVRP

GVRP is an application of GARP used to register and deregister VLAN attributes in the following modes:

- When a port receives a VLAN attribute declaration, the port will register the VLAN attributes contained in the declaration (that is, the port will join the VLAN).

- When a port receives a VLAN attribute revocation declaration, the port will deregister the VLAN attributes contained in the declaration (that is, the port will exit the VLAN).

Figure 11-3

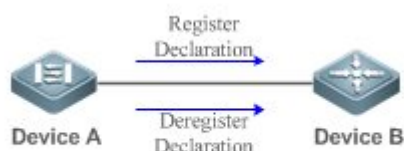

❖ Dynamic VLAN

A VLAN that can be dynamically created and deleted without the need for manual configuration is called a dynamic VLAN.

You can manually convert a dynamic VLAN to a static VLAN, but not the way around.

A protocol state machine controls the joining of ports to dynamic VLANs created through GVRP. Only the Trunk ports that receive GVRP VLAN attribute declaration can join these VLANs. You cannot manually add ports to dynamic VLANs.

❖ Message Types

(1) Join message

When a GARP application entity hopes other GARP entities to register its attributes, it will send a Join message. When a GARP entity receives a Join message from another entity or requires other entities to register its static attributes, it will send a Join message. There are two types of Join message: JoinEmpty and JoinIn.

- JoinEmpty message: Used to declare an unregistered attribute
- JoinIn message: Used to declare a registered attribute

(2) Leave message

When a GARP application entity hopes other GARP entities to deregister its attributes, it will send a Leave message. When a GARP entity receives a Leave message from another entity or requires other entities to deregister its statically deregistered attributes, it will send a Leave message. There are two types of Leave message: LeaveEmpty and LeaveIn.

- LeaveEmpty message: Used to deregister an unregistered attribute
- LeaveIn message: Used to deregister a registered attribute

(3) LeaveAll message

Each GARP application entity starts its LeaveAll timer during startup. When the timer times out, the entity sends a LeaveAll message to deregister all attributes to enable other GARP entities to

reregister attributes. When the GARP application entity receives a LeaveAll message from another entity, it also sends a LeaveAll message. The LeaveAll timer is restarted when a LeaveAll message is sent again to initiate a new cycle.

❖ Timer Types

GARP defines four timers used to control GARP message sending.

(1) Hold timer

The Hold timer controls the sending of GARP messages (including Join and Leave messages). When a GARP application entity has its attributes changed or receives a GARP message from another entity, it starts the Hold timer. During the timeout period, the GARP application entity encapsulates all GARP messages to be sent into packets as few as possible, and sends the packets when the timer times out. This reduces the quantity of sent packets and saves bandwidth resources.

(2) Join timer

The Join timer controls the sending of Join messages. After a GARP application entity sends a Join message, it waits for one timeout interval of the Join timer to ensure that the Join message is reliably transmitted to another entity. If the GARP application entity receives a JoinIn message from another entity before the timer times out, it will not resend the Join message; otherwise, it will resend the Join message. Not each attribute has its own Join timer, but each GARP application entity has one Join timer.

(3) Leave timer

The Leave timer controls attribute deregistration. When a GARP application entity hopes other entities to deregister one of its attributes, it sends a Leave message. Other entities which receive the Leave message start the Leave timer. The attribute will be deregistered only if these entities receive no Join message mapped to the attribute during the timeout period.

(4) LeaveAll timer

Each GARP application entity starts its own LeaveAll timer upon startup. When the timer times out, the entity sends a LeaveAll message to enable other entities to reregister attributes. Then the LeaveAll timer is restarted to initiate a new cycle.

❖ GVRP Advertising Modes

GVRP allows a switch to inform other interconnected devices of its VLANs and instruct the peer device to create specific VLANs and add the ports that transmit GVRP packets to corresponding VLANs.

Two GVRP advertising modes are available:

- Normal mode: A device externally advertises its VLAN information, including dynamic and static VLANs.

- Non-applicant mode: A device does not externally advertise its VLAN information.

❖ GVRP Registration Modes

A GVRP registration mode specifies whether the switch that receives a GVRP packet processes the VLAN information in the packet, such as dynamically creating a new VLAN and adding the port that receives the packet to the VLAN.

Two GVRP registration modes are available:

- Normal mode: Process the VLAN information in the received GVRP packet.
- Disabled mode: No to process the VLAN information in the received GVRP packet.

Overview

Feature	Description
Intra-Topology VLAN Information Synchronization	Dynamically creates VLANs and adds/removes ports to/from VLANs, which reduces the manual configuration workload and the probability of VLAN disconnection due to missing configuration.

11.3.1 Intra-Topology VLAN Information Synchronization

Working Principle

GVRP is an application of GARP based on the GARP working mechanism. GVRP maintains the dynamic registration information of VLANs on a device and propagates the information to other devices. A GVRP-enabled device receives VLAN registration information from other devices and dynamically updates the local VLAN registration information. The device also propagates the local VLAN registration information to other devices so that all devices in a LAN maintain consistent VLAN information. The VLAN registration information propagated by GVRP includes the manually-configured static registration information on the local device and the dynamic registration information from other devices.

❖ External VLAN Information Advertising

The Trunk port on a GVRP-enabled device periodically collects VLAN information within the port, including the VLANs that the Trunk port joins or exits. The collected VLAN information is encapsulated in a GVRP packet to be sent to the peer device. After the Trunk port on the peer device receives the packet, it resolves the VLAN information. Then corresponding VLANs will be dynamically created, and the Trunk port will join the created VLANs or exit other VLANs. For details about the VLAN information, see the above description of GVRP message types.

Related Configurations

- GVRP is disabled by default.

- Run [no] gvrp enable to enable or disable GVRP.
- After GVRP is enabled on a device, the device sends GVRP packets carrying VLAN information. If GVRP is disabled on the device, the device does not send GVRP packets carrying VLAN information or process received GVRP packets.

❖ VLAN Registration and Deregistration

Upon receiving a GVRP packet, the switch determines whether to process the VLAN information in the packet according to the registration mode of the corresponding port. For details, see the above description of GVRP registration modes.

Related Configurations

- If GVRP is enabled, the port in Trunk mode is enabled with dynamic VLAN registration by default.
- To enable dynamic VLAN registration on a port, run the **gvrp registration mode normal** command. To disable dynamic VLAN registration on a port, run the **gvrp register mode disable** command.

11.4 If dynamic VLAN registration is enabled, dynamic VLANs will be created on the local device when the port receives a GVRP packet carrying VLAN information from the peer end. If dynamic VLAN registration is disabled, no dynamic VLAN will be created on the local device when the port receives a GVRP packet from the peer end.

Configuration

Configuration	Description and Command	
Configuring Basic GVRP Features and VLAN Information Synchronization	(Mandatory) It is used to enable GVRP and dynamic VLAN creation.	
	gvrp enable	Enables GVRP.
	gvrp dynamic-vlan-creation enable	Enables dynamic VLAN creation.
	switchport mode trunk	Switches to Trunk port mode. GVRP take effects only in Trunk mode.
	switchport trunk allowed vlan all	Allows the traffic from all VLANs to pass through.

Configuration	Description and Command	
	gvrp applicant state	Configures the advertising mode of a port. The Normal mode indicates to advertise VLAN information externally by sending a GVRP packet. The Non-applicant mode indicates not to advertise VLAN information externally.
	gvrp registration mode	Configures the registration mode of a port. The Normal mode indicates to process the VLAN information in the received GVRP packet, such as dynamically creating VLANs and adding ports to VLANs. The Disabled mode indicates not to process the VLAN information in the received GVRP packet.
	(Optional) It is used to configure timers and the registration mode and advertising mode of a port.	
	gvrp timer	Configures timers.
Configuring GVRP PDUs Transparent Transmission	(Optional) It is used to configure GVRP PDUs transparent transmission.	
	bridge-frame forwarding protocol gvrp	Enables GVRP PDUs transparent transmission.
Configuring the GVRP PDUs Tunnel Feature	(Optional) It is used to configure the GVRP PDUs Tunnel feature.	
	I2protocol-tunnel gvrp	Enables the GVRP PDUs Tunnel feature in global configuration mode.
	I2protocol-tunnel gvrp enable	Enables the GVRP PDUs Tunnel feature in interface configuration mode.
	I2protocol-tunnel gvrp tunnel-dmac	Configures the transparent transmission address used by the GVRP PDUs Tunnel feature.

11.4.1 Configuring Basic GVRP Features and VLAN Information Synchronization

Configuration Effect

- Dynamically create/delete VLANs and add/remove ports to/from VLANs.
- Synchronize VLAN information between devices to ensure normal intra-topology communication.
- Reduce the manual configuration workload and simplify VLAN management.

Notes

- GVRP must be enabled on both connected devices. GVRP information is transmitted only by Trunk Links. The transmitted information contains the information of all VLANs on the current device, including dynamically learned VLANs and manually configured VLANs.
- If STP is enabled, only ports in Forwarding state participate in GVRP (such as receiving and sending GVRP PDUs) and have their VLAN information propagated by GVRP.
- All VLAN ports added by GVRP are tagged ports.
- The system does not save the VLAN information that is dynamically learned by GVRP. The information will be lost when the device is reset and cannot be saved manually.
- All devices that need to exchange GVRP information must maintain consistent GVRP timers (Join timer, Leave timer, and Leaveall timer).
- If STP is not enabled, all available ports can participate in GVRP. If Single Spanning Tree (SST) is enabled, only ports in Forwarding state in the SST Context participate in GVRP. If Multi Spanning Tree (MST) is enabled, GVRP can run in the Spanning Tree Context to which VLAN1 belongs. You cannot specify other Spanning Tree Context for GVRP.

Configuration Steps

❖ Enabling GVRP

- Mandatory.
- Only GVRP-enabled devices can process GVRP packets.

❖ Enabling Dynamic VLAN Creation

- Mandatory.
- After dynamic VLAN creation is enabled on a device, the device will dynamically create VLANs upon receiving GVRP Join messages.

❖ Configuring Timers

- Optional.
- There are three GVRP timers: Join timer, Leave timer, and Leaveall timer, which are used to control message sending intervals.

- The timer interval relationships are as follows: The interval of the Leave timer must be three times or more greater than that of the Join timer; the interval of the Leaveall timer must be greater than that of the Leave timer.
- The three timers are controlled by the GVRP state machine and can be triggered by each other.
- ❖ Configuring the Advertising Mode of a Port
 - Optional.
 - Two GVRP advertising modes are available: Normal (default) and Non-applicant.
 - Normal mode: Indicates that a device externally advertises its VLAN information.
 - Non-applicant mode: Indicates that a device does not externally advertise its VLAN information.
- ❖ Configuring the Registration Mode of a Port
 - Optional.
 - Two GVRP registration modes are available: Normal and Disabled.

- ❖ Switching to Trunk Port Mode
 - Mandatory.
 - GVRP takes effect only on ports in Trunk mode.

Verification

- Run the **show gvrp configuration** command to check the configuration.
- Check whether a dynamic VLAN is configured and the corresponding port joins the VLAN.

Related

Commands

- ❖ Enabling GVRP

Command	<code>gvrp enable</code>
Parameter Description	N/A
Command Mode	Global configuration mode
Usage Guide	GVRP can be enabled only in global configuration mode. If GVRP is not enabled globally, you can still set other GVRP parameters, but the parameter settings take effect only when GVRP starts running.

❖ Enabling Dynamic VLAN Creation

Command	gvrp dynamic-vlan-creation enable
Parameter Description	N/A
Command Mode	Global configuration mode
Usage Guide	When a port receives a JoinIn or JoinEmpty message that indicates a non-existent VLAN on the local device, GVRP may create this VLAN, depending on the configuration of this command.

➤ The parameters of a dynamic VLAN created through GVRP cannot be modified manually.

❖ Configuring Timers

Command	gvrp timer { join timer-value leave timer-value leaveall timer-value }
Parameter Description	<i>timer-value</i> : 1–2,147,483,647 ms
Command Mode	Global configuration mode
Usage Guide	<p>The interval of the Leave timer must be three times or more greater than that of the Join timer. The interval of the Leaveall timer must be greater than that of the Leave timer. The time unit is milliseconds. The following timer intervals are recommended in actual networking: Join timer: 6,000 ms (6s) Leave timer: 30,000 ms (30s) Leaveall timer: 120,000 ms (2 minutes)</p> <p>➤ Ensure that the GVRP timer settings on all interconnected GVRP devices are consistent; otherwise, GVRP may work abnormally.</p>

❖ Configuring the Advertising Mode of a Port

Command	gvrp applicant state { normal non-applicant }
Parameter Description	normal: Indicates that a port externally advertises VLAN information. non-applicant: Indicates that a port does not externally advertise VLAN information.
Command Mode	Interface configuration mode
Usage Guide	This command is used to configure the GVRP advertising mode of a port.

❖ Configuring the Registration Mode of a Port

Command	gvrp registration mode { normal disabled }
Parameter Description	normal: Indicates that the port is allowed to join a dynamic VLAN. disabled: Indicates that the port is not allowed to join a dynamic VLAN.
Command	Interface configuration mode

Mode	
Usage Guide	This command is used to configure the GVRP registration mode of a port.

Configuration Example

- ❖ Enabling GVRP in a Topology and Dynamically Maintaining VLANs and the VLAN-Port Relationship

Scenario Figure 11-4	
Configuration Steps	<ul style="list-style-type: none"> ➤ On Switch A and Switch C, configure VLANs used for communication in the customer network. ➤ Enable the GVRP and dynamic VLAN creation features on Switch A, Switch B, and Switch C. ➤ Configure the ports connected between switches as Trunk ports, and ensure that the VLAN lists of Trunk ports include the communication VLANs. By default, a Trunk port allows the traffic from all VLANs to pass through. ➤ It is recommended that STP be enabled to avoid loops.
A	<ol style="list-style-type: none"> Create VLAN 1–200 used for communication in the customer network. <pre>A# configure terminal Enter configuration commands, one per line. End with CNTL/Z. A(config)# vlan range 1 200</pre> Enable the GVRP and dynamic VLAN creation features. <pre>A(config)# gvrp enable A(config)# gvrp dynamic vlan creation enable</pre> Configure the port connected to Switch B as a Trunk port. By default, a Trunk port allows the traffic from all VLANs to pass through. <pre>A(config)# interface gigabitEthernet 0/1 A(config if GigabitEthernet 0/1)# switchport mode trunk</pre> Configure the advertising mode and registration mode of the Trunk port. The Normal mode is used by default and does not need to be configured manually. <pre>A(config if GigabitEthernet 0/1)# gvrp applicant state normal A(config if GigabitEthernet 0/1)# gvrp registration mode normal A(config if GigabitEthernet 0/1)# end</pre>

C	➤ The configuration on Switch C is the same as that on Switch A.						
B	<p>1. Enable the GVRP and dynamic VLAN creation features.</p> <pre>B# configure terminal B(config)# gvrp enable B(config)# gvrp dynamic-vlan-creation enable</pre> <p>2. Configure the ports connected to Switch A and Switch C as Trunk ports.</p> <pre>B(config)# interface range GigabitEthernet 0/2-3 B(config-if-GigabitEthernet 0/2)# switchport mode trunk</pre>						
Verification	Check whether the GVRP configuration on each device is correct. Check whether VLAN 2–100 are dynamically created on Switch B and whether Port G 0/2 and Port G 0/3 on Switch B join the dynamic VLANs.						
A	<pre>A# show gvrp configuration Global GVRP Configuration: GVRP Feature:enabled GVRP dynamic VLAN creation:enabled Join Timers(ms):200 Leave Timers(ms):600 Leaveall Timers(ms):1000 Port based GVRP Configuration:</pre> <table border="1" data-bbox="319 1299 1457 1556"> <thead> <tr> <th>PORT</th> <th>Applicant Status</th> <th>Registration Mode</th> </tr> </thead> <tbody> <tr> <td>GigabitEthernet 0/1</td> <td>normal</td> <td>normal</td> </tr> </tbody> </table>	PORT	Applicant Status	Registration Mode	GigabitEthernet 0/1	normal	normal
PORT	Applicant Status	Registration Mode					
GigabitEthernet 0/1	normal	normal					
B	<pre>B# show gvrp configuration Global GVRP Configuration: GVRP Feature:enabled GVRP dynamic VLAN creation:enabled Join Timers(ms):200 Leave Timers(ms):600 Leaveall Timers(ms):1000 Port based GVRP Configuration:</pre>						

	PORT	Applicant Status	Registration Mode
	GigabitEthernet 0/2	normal	normal
	GigabitEthernet 0/3	normal	normal
C	<pre> C# show gvrp configuration Global GVRP Configuration: GVRP Feature:enabled GVRP dynamic VLAN creation:enabled Join Timers(ms):200 Leave Timers(ms):600 Leaveall Timers(ms):1000 Port based GVRP Configuration: PORT Applicant Status Registration Mode GigabitEthernet 0/1 normal normal </pre>		

Common Errors

- The ports connected between devices are not in Trunk mode.
- The VLAN lists of the ports connected between devices do not include the VLANs used for communication in the customer network.
- The GVRP advertising modes and registration modes of Trunk ports are not set to Normal.

11.4.2 Enabling GVRP PDUs Transparent Transmission

Configuration on Effect

Enable devices to transparently transmit GVRP PDU frames to realize normal inter-device GVRP calculation when GVRP is not enabled.

Notes

GVRP PDUs transparent transmission takes effect only when GVRP is disabled. After GVRP is enabled, devices will not transparently transmit GVRP PDU frames.

Configurati on Steps

Configuring GVRP PDUs Transparent Transmission

- Optional.
- Perform this configuration when you need to enable devices to transparently transmit GVRP PDU frames when GVRP is disabled.

Verification

Run the **show run** command to check whether GVRP PDUs transparent transmission is enabled.

Related Commands

Configuring GVRP PDUs Transparent Transmission

Command	<code>bridge-frame forwarding protocol gvrp</code>
Parameter Description	N/A
Command Mode	Global configuration mode
Usage Guide	In the IEEE 802.1Q standard, the destination MAC address 01-80-C2-00-00-06 for GVRP PDUs is reserved. Devices compliant with IEEE 802.1Q do not forward received GVRP PDU frames. However, in actual network deployment, devices may need to transparently transmit GVRP PDU frames to realize normal inter-device GVRP calculation when GVRP is not enabled. GVRP PDUs transparent transmission takes effect only when GVRP is disabled. After GVRP is enabled, devices will not transparently transmit GVRP PDU frames.

Configurati on Example

Configuring GVRP PDUs Transparent Transmission

Scenario Figure 11-5	
	Enable GVRP on DEV A and DEV C. (DEV B is not enabled with GVRP.)
Configuration	Configure GVRP PDUs transparent transmission on DEV B to realize normal GVRP calculation between DEV A and DEV C.

Steps	
DEV B	<pre>Qtech(config)#bridge frame forwarding protocol gvrp</pre>
Verification	Run the show run command to check whether GVRP PDUs transparent transmission is enabled.
DEV B	<pre>Qtech#show run Building configuration... Current configuration : 694 bytes bridge frame forwarding protocol gvrp</pre>

11.4.3 Configuring the GVRP PDUs Tunnel Feature

[Configurati on Effect](#)

Transparently transmit GVRP packets between customer networks through tunnels in SP networks without impact on the SP networks, and thereby separate the GVRP calculation in customer networks from that in SP networks.

[Notes](#)

The GVRP PDUs Tunnel feature takes effect after it is enabled in global configuration mode and interface configuration mode.

[Configurati on Steps](#)

- ❖ Configuring the GVRP PDUs Tunnel Feature
- (Optional) Perform this configuration when you need to separate GVRP calculation between customer networks and SP networks in a QinQ environment.

[Verification](#)

Run the **show l2protocol-tunnel gvrp** command to check the GVRP PDUs Tunnel configuration.

Related Commands

❖ Configuring the GVRP PDUs Tunnel Feature in Global Configuration Mode

Command	I2protocol-tunnel gvrp
Parameter Description	N/A
Command Mode	Global configuration mode
Usage Guide	The GVRP PDUs Tunnel feature takes effect after it is enabled in global configuration mode and interface configuration mode.

❖ Configuring the GVRP PDUs Tunnel Feature in Interface Configuration Mode

Command	I2protocol-tunnel gvrp enable
Parameter Description	N/A
Command Mode	Interface configuration mode
Usage Guide	The GVRP PDUs Tunnel feature takes effect after it is enabled in global configuration mode and interface configuration mode.

❖ Configuring the GVRP PDUs Tunnel Transparent Transmission Address

Command	I2protocol-tunnel gvrp tunnel-dmac <i>mac-address</i>
Parameter Description	<i>mac-address</i> : Indicates the GVRP address used by transparent transmission.
Defaults	The default address is 08c6.b300.0006.
Command Mode	Global configuration mode
Usage Guide	<p>In GVRP PDUs Tunnel application, when a GVRP packet from a customer network enters the PE in an SP network, the destination MAC address of the packet is changed to a private address before the packet is forwarded in the SP network. When the packet reaches the peer PE, the destination MAC address is changed to a public address before the packet is sent to the customer network at the other end. In this way, the GVRP packet can be transparently transmitted across the SP network. The private address is the transparent transmission address used by the GVRP PDUs Tunnel feature.</p> <hr/> <p>Address range for transparent transmission of GVRP packets: 08c6.b300.0006, 011a.a900.0006</p> <hr/> <p>When no transparent transmission address is configured, the default address 08c6.b300.0006 is used.</p>

Configuration Example

❖ Configuring the GVRP PDUs Tunnel Feature

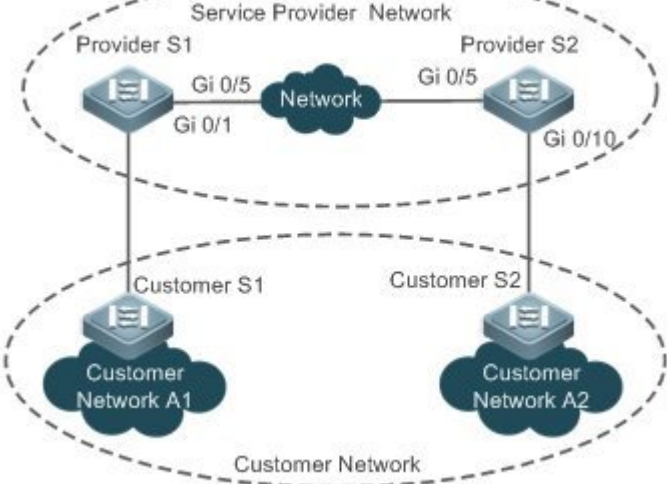
<p>Scenario Figure 11-6</p>	
<p>Configuration Steps</p>	<ul style="list-style-type: none"> ➤ Enable basic QinQ on the PEs (Provider S1 and Provider S2) in the SP network to transmit data packets from the customer network through VLAN 200 in the SP network. ➤ Enable GVRP transparent transmission on the PEs (Provider S1 and Provider S2) in the SP network to allow the SP network to tunnel GVRP packets from the customer network via the GVRP PDUs Tunnel feature.
<p>Provider S1</p>	<p>Step 1: Create VLAN 200 of the SP network.</p> <pre>Qtech#configure terminal Enter configuration commands, one per line. End with CNTL/Z. Qtech(config)#vlan 200 Qtech(config vlan)#exit</pre> <p>Step 2: Enable basic QinQ on the port connected to the customer network to tunnel data from the customer network through VLAN 200.</p> <pre>Qtech(config)#interface gigabitEthernet 0/1 Qtech(config if GigabitEthernet 0/1)#switchport mode dot1q tunnel Qtech(config if GigabitEthernet 0/1)#switchport dot1q tunnel native vlan 200 Qtech(config if GigabitEthernet 0/1)#switchport dot1q tunnel allowed vlan add untagged 200</pre> <p>Step 3: Enable GVRP transparent transmission on the port connected to the</p>

	<p>customer network.</p> <pre>Qtech(config if GigabitEthernet 0/1)#l2protocol tunnel gvrp enable Qtech(config if GigabitEthernet 0/1)#exit</pre> <p>Step 4: Enable GVRP transparent transmission globally.</p> <pre>Qtech(config)#l2protocol tunnel gvrp</pre> <p>Step 5: Configure an uplink port.</p> <pre>Qtech(config)# interface gigabitEthernet 0/5 Qtech(config if GigabitEthernet 0/5)#switchport mode uplink</pre>
Provider S2	The configuration on Provider S2 is similar to that on Provider S1.
Verification	<ul style="list-style-type: none"> ➤ Check whether the GVRP PDUs Tunnel configuration is correct. ➤ Check whether the Tunnel port is configured correctly. Pay attention to the following: <ul style="list-style-type: none"> - The port type is dot1q-tunnel. - The outer tag VLAN is the Native VLAN and added to the VLAN list of the Tunnel port. - The ports on the PEs in the uplink direction are configured as Uplink ports.
Provider S1	<p>1. Check whether the GVRP PDUs Tunnel configuration is correct.</p> <pre>Qtech#show l2protocol tunnel gvrp</pre> <pre>L2protocol tunnel: Gvrp Enable L2protocol tunnel destination mac address: 08c6.b300.0006 GigabitEthernet 0/1 l2protocol tunnel gvrp enable</pre> <p>2. Check whether the QinQ configuration is correct.</p> <pre>Qtech#show running config</pre> <pre>interface GigabitEthernet 0/1 switchport mode dot1q tunnel switchport dot1q tunnel allowed vlan add untagged 200 switchport dot1q tunnel native vlan 200 l2protocol tunnel gvrp enable</pre>

	<pre>! interface GigabitEthernet 0/5 switchport mode uplink</pre>
Provider S2	The verification on Provider S2 is the same as that on Provider S1.

Common Errors

In an SP network, transparent transmission addresses are not configured consistently, which affects the transmission of GVRP PDU frames.

11.5 Monitoring

Clearing

Running the **clear** commands may lose vital information and thus interrupt services.

Description	Command
Clears port counters.	clear gvrp statistics { <i>interface-id</i> all }

Displaying

Description	Command
Displays port counters.	show gvrp statistics { <i>interface-id</i> all }
Displays the current GVRP status.	show gvrp status
Displays the current GVRP configuration.	show gvrp configuration
Displays the information of the GVRP PDUs Tunnel feature.	show l2protocol-tunnel gvrp

Debugging

System resources are occupied when debugging information is output. Therefore, disable debugging immediately after use.

Description	Command
Enables GVRP event debugging.	debug gvrp event
Enables GVRP timer debugging.	debug gvrp timer

12. CONFIGURING LLDP

12.1 Overview

The Link Layer Discovery Protocol (LLDP), defined in the IEEE 802.1AB standard, is used to discover the topology and identify topological changes. LLDP encapsulates local information of a device into LLDP data units (LLDPDUs) in the type/length/value (TLV) format and then sends the LLDPDUs to neighbors. It also stores LLDPDUs from neighbors in the management information base (MIB) to be accessed by the network management system (NMS).

With LLDP, the NMS can learn about topology, for example, which ports of a device are connected to other devices and whether the rates and duplex modes at both ends of a link are consistent. Administrators can quickly locate and rectify a fault based on the information.

A Qtech LLDP-compliant device is capable of discovering neighbors when the peer is either of the following:

- Qtech LLDP-compliant device
- Endpoint device that complies with the Link Layer Discovery Protocol-Media Endpoint Discovery (LLDP-MED)

Protocols and Standards

- IEEE 802.1AB 2005: Station and Media Access Control Connectivity Discovery
- ANSI/TIA-1057: Link Layer Discovery Protocol for Media Endpoint Devices

12.2 Applications

Application	Description
Displaying Topology	Multiple switches, a MED device, and an NMS are deployed in the network topology.
Conducting Error Detection	Two switches are directly connected and incorrect configuration will be displayed.

12.2.1 Displaying Topology

Scenario

Multiple switches, a MED device, and an NMS are deployed in the network topology.

As shown in the following figure, the LLDP function is enabled by default and no additional configuration is required.

- Switch A and Switch B discover that they are neighbors.
- Switch A discovers its neighbor MED device, that is, IP-Phone, through port GigabitEthernet 0/1.
- The NMS accesses MIB of switch A.

Figure 12-1

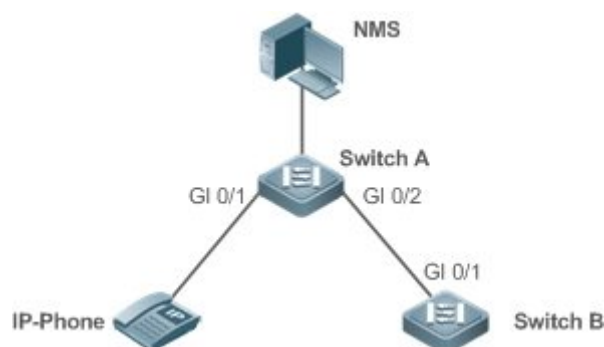

Remark	Qtech Switch A, Switch B, and IP-Phone support LLDP and LLDP-MED.
s	LLDP on switch ports works in TxRx mode. The LLDP transmission interval is 30 seconds and transmission delay is 2 seconds by default.

Deployment

- Run LLDP on a switch to implement neighbor discovery.
- Run the Simple Network Management Protocol (SNMP) on the switch so that the NMS acquires and sets LLDP-relevant information on the switch.

12.2.2 Conducting Error Detection

Scenario

Two switches are directly connected and incorrect configuration will be displayed.

As shown in the following figure, the LLDP function and LLDP error detection function are enabled by default, and no additional configuration is required.

- After you configure a virtual local area network (VLAN), port rate and duplex mode, link aggregation, and maximum transmission unit (MTU) of a port on Switch A, an error will be prompted if the configuration does not match that on Switch B, and vice versa.

Figure 12-2



Remark	Qtech Switch A and Switch B support LLDP.
s	LLDP on switch ports works in TxRx mode. The LLDP transmission interval is 30 seconds and transmission delay is 2 seconds by default.

Deployment

- Run LLDP on a switch to implement neighbor discovery and detect link fault.

12.3 Features

Basic Concepts

❖ LLDPDU

LLDPDU is a protocol data unit encapsulated into an LLDP packet. Each LLDPDU is a sequence of TLV structures. The TLV collection consists of three mandatory TLVs, a series of optional TLVs, and one End Of TLV. The following figure shows the format of an LLDPDU.

Figure 12-3 LLDPDU Format



In the preceding figure:

- M indicates a mandatory TLV.
- In an LLDPDU, Chassis ID TLV, Port ID TLV, Time To Live TLV, and End Of LLDPDU TLV are mandatory and TLVs of other TLVs are optional.

❖ LLDP Encapsulation Format

LLDP packets can be encapsulated in two formats: Ethernet II and Subnetwork Access Protocols (SNAP).

The following figure shows the format of LLDP packets encapsulated in the Ethernet II format.

Figure 12-4 Ethernet II Format



In the preceding figure:

- Destination Address: Indicates the destination MAC address, which is the LLDP multicast address 01-80-C2-00-00-0E.

- Source Address: Indicates the source MAC address, which is the port MAC address.
- Ethertype: Indicates the Ethernet type, which is 0x88CC.
- LLDPDU: Indicates the LLDP protocol data unit.
- FCS: Indicates the frame check sequence.

Figure 12-5 shows the format of LLDP packets encapsulated in the SNAP format.

Figure 12-5 SNAP Format

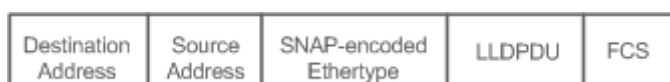

In the preceding figure:

- Destination Address: Indicates the destination MAC address, which is the LLDP multicast address 01-80-C2-00-00-0E.
- Source Address: Indicates the source MAC address, which is the port MAC address.
- SNAP-encoded Ethertype: Indicates the Ethernet type of the SNMP encapsulation, which is AA-AA-03-00-00-00-88-CC.
- LLDPDU: Indicates the LLDP protocol data unit.
- FCS: Indicates the frame check sequence.

❖ TLV

TLVs encapsulated into an LLDPDU can be classified into two types:

- Basic management TLVs
- Organizationally specific TLVs

Basic management TLVs are a collection of basic TLVs used for network management. Organizationally specific TLVs are defined by standard organizations and other institutions, for example, the IEEE 802.1 organization and IEEE 802.3 organization define their own TLV collections.

4. Basic management TLVs

The basic management TLV collection consists of two types of TLVs: mandatory TLVs and optional TLVs. A mandatory TLV must be contained in an LLDPDU for advertisement and an optional TLV is contained selectively.

The following table describes basic management TLVs.

TLV Type	Description	Mandatory/Optional
End Of LLDPDU TLV	Indicates the end of an LLDPDU, occupying two bytes.	Mandatory
Chassis ID TLV	Identifies a device with a MAC address.	Mandatory

Port ID TLV	Identifies a port sending LLDPDUs.	Fixed
Time To Live TLV	Indicates the time to live (TTL) of local information on a neighbor. When a device receives a TLV containing TTL 0, it deletes the neighbor information.	Mandatory
Port Description TLV	Indicates the descriptor of the port sending LLDPDUs.	Optional
System Name TLV	Describes the device name.	Optional
System Description TLV	Indicates the device description, including the hardware version, software version, and operating system information.	Optional
System Capabilities TLV	Describes main functions of the device, such as the bridge, routing, and relay functions.	Optional
Management Address TLV	Indicates the management address, which contains the interface ID and object identifier (OID).	Optional

✔ Qtech LLDP-compliant switches support advertisement of basic management TLVs.

5. Organizationally specific TLVs

Different organizations, such as the IEEE 802.1, IEEE 802.3, IETF and device suppliers, define specific TLVs to advertise specific information about devices. The organizationally unique identifier (OUI) field in a TLV is used to distinguish different organizations.

- Organizationally specific TLVs are optional and are advertised in an LLDPDU selectively. Currently, there are three types of common organizationally specific TLVs: IEEE 802.1 organizationally specific TLVs, IEEE 802.3 organizationally specific TLVs, and LLDP-MED TLVs.

The following table describes IEEE 802.1 organizationally specific TLVs.

TLV Type	Description
Port VLAN ID TLV	Indicates the VLAN identifier of a port.
Port And Protocol VLAN ID TLV	Indicates the protocol VLAN identifier of a port.
VLAN Name TLV	Indicates the VLAN name of a port.
Protocol Identity TLV	Indicates the protocol type supported by a port.

✔ Qtech LLDP-compliant switches do not send the Protocol Identity TLV but receive this TLV.

- IEEE 802.3 organizationally specific TLVs

The following table describes IEEE 802.3 organizationally specific TLVs.

TLV Type	Description
MAC/PHY Configuration//Status TLV	Indicates the rate and duplex mode of a port, and whether to support and enable auto-negotiation.
Power Via MDI TLV	Indicates the power supply capacity of a port.
Link Aggregation TLV	Indicates the link aggregation capacity of a port and the current aggregation state.
Maximum Frame Size TLV	Indicates the maximum size of the frame transmitted by a

	port.
--	-------

- ✔ Qtech LLDP-compliant devices support advertisement of IEEE 802.3 organizationally specific TLVs.

- LLDP-MED TLV

LLDP-MED is an extension to LLDP based on IEEE 802.1AB LLDP. It enables users to conveniently deploy the Voice Over IP (VoIP) network and detect faults. It provides applications including the network configuration policies, device discovery, PoE management, and inventory management, meeting requirements for low cost, effective management, and easy deployment.

The following table describes LLDP-MED TLVs.

TLV Type	Description
LLDP-MED Capabilities TLV	Indicates the type of the LLDP-MED TLV encapsulated into an LLDPDU and device type (network connectivity device or endpoint device), and whether to support LLDP-MED,.
Network Policy TLV	Advertises the port VLAN configuration, supported application type (such as voice or video services), and Layer-2 priority information.
Location Identification TLV	Locates and identifies an endpoint device.
Extended Power-via-MDI TLV	Provides more advanced power supply management.
Inventory – Hardware Revision TLV	Indicates hardware version of a MED device.
Inventory – Firmware Revision TLV	Indicates the firmware version of the MED device.
Inventory – Software Revision TLV	Indicates the software version of the MED device.
Inventory – Serial Number TLV	Indicates the serial number of the MED device.
Inventory – Manufacturer Name TLV	Indicates the name of the manufacturer of the MED device.
Inventory – Model Name TLV	Indicates the module name of the MED device.
Inventory – Asset ID TLV	Indicates the asset identifier of the MED device, used for inventory management and asset tracking.

- ✔ Qtech LLDP-compliant Qtech devices support advertisement of LLDP-MED TLVs.

Overview

Feature	Description
LLDP Work Mode	Configures the mode of transmitting and receiving LLDP packets.
LLDP Transmission Mechanism	Enables directly connected LLDP-compliant devices to send LLDP packets to the peer.
LLDP Reception Mechanism	Enables directly connected LLDP-compliant devices to receive LLDP packets from the peer.

12.3.1 LLDP Work Mode

Configure the LLDP work mode so as to specify the LLDP packet transmission and reception mode.

Working Principle

LLDP provides three work modes:

- TxRx: Transmits and receives LLDPDUs.
- Rx Only: Only receives LLDPDUs.
- Tx Only: Only transmits LLDPDUs.

When the LLDP work mode is changed, the port initializes the protocol state machine. You can set a port initialization delay to prevent repeated initialization of a port due to frequent changes of the LLDP work mode.

Related Configuration

❖ Configuring the LLDP Work Mode

The default LLDP work mode is TxRx.

You can run the **lldp mode** command to configure the LLDP work mode.

If the work mode is set to TxRx, the device can both transmit and receive LLDP packets. If the work mode is set to Rx Only, the device can only receive LLDP packets. If the work mode is set to Tx Only, the device can only transmit LLDP packets. If the work mode is disabled, the device cannot transmit or receive LLDP packets.

12.3.2 LLDP Transmission Mechanism

LLDP packets inform peers of their neighbors. When the LLDP transmission mode is cancelled or disabled, LLDP packets cannot be transmitted to neighbors.

Working Principle

LLDP periodically transmits LLDP packets when working in TxRx or Tx Only mode. When information about the local device changes, LLDP immediately transmits LLDP packets. You can configure a delay time to avoid frequent transmission of LLDP packets caused by frequent changes of local information.

LLDP provides two types of packets:

- Standard LLDP packet, which contains management and configuration information about the local device.
- Shutdown packet: When the LLDP work mode is disabled or the port is shut down, LLDP Shutdown packets will be transmitted. A Shutdown packet consists of the Chassis ID TLV, Port ID TLV, Time To Live TLV, and End OF LLDP TLV. TTL in the Time to Live TLV is 0. When a device

receives an LLDP Shutdown packet, it considers that the neighbor information is invalid and immediately deletes it.

When the LLDP work mode is changed from disabled or Rx to TxRx or Tx, or when LLDP discovers a new neighbor (that is, a device receives a new LLDP packet and the neighbor information is not stored locally), the fast transmission mechanism is started so that the neighbor quickly learns the device information. The fast transmission mechanism enables a device to transmit multiple LLDP packets at an interval of 1 second.

Related Configurati on

❖ Configuring the LLDP Work Mode

The default work mode is TxRx.

Run the **lldp mode txrx** or **lldp mode tx** command to enable the LLDP packet transmission function. Run the **lldp mode rx** or **no lldp mode** command to disable the LLDP packet transmission function.

In order to enable LLDP packet reception, set the work mode to TxRx or Rx Only. If the work mode is set to Rx Only, the device can only receive LLDP packets.

❖ Configuring the LLDP Transmission Delay

The default LLDP transmission delay is 2 seconds.

Run the **lldp timer tx-delay** command to change the LLDP transmission delay.

If the delay is set to a very small value, the frequent change of local information will cause frequent transmission of LLDP packets. If the delay is set to a very large value, no LLDP packet may be transmitted even if local information is changed.

❖ Configuring the LLDP Transmission Interval

The default LLDP transmission interval is 30 seconds.

Run the **lldp timer tx-interval** command to change the LLDP transmission interval.

If the interval is set to a very small value, LLDP packets may be transmitted frequently. If the interval is set to a very large value, the peer may not discover the local device in time.

❖ Configuring the TLVs to Be Advertised

By default, an interface is allowed to advertise TLVs of all types except Location Identification TLV.

Run the **lldp tlv-enable** command to change the TLVs to be advertised.

❖ Configuring the LLDP Fast Transmission Count

By default, three LLDP packets are fast transmitted.

Run the **lldp fast-count** command to change the number of LLDP packets that are fast transmitted.

12.3.3 LLDP Reception Mechanism

A device can discover the neighbor and determine whether to age the neighbor information according to received LLDP packets.

Working Principle

A device can receive LLDP packets when working in TxRx or Rx Only mode. After receiving an LLDP packet, a device conducts validity check. After the packet passes the check, the device checks whether the packet contains information about a new neighbor or about an existing neighbor and stores the neighbor information locally. The device sets the TTL of neighbor information according to the value of TTL TLV in the packet. If the value of TTL TLV is 0, the neighbor information is aged immediately.

Related Configuration

❖ Configuring the LLDP Work Mode

The default LLDP work mode is TxRx.

Run the **lldp mode txrx** or **lldp mode rx** command to enable the LLDP packet reception function. Run the **lldp mode tx** or **no lldp mode** command to disable the LLDP packet reception function.

In order to enable LLDP packet reception, set the work mode to TxRx or Rx Only. If the work mode is set to Tx Only, the device can only transmit LLDP packets.

12.4 Configuration

Configuration	Description and Command	
Configuring the LLDP Function	(Optional) It is used to enable or disable the LLDP function in global or interface configuration mode.	
	lldp enable	Enables the LLDP function.
	no lldp enable	Disables the LLDP function.
Configuring the LLDP Work Mode	(Optional) It is used to configure the LLDP work mode.	
	lldp mode {rx tx txrx }	Configures the LLDP work mode.
	no lldp mode	Shuts down the LLDP work mode.

Configuration	Description and Command	
Configuring the TLVs to Be Advertised	(Optional) It is used to configure the TLVs to be advertised.	
	lldp tlv-enable	Configures the TLVs to be advertised.
	no lldp tlv-enable	Cancels TLVs.
Configures the Management Address to Be Advertised	(Optional) It is used to configure the management address to be advertised in LLDP packets.	
	lldp management-address-tlv [ip-address]	Configures the management address to be advertised in LLDP packets.
	no lldp management-address-tlv	Cancels the management address.
Configuring the LLDP Fast Transmission Count	(Optional) It is used to configure the number of LLDP packets that are fast transmitted.	
	lldp fast-count value	Configures the <u>LLDP fast transmission</u> count.
	no lldp fast-count	Restores the default <u>LLDP fast transmission</u> count.
Configuring the TTL Multiplier and Transmission Interval	(Optional) It is used to configure the TTL multiplier and transmission interval.	
	lldp hold-multiplier value	Configures the TTL multiplier.
	no lldp hold-multiplier	Restores the default TTL multiplier.
	lldp timer tx-interval seconds	Configures the transmission interval.
	no lldp timer tx-interval	Restores the default transmission interval.
Configuring the Transmission Delay	(Optional) It is used to configure the delay time for LLDP packet transmission.	
	lldp timer tx-delay seconds	Configures the transmission delay.
	no lldp timer tx-delay	Restores the default transmission delay.
Configuring the Initialization Delay	(Optional) It is used to configure the delay time for LLDP to initialize on any interface.	
	lldp timer reinit-delay seconds	Configures the initialization delay.
	no lldp timer reinit-delay	Restores the default initialization delay.
Configuring the LLDP Trap Function	(Optional) It is used to configure the LLDP Trap function.	
	lldp notification remote-change enable	Enables the LLDP Trap function.
	no lldp notification remote-change enable	Disables the LLDP Trap function.

Configuration	Description and Command	
	lldp timer notification-interval	Configures the LLDP Trap transmission interval.
	no lldp timer notification-interval	Restores the default LLDP Trap transmission interval.
Configuring the LLDP Error Detection Function	(Optional) It is used to configure the LLDP error detection function.	
	lldp error-detect	Enables the LLDP error detection function.
	no lldp error-detect	Disables the LLDP error detection function.
Configuring the LLDP Encapsulation Format	(Optional) It is used to configure the LLDP encapsulation format.	
	lldp encapsulation snap	Sets the LLDP encapsulation format to SNAP.
	no lldp encapsulation snap	Sets the LLDP encapsulation format to Ethernet II.
Configuring the LLDP Network Policy	(Optional) It is used to configure the LLDP Network Policy.	
	lldp network-policy profile <i>profile-num</i>	Configures an LLDP Network Policy.
	no lldp network-policy profile <i>profile-num</i>	Deletes an LLDP Network Policy.
Configuring the Civic Address	(Optional) It is used to configure the civic address of a device.	
	{ country state county city division neighborhood street-group leading-street-dir trailing-street-suffix street-suffix number street-number-suffix landmark additional-location-information name postal-code building unit floor room type-of-place postal-community-name post-office-box additional-code } <i>ca-word</i>	Configures the civic address of a device.

Configuration	Description and Command	
	<pre>no { country state county city division neighborhood street-group leading-street-dir trailing-street-suffix street-suffix number street-number-suffix landmark additional-location-information name postal-code building unit floor room type-of-place postal-community-name post-office-box additional-code } ca-word</pre>	Deletes civic address of a device.
Configuring the Emergency Telephone Number	(Optional) It is used to configure the emergency telephone number of a device.	
	<pre>lldp location elin identifier id elin-location tel-number</pre>	Configures the emergency telephone number of a device.
	<pre>no lldp location elin identifier id</pre>	Deletes the emergency telephone number of a device.

12.4.1 Configuring the LLDP Function

Configuration Effect

- Enable or disable the LLDP function.

Notes

- To make the LLDP function take effect on an interface, you need to enable the LLDP function globally and on the interface.

Configuration Steps

- Optional.
- Configure the LLDP function in global or interface configuration mode.

Verification

Display LLDP status

- Check whether the LLDP function is enabled in global configuration mode.
- Check whether the LLDP function is enabled in interface configuration mode.

Related Commands

❖ Enabling the LLDP Function

Command	<code>lldp enable</code>
Parameter Description	N/A
Command Mode	Global configuration mode/Interface configuration mode
Usage Guide	The LLDP function takes effect on an interface only after it is enabled in global configuration mode and interface configuration mode.

❖ Disabling the LLDP Function

Command	<code>no lldp enable</code>
Parameter Description	N/A
Command Mode	Global configuration mode/Interface configuration mode
Usage Guide	N/A

Configurati on Example

❖ Disabling the LLDP Function

Configuratio n Steps	Disable the LLDP function in global configuration mode.
	<pre>Qtech(config)#no lldp enable</pre>
Verification	Display global LLDP status.
	<pre>Qtech(config)#show lldp status Global status of LLDP: Disable</pre>

Common Errors

- If the LLDP function is enabled on an interface but disabled in global configuration mode, the LLDP function does not take effect on the interface.
- A port can learn a maximum of five neighbors.
- If a neighbor does not support LLDP but it is connected to an LLDP-supported device, a port may learn information about the device that is not directly connected to the port because the neighbor may forward LLDP packets.

12.4.2 Configuring the LLDP Work Mode

Configurati on Effect

- If you set the LLDP work mode to TxRx, the interface can transmit and receive packets.
- If you set the LLDP work mode to Tx, the interface can only transmit packets but cannot receive packets.
- If you set the LLDP work mode to Rx, the interface can only receive packets but cannot transmit packets.
- If you disable the LLDP work mode, the interface can neither receive nor transmit packets.

Notes

- LLDP runs on physical ports (AP member ports for AP ports). Stacked ports and VSL ports do not support LLDP.

Configurati on Steps

- Optional.
- Set the LLDP work mode to Tx or Rx as required.

Verification

Display LLDP status information on an interface

- Check whether the configuration takes effect.

Related Commands

❖ Configuring the LLDP Work Mode

Command	<code>lldp mode { rx tx txrx }</code>
Parameter	rx: Only receives LLDPDUs.
Description	tx: Only transmits LLDPDUs. txrx: Transmits and receives LLDPDUs.
Command Mode	Interface configuration mode
Usage Guide	To make LLDP take effect on an interface, make sure to enable LLDP globally and set the LLDP work mode on the interface to Tx, Rx or TxRx.

❖ Disabling the LLDP Work Mode

Command	<code>no lldp mode</code>
Parameter	N/A

Description	
Command Mode	Interface configuration mode
Usage Guide	After the LLDP work mode on an interface is disabled, the interface does not transmit or receive LLDP packets.

[Configurati on Example](#)

❖ Configuring the LLDP Work Mode

Configuratio n Steps	Set the LLDP work mode to Tx in interface configuration mode.
	<pre>Qtech(config)#interface gigabitethernet 0/1 Qtech(config if GigabitEthernet 0/1)#lldp mode tx</pre>
Verification	Display LLDP status information on the interface.
	<pre>Qtech(config if GigabitEthernet 0/1)#show lldp status interface gigabitethernet 0/1 Port [GigabitEthernet 0/1] Port status of LLDP : Enable Port state : UP Port encapsulation : Ethernet II Operational mode : TxOnly Notification enable : NO Error detect enable : YES Number of neighbors : 0 Number of MED neighbors : 0</pre>

12.4.3 Configuring the TLVs to Be Advertised

[Configurati on Effect](#)

- Configure the type of TLVs to be advertised to specify the LLDPDUs in LLDP packets.

[Notes](#)

- If you configure the **all** parameter for the basic management TLVs, IEEE 802.1 organizationally specific TLVs, and IEEE 802.3 organizationally specific TLVs, all optional TLVs of these types are advertised.

- If you configure the **all** parameter for the LLDP-MED TLVs, all LLDP-MED TLVs except Location Identification TLV are advertised.
- If you want to configure the LLDP-MED Capability TLV, configure the LLDP 802.3 MAC/PHY TLV first; If you want to cancel the LLDP 802.3 MAC/PHY TLV, cancel the LLDP-MED Capability TLV first.
- If you want to configure LLDP-MED TLVs, configure the LLDP-MED Capability TLV before configuring other types of LLDP-MED TLVs. If you want to cancel LLDP-MED TLVs, cancel the LLDP-MED Capability TLV before canceling other types of LLDP-MED TLVs. If a device is connected to an IP-Phone that supports LLDP-MED, you can configure the Network Policy TLV to push policy configuration to the IP-Phone.
- If a device supports the DCBX function by default, ports of the device are not allowed to advertise IEEE 802.3 organizationally specific TLVs and LLDP-MED TLVs by default.

Configuration Steps

- Optional.
- Configure the type of TLVs to be advertised on an interface.

Verification

Display the configuration of TLVs to be advertised on an interface

- Check whether the configuration takes effect.

Related Commands

❖ Configuring TLVs to Be Advertised

Command	<code>lldp tlv-enable { basic-tlv { all port-description system-capability system-description system-name } dot1-tlv { all port-vlan-id protocol-vlan-id [vlan-id] vlan-name [vlan-id] } dot3-tlv { all link-aggregation mac-physic max-frame-size power } med-tlv { all capability inventory location { civic-location elin } identifier id network-policy profile [profile-num] power-over-ethernet } }</code>
Parameter Description	<p>basic-tlv: Indicates the basic management TLV.</p> <p>port-description: Indicates the Port Description TLV.</p> <p>system-capability: Indicates the System Capabilities TLV.</p> <p>system-description: Indicates the System Description TLV.</p> <p>system-name: Indicates the System Name TLV.</p> <p>dot1-tlv: Indicates the IEEE 802.1 organizationally specific TLVs.</p> <p>port-vlan-id: Indicates the Port VLAN ID TLV.</p> <p>protocol-vlan-id: Indicates the Port And Protocol VLAN ID TLV.</p> <p>vlan-id: Indicates the Port Protocol VLAN ID, ranging from 1 to 4,094.</p>

	<p>vlan-name: Indicates the VLAN Name TLV.</p> <p><i>vlan-id:</i> Indicates the VLAN name, ranging from 1 to 4,094.</p> <p>dot3-tlv: Indicates the IEEE 802.3 organizationally specific TLVs.</p> <p>link-aggregation: Indicates the Link Aggregation TLV.</p> <p>mac-physic: Indicates the MAC/PHY Configuration/Status TLV.</p> <p>max-frame-size: Indicates the Maximum Frame Size TLV.</p> <p>power: Indicates the Power Via MDI TLV.</p> <p>med-tlv: Indicates the LLDP MED TLV.</p> <p>capability: Indicates the LLDP-MED Capabilities TLV.</p> <p>Inventory: Indicates the inventory management TLV, which contains the hardware version, firmware version, software version, SN, manufacturer name, module name, and asset identifier.</p> <p>location: Indicates the Location Identification TLV.</p> <p>civic-location: Indicates the civic address information and postal information.</p> <p>elin: Indicates the emergency telephone number.</p> <p><i>id:</i> Indicates the policy ID, ranging from 1 to 1,024.</p> <p>network-policy: Indicates the Network Policy TLV.</p> <p><i>profile-num:</i> Indicates the Network Policy ID, ranging from 1 to 1,024.</p> <p>power-over-ethernet: Indicates the Extended Power-via-MDI TLV.</p>
Command Mode	Interface configuration mode
Usage Guide	N/A

❖ Canceling TLVs

Command	<pre>no lldp tlv-enable {basic-tlv { all port-description system-capability system-description system-name } dot1-tlv { all port-vlan-id protocol-vlan-id vlan-name } dot3-tlv { all link-aggregation mac-physic max-frame-size power } med-tlv { all capability inventory location { civic-location elin } identifier id network-policy profile [profile-num] power-over-ethernet } }</pre>
Parameter Description	<p>basic-tlv: Indicates the basic management TLV.</p> <p>port-description: Indicates the Port Description TLV.</p> <p>system-capability: Indicates the System Capabilities TLV.</p> <p>system-description: Indicates the System Description TLV.</p> <p>system-name: Indicates the System Name TLV.</p> <p>dot1-tlv: Indicates the IEEE 802.1 organizationally specific TLVs.</p> <p>port-vlan-id: Indicates the Port VLAN ID TLV.</p> <p>protocol-vlan-id: Indicates the Port And Protocol VLAN ID TLV.</p> <p>vlan-name: Indicates the VLAN Name TLV.</p> <p>dot3-tlv: Indicates the IEEE 802.3 organizationally specific TLVs.</p> <p>link-aggregation: Indicates the Link Aggregation TLV.</p> <p>mac-physic: Indicates the MAC/PHY Configuration/Status TLV.</p> <p>max-frame-size: Indicates the Maximum Frame Size TLV.</p> <p>power: Indicates the Power Via MDI TLV.</p>

	<p>med-tlv: Indicates the LLDP MED TLV.</p> <p>capability: Indicates the LLDP-MED Capabilities TLV.</p> <p>Inventory: Indicates the inventory management TLV, which contains the hardware version, firmware version, software version, SN, manufacturer name, module name, and asset identifier.</p> <p>location: Indicates the Location Identification TLV.</p> <p>civic-location: Indicates the civic address information and postal information.</p> <p>elin: Indicates the emergency telephone number.</p> <p><i>id:</i> Indicates the policy ID, ranging from 1 to 1,024.</p> <p>network-policy: Indicates the Network Policy TLV.</p> <p><i>profile-num:</i> Indicates the Network Policy ID, ranging from 1 to 1,024.</p> <p>power-over-ethernet: Indicates the Extended Power-via-MDI TLV.</p>
Command Mode	Interface configuration mode
Usage Guide	N/A

[Configurati on Example](#)

❖ Configuring TLVs to Be Advertised

Configuratio n Steps	Cancel the advertisement of the IEEE 802.1 organizationally specific Port And Protocol VLAN ID TLV.
	<pre>Qtech(config)#interface gigabitethernet 0/1 Qtech(config if GigabitEthernet 0/1)#no lldp tlv enable dot1 tlv protocol vlan id</pre>
Verification	Display LLDP TLV configuration in interface configuration mode.
	<pre>Qtech(config if GigabitEthernet 0/1)#show lldp tlv config interface gigabitethernet 0/1 LLDP tlv config of port [GigabitEthernet 0/1] NAME STATUS DEFAULT Basic optional TLV: Port Description TLV YES YES System Name TLV YES YES System Description TLV YES YES System Capabilities TLV YES YES Management Address TLV YES YES</pre>



IEEE 802.1 extend TLV:		
Port VLAN ID TLV	YES	YES
Port And Protocol VLAN ID TLV	NO	YES
VLAN Name TLV	YES	YES
IEEE 802.3 extend TLV:		
MAC Physic TLV	YES	YES
Power via MDI TLV	YES	YES
Link Aggregation TLV	YES	YES
Maximum Frame Size TLV	YES	YES
LLDP MED extend TLV:		
Capabilities TLV	YES	YES
Network Policy TLV	YES	YES
Location Identification TLV	NO	NO
Extended Power via MDI TLV	YES	YES
Inventory TLV	YES	YES

12.4.4 Configures the Management Address to Be Advertised

Configurati on Effect

- Configure the management address to be advertised in LLDP packets in interface configuration mode.
- After the management address to be advertised is cancelled, the management address in LLDP packets is subject to the default settings.

Notes

- LLDP runs on physical ports (AP member ports for AP ports). Stacked ports and VSL ports do not support LLDP.

Configurati on Steps

- Optional.
- Configure the management address to be advertised in LLDP packets in interface configuration mode.

Verification

Display LLDP information on a local interface

- Check whether the configuration takes effect.

Related Commands

❖ Configuring the Management Address to Be Advertised

Command	lldp management-address-tlv [<i>ip-address</i>]
Parameter Description	<i>ip-address</i> : Indicates the management address to be advertised in an LLDP packet.
Command Mode	Interface configuration mode
Usage Guide	A management address is advertised through LLDP packets by default. The management address is the IPv4 address of the minimum VLAN supported by the port. If no IPv4 address is configured for the VLAN, LLDP keeps searching for the qualified IP address. If no IPv4 address is found, LLDP searches for the IPv6 address of the minimum VLAN supported by the port. If no IPv6 address is found, the loopback address 127.0.0.1 is used as the management address.

❖ Canceling the Management Address

Command	no lldp management-address-tlv
Parameter Description	N/A
Command Mode	Interface configuration mode
Usage Guide	A management address is advertised through LLDP packets by default. The management address is the IPv4 address of the minimum VLAN supported by the port. If no IPv4 address is configured for the VLAN, LLDP keeps searching for the qualified IP address. If no IPv4 address is found, LLDP searches for the IPv6 address of the minimum VLAN supported by the port. If no IPv6 address is found, the loopback address 127.0.0.1 is used as the management address.

Configuration Example

❖ Configuring the Management Address to Be Advertised

Configuration Steps	Set the management address to 192.168.1.1 on an interface.
	<pre>Qtech(config)#interface gigabitethernet 0/1 Qtech(config-if GigabitEthernet 0/1)#lldp management address tlv</pre>

	192.168.1.1
Verification	Display configuration on the interface.
	<pre> Qtech(config if GigabitEthernet 0/1)#show lldp local information interface GigabitEthernet 0/1 Lldp local information of port [GigabitEthernet 0/1] Port ID type : Interface name Port id : GigabitEthernet 0/1 Port description : GigabitEthernet 0/1 Management address subtype : ipv4 Management address : 192.168.1.1 Interface numbering subtype : ifIndex Interface number : 1 Object identifier : 802.1 organizationally information Port VLAN ID : 1 Port and protocol VLAN ID (PPVID) : 1 PPVID Supported : YES PPVID Enabled : NO VLAN name of VLAN 1 : VLAN0001 Protocol Identity : 802.3 organizationally information Auto negotiation supported : YES Auto negotiation enabled : YES PMD auto negotiation advertised : 1000BASE T full duplex mode, 100BASE TX full duplex mode, 100BASE TX half duplex mode, 10BASE T full duplex mode, 10BASE T half duplex mode Operational MAU type : speed(100)/duplex(Full) PoE support : NO Link aggregation supported : YES </pre>

Link aggregation enabled	: NO
Aggregation port ID	: 0
Maximum frame Size	: 1500
LLDP MED organizationally information	
Power via MDI device type	: PD
Power via MDI power source	: Local
Power via MDI power priority	:
Power via MDI power value	:
Model name	: Model name

12.4.5 Configuring the LLDP Fast Transmission Count

Configurati on Effect

- Configure the number of LLDP packets that are fast transmitted.

Configurati on Steps

- Optional.
- Configure the number of LLDP packets that are fast transmitted in global configuration mode.

Verification

Displaying the global LLDP status information

- Check whether the configuration takes effect.

Related Commands

❖ Configuring the LLDP Fast Transmission Count

Command	<code>lldp fast-count value</code>
Parameter Description	<i>value</i> : Indicates the number of LLDP packets that are fast transmitted. The value ranges from 1 to 10. The default value is 3.
Command Mode	Global configuration mode
Usage Guide	N/A

❖ Restoring the Default LLDP Fast Transmission Count

Command	no lldp fast-count
Parameter Description	N/A
Command Mode	Global configuration mode
Usage Guide	N/A

[Configurati on Example](#)

❖ Configuring the LLDP Fast Transmission Count

Configuratio n Steps	Set the LLDP fast transmission count to 5 in global configuration mode.
	<pre>Qtech(config)#lldp fast count 5</pre>
Verification	Display the global LLDP status information.
	<pre>Qtech(config)#show lldp status Global status of LLDP : Enable Neighbor information last changed time : Transmit interval : 30s Hold multiplier : 4 Reinit delay : 2s Transmit delay : 2s Notification interval : 5s Fast start counts : 5</pre>

12.4.6 Configuring the TTL Multiplier and Transmission Interval

[Configurati on Effect](#)

- Configure the TTL multiplier.
- Configure the LLDP packet transmission interval.

[Configurati on Steps](#)

- Optional.
- Perform the configuration in global configuration mode.

Verification

Display LLDP status information on an interface

- Check whether the configuration takes effect.

Related Commands

❖ Configuring the TTL Multiplier

Command	<code>lldp hold-multiplier value</code>
Parameter Description	<i>value</i> : Indicates the TTL multiplier. The value ranges from 2 to 10. The default value is 4.
Command Mode	Global configuration mode
Usage Guide	In an LLDP packet, the value of Time To Live TLV is calculated based on the following formula: Time to Live TLV = TTL multiplier x Packet transmission interval + 1. Therefore, you can modify the Time to Live TLV in LLDP packets by configuring the TTL multiplier.

❖ Restoring the Default TTL Multiplier

Command	<code>no lldp hold-multiplier</code>
Parameter Description	N/A
Command Mode	Global configuration mode
Usage Guide	In an LLDP packet, the value of Time To Live TLV is calculated based on the following formula: Time to Live TLV = TTL multiplier x Packet transmission interval + 1. Therefore, you can modify the Time to Live TLV in LLDP packets by configuring the TTL multiplier.

❖ Configuring the Transmission Interval

Command	<code>lldp timer tx-interval seconds</code>
Parameter Description	<i>seconds</i> : Indicates the LLDP packet transmission interval. The value ranges from 5 to 32,768.
Command Mode	Global configuration mode
Usage Guide	N/A

❖ Restoring the Default Transmission Interval

Command	<code>no lldp timer tx-interval</code>
Parameter Description	N/A
Command Mode	Global configuration mode

Usage Guide	N/A
-------------	-----

[Configurati on Example](#)

❖ Configuring the TTL Multiplier and Transmission Interval

Configuratio n Steps	Set the TTL multiplier to 3 and the transmission interval to 20 seconds. The TTL of local device information on neighbors is 61 seconds.
	<pre>Qtech(config)#lldp hold multiplier 3 Qtech(config)#lldp timer tx interval 20</pre>
Verification	Display the global LLDP status information.
	<pre>Qtech(config)#lldp hold multiplier 3 Qtech(config)#lldp timer tx interval 20 Qtech(config)#show lldp status Global status of LLDP : Enable Neighbor information last changed time : Transmit interval : 20s Hold multiplier : 3 Reinit delay : 2s Transmit delay : 2s Notification interval : 5s Fast start counts : 3</pre>

12.4.7 Configuring the Transmission Delay

[Configurati on Effect](#)

- Configure the delay time for LLDP packet transmission.

[Configurati on Steps](#)

- Optional.
- Perform the configuration in global configuration mode.

[Verification](#)

Displaying the global LLDP status information



- Check whether the configuration takes effect.

Related Commands

❖ Configuring the Transmission Delay

Command	lldp timer tx-delay <i>seconds</i>
Parameter Description	<i>seconds</i> : Indicates the transmission delay. The value ranges from 1 to 8,192.
Command Mode	Global configuration mode
Usage Guide	When local information of a device changes, the device immediately transmits LLDP packets to its neighbors. Configure the transmission delay to prevent frequent transmission of LLDP packets caused by frequent changes of local information.

❖ Restoring the Default Transmission Delay

Command	no lldp timer tx-delay
Parameter Description	N/A
Command Mode	Global configuration mode
Usage Guide	When local information of a device changes, the device immediately transmits LLDP packets to its neighbors. Configure the transmission delay to prevent frequent transmission of LLDP packets caused by frequent changes of local information.

Configurati on Example

❖ Configuring the Transmission Delay

Configuration Steps	Set the transmission delay to 3 seconds.
	<pre>Qtech(config)#lldp timer tx delay 3</pre>
Verification	Display the global LLDP status information.
	<pre>Qtech(config)#show lldp status Global status of LLDP : Enable Neighbor information last changed time : Transmit interval : 30s Hold multiplier : 4 Reinit delay : 2s</pre>

Transmit delay	: 3s
Notification interval	: 5s
Fast start counts	: 3

12.4.8 Configuring the Initialization Delay

Configurati on Effect

- Configure the delay time for LLDP to initialize on any interface.

Configurati on Steps

- Optional.
- Configure the delay time for LLDP to initialize on any interface.

Verification

Display the global LLDP status information

- Check whether the configuration takes effect.

Related Commands

❖ Configuring the Initialization Delay

Command	<code>lldp timer reinit-delay seconds</code>
Parameter Description	<i>seconds</i> : Indicates the initialization delay . The value ranges from 1 to 10 seconds.
Command Mode	Global configuration mode
Usage Guide	Configure the initialization delay to prevent frequent initialization of the state machine caused by frequent changes of the port work mode.

❖ Restoring the Default Initialization Delay

Command	<code>no lldp timer reinit-delay</code>
Parameter Description	N/A
Command Mode	Global configuration mode
Usage Guide	Configure the initialization delay to prevent frequent initialization of the state machine caused by frequent changes of the port work mode.

Configurati on Example

❖ Configuring the Initialization Delay

Configuratio n Steps	Set the initialization delay to 3 seconds.
	<pre>Qtech(config)#lldp timer reinit delay 3</pre>
Verification	Display the global LLDP status information.
	<pre>Qtech(config)#show lldp status Global status of LLDP : Enable Neighbor information last changed time : Transmit interval : 30s Hold multiplier : 4 Reinit delay : 3s Transmit delay : 2s Notification interval : 5s Fast start counts : 3</pre>

12.4.9 Configuring the LLDP Trap Function

Configurati on Effect

- Configure the interval for transmitting LLDP Trap messages.

Configurati on Steps

- ❖ Enabling the LLDP Trap Function
 - Optional.
 - Perform the configuration in interface configuration mode.
- ❖ Configuring the LLDP Trap Transmission Interval
 - Optional.
 - Perform the configuration in global configuration mode.

Verification

Display LLDP status information



- Check whether the LLDP Trap function is enabled.
- Check whether the interval configuration takes effect.

Related Commands

❖ Enabling the LLDP Trap Function

Command	lldp notification remote-change enable
Parameter Description	N/A
Command Mode	Interface configuration mode
Usage Guide	The LLDP Trap function enables a device to send its local LLDP information (such as neighbor discovery and communication link fault) to the NMS server so that administrators learn about the network performance

❖ Disabling the LLDP Trap Function

Command	no lldp notification remote-change enable
Parameter Description	N/A
Command Mode	Interface configuration mode
Usage Guide	The LLDP Trap function enables a device to send its local LLDP information (such as neighbor discovery and communication link fault) to the NMS server so that administrators learn about the network performance.

❖ Configuring the LLDP Trap Transmission Interval

Command	lldp timer notification-interval <i>seconds</i>
Parameter Description	<i>seconds</i> : Indicates the interval for transmitting LLDP Trap messages. The value ranges from 5 to 3,600 seconds. The default value is 5 seconds.
Command Mode	Global configuration mode
Usage Guide	Configure the LLDP Trap transmission interval to prevent frequent transmission of LLDP Trap messages. LLDP changes detected within this interval will be transmitted to the NMS server.

❖ Restoring the LLDP Trap Transmission Interval

Command	no lldp timer notification-interval
Parameter Description	N/A
Command Mode	Global configuration mode
Usage Guide	Configure the LLDP Trap transmission interval to prevent frequent transmission of LLDP Trap

messages. LLDP changes detected within this interval will be transmitted to the NMS server.

Configuration Example

❖ Enabling the LLDP Trap Function and Configuring the LLDP Trap Transmission Interval

Configuration Steps	Enable the LLDP Trap function and set the LLDP Trap transmission interval to 10 seconds.
	<pre>Qtech(config)#lldp timer notification interval 10 Qtech(config)#interface gigabitethernet 0/1 Qtech(config-if GigabitEthernet 0/1)#lldp notification remote change enable</pre>
Verification	Display LLDP status information.
	<pre>Qtech(config-if GigabitEthernet 0/1)#show lldp status Global status of LLDP : Enable Neighbor information last changed time : Transmit interval : 30s Hold multiplier : 4 Reinit delay : 2s Transmit delay : 2s Notification interval : 10s Fast start counts : 3 Port [GigabitEthernet 0/1] Port status of LLDP : Enable Port state : UP Port encapsulation : Ethernet II Operational mode : RxAndTx Notification enable : YES Error detect enable : YES Number of neighbors : 0 Number of MED neighbors : 0</pre>

12.4.10 Configuring the LLDP Error Detection Function

Configuration Effect

- Enable the LLDP error detection function. When LLDP detects an error, the error is logged.
- Configure the LLDP error detection function to detect VLAN configuration at both ends of a link, port status, aggregate port configuration, MTU configuration, and loops.

Notes

N/A

Configuration Steps

- Optional.
- Enable or disable the LLDP error detection function in interface configuration mode.

Verification

Display LLDP status information on an interface

- Check whether the configuration takes effect.

Related Commands

❖ Enabling the LLDP Error Detection Function

Command	<code>lldp error-detect</code>
Parameter Description	N/A
Command Mode	Interface configuration mode
Usage Guide	The LLDP error detection function relies on specific TLVs in LLDP packets exchanged between devices at both ends of a link. Therefore, a device needs to advertise correct TLVs to ensure the LLDP error detection function.

❖ Disabling the LLDP Error Detection Function

Command	<code>no lldp error-detect</code>
Parameter Description	N/A
Command Mode	Interface configuration mode
Usage Guide	The LLDP error detection function relies on specific TLVs in LLDP packets exchanged between devices at both ends of a link. Therefore, a device needs to advertise correct TLVs to ensure the LLDP error

	detection function.
--	---------------------

Configurati on Example

❖ Enabling the LLDP Error Detection Function

Configuratio n Steps	Enable the LLDP error detection function on interface GigabitEthernet 0/1.
	<pre>Qtech(config)#interface gigabitethernet 0/1 Qtech(config if GigabitEthernet 0/1)#lldp error detect</pre>
Verification	Display LLDP status information on the interface.
	<pre>Qtech(config if GigabitEthernet 0/1)#show lldp status interface gigabitethernet 0/1 Port [GigabitEthernet 0/1] Port status of LLDP : Enable Port state : UP Port encapsulation : Ethernet II Operational mode : RxAndTx Notification enable : NO Error detect enable : YES Number of neighbors : 0 Number of MED neighbors : 0</pre>

12.4.11 Configuring the LLDP Encapsulation Format

Configurati on Effect

- Configure the LLDP encapsulation format.

Configurati on Steps

- Optional.
- Configure the LLDP encapsulation format on an interface.

Verification

Display LLDP status information of an interface

- Check whether the configuration takes effect.

Related Commands

❖ Setting the LLDP Encapsulation Format to SNAP

Command	<code>lldp encapsulation snap</code>
Parameter Description	N/A
Command Mode	Interface configuration mode
Usage Guide	The LLDP encapsulation format configuration on a device and its neighbors must be consistent.

❖ Restoring the Default LLDP Encapsulation Format (Ethernet II)

Command	<code>No lldp encapsulation snap</code>
Parameter Description	N/A
Command Mode	Interface configuration mode
Usage Guide	The LLDP encapsulation format configuration on a device and its neighbors must be consistent.

Configurati on Example

❖ Setting the LLDP Encapsulation Format to SNAP

Configuration Steps	Set the LLDP encapsulation format to SNAP.
	<pre>Qtech(config)#interface gigabitEthernet 0/1 Qtech(config-if GigabitEthernet 0/1)#lldp encapsulation snap</pre>
Verification	Display LLDP status information on the interface.
	<pre>Qtech(config-if GigabitEthernet 0/1)#show lldp status interface gigabitEthernet 0/1 Port [GigabitEthernet 0/1] Port status of LLDP : Enable Port state : UP</pre>

Port encapsulation	: Snap
Operational mode	: RxAndTx
Notification enable	: NO
Error detect enable	: YES
Number of neighbors	: 0
Number of MED neighbors	: 0

12.4.12 Configuring the LLDP Network Policy

Configurati on Effect

- Configure the LLDP Network Policy.
- If a device is connected to an IP-Phone that supports LLDP-MED, you can configure the Network Policy TLV to push policy configuration to the IP-Phone, , which enables the IP-Phone to change the tag and QoS of voice streams. In addition to the LLDP Network Policy, perform the following steps on the device: 1. Enable the Voice VLAN function and add the port connected to the IP-Phone to the Voice VLAN. 2. Configure the port connected to the IP-Phone as a QoS trusted port (the trusted DSCP mode is recommended). 3. If 802.1X authentication is also enabled on the port, configure a secure channel for the packets from the Voice VLAN. If the IP-Phone does not support LLDP-MED, enable the voice VLAN function and add the MAC address of the IP-Phone to the Voice VLAN OUI list manually.
- For the configuration of the QoS trust mode, see *Configuring IP QoS*; for the configuration of the Voice VLAN, see *Configuring Voice VLAN*; for the configuration of the secure channel, see *Configuring ACL*.

Configurati on Steps

- Optional.
- Configure the LLDP Network Policy.

Verification

Displaying the LLDP network policy configuration.

- Check whether the configuration takes effect.

Related Commands

- ❖ Configuring the LLDP Network Policy

Command	<code>lldp network-policy profile profile-num</code>
---------	--

Parameter Description	<i>profile-num</i> : Indicates the ID of an LLDP Network Policy. The value ranges from 1 to 1,024.
Command Mode	Global configuration mode
Usage Guide	Run this command to enter the LLDP network policy mode after specifying a policy ID. After entering the LLDP network policy mode, run the { voice voice-signaling } vlan command to configure a specific network policy.

❖ Deleting the LLDP Network Policy

Command	no lldp network-policy profile <i>profile-num</i>
Parameter Description	<i>profile-num</i> : Indicates the LLDP Network Policy ID. The value ranges from 1 to 1,024.
Command Mode	Interface configuration mode
Usage Guide	Run this command to enter the LLDP network policy mode after specifying a policy ID. After entering the LLDP network policy mode, run the { voice voice-signaling } vlan command to configure a specific network policy.

Configurati on Example

❖ Configuring the LLDP Network Policy

Configuratio n Steps	Set the Network Policy TLV to 1 for LLDP packets to be advertised by port GigabitEthernet 0/1 and set the VLAN ID of the Voice application to 3, COS to 4, and DSCP to 6.
	<pre>Qtech#config Qtech(config)#lldp network policy profile 1 Qtech(config lldp network policy)# voice vlan 3 cos 4 Qtech(config lldp network policy)# voice vlan 3 dscp 6 Qtech(config lldp network policy)#exit Qtech(config)# interface gigabitethernet 0/1 Qtech(config if GigabitEthernet 0/1)# lldp tlv enable med tlv network policy profile 1</pre>
Verification	Display the LLDP network policy configuration on the local device.
	<pre>network policy information: network policy profile :1 voice vlan 3 cos 4</pre>

```
voice vlan 3 dscp 6
```

12.4.13 Configuring the Civic Address

Configurati on Effect

- Configure the civic address of a device.

Configurati on Steps

- Optional.
- Perform this configuration in LLDP Civic Address configuration mode.

Verification

Display the LLDP civic address of the local device

- Check whether the configuration takes effect.

Related Commands

❖ Configuring the Civic Address of a Device

Command	Configure the LLDP civic address. Use the no option to delete the address. { country state county city division neighborhood street-group leading-street-dir trailing-street-suffix street-suffix number street-number-suffix landmark additional-location-information name postal-code building unit floor room type-of-place postal-community-name post-office-box additional-code } <i>ca-word</i>
Parameter Description	country : Indicates the country code, with two characters. CH indicates China. state : Indicates the CA type is 1. county : Indicates that the CA type is 2. city : Indicates that the CA type is 3. division : Indicates that the CA type is 4. neighborhood : Indicates that the CA type is 5. street-group : Indicates that the CA type is 6. leading-street-dir : Indicates that the CA type is 16. trailing-street-suffix : Indicates that the CA type is 17. street-suffix : Indicates that the CA type is 18. number : Indicates that the CA type is 19. street-number-suffix : Indicates that the CA type is 20. landmark : Indicates that the CA type is 21. additional-location-information : Indicates that the CA type is 22. name : Indicates that the CA type is 23.

	<p>postal-code: Indicates that the CA type is 24.</p> <p>building: Indicates that the CA type is 25.</p> <p>unit: Indicates that the CA type is 26.</p> <p>floor: Indicates that the CA type is 27.</p> <p>room: Indicates that the CA type is 28.</p> <p>type-of-place: Indicates that the CA type is 29.</p> <p>postal-community-name: Indicates that the CA type is 30.</p> <p>post-office-box: Indicates that the CA type is 31.</p> <p>additional-code: Indicates that the CA type is 32.</p> <p><i>ca-word</i>: Indicates the address.</p>
Command Mode	LLDP Civic Address configuration mode
Usage Guide	After entering the LLDP Civic Address configuration mode, configure the LLDP civic address.

❖ Deleting the Civic Address of a Device

Command	no { country state county city division neighborhood street-group leading-street-dir trailing-street-suffix street-suffix number street-number-suffix landmark additional-location-information name postal-code building unit floor room type-of-place postal-community-name post-office-box additional-code }
Parameter Description	N/A
Command Mode	LLDP Civic Address configuration mode
Usage Guide	After entering the LLDP Civic Address configuration mode, configure the LLDP civic address.

❖ Configuring the Device Type

Command	device-type <i>device-type</i>
Parameter Description	<p><i>device-type</i>: Indicates the device type. The value ranges from 0 to 2. The default value is 1.</p> <p>0 indicates that the device type is DHCP server.</p> <p>1 indicates that the device type is switch.</p> <p>2 indicates that the device type is LLDP MED .</p>
Command Mode	LLDP Civic Address configuration mode
Usage Guide	After entering the LLDP Civic Address configuration mode, configure the device type.

❖ Restoring the Device Type

Command	no device-type
Parameter Description	N/A
Command Mode	LLDP Civic Address configuration mode
Usage Guide	After entering the LLDP Civic Address configuration mode, restore the default settings.

Configurati on Example

❖ Configuring the Civic Address of a Device

Configuratio n Steps	Set the address of port GigabitEthernet 0/1 as follows: set country to CH, city to Fuzhou, and postal code to 350000.
	<pre>Qtech#config Qtech(config)#lldp location civic location identifier 1 Qtech(config lldp civic)# country CH Qtech(config lldp civic)# city Fuzhou Qtech(config lldp civic)# postal code 350000</pre>
Verification	Display the LLDP civic address of port GigabitEthernet 0/1 1.
	<pre>civic location information: Identifier :1 country :CH device type :1 city :Fuzhou postal code :350000</pre>

12.4.14 Configuring the Emergency Telephone Number

Configurati on Effect

- Configure the emergency telephone number of a device.

Configurati on Steps

- Optional.
- Perform this configuration in global configuration mode.

Verification

Display the emergency telephone number of the local device

- Check whether the configuration takes effect.

Related Commands

❖ Configuring the Emergency Telephone Number of a Device

Command	lldp location elin identifier <i>id</i> elin-location <i>tel-number</i>
Parameter Description	<i>id</i> : Indicates the identifier of an emergency telephone number. The value ranges from 1 to 1,024. <i>tel-number</i> : Indicates emergency telephone number, containing 10-25 characters.
Command Mode	Global configuration mode
Usage Guide	Run this command to configure the emergency telephone number.

❖ Deleting the Emergency Telephone Number of a Device

Command	no lldp location elin identifier <i>id</i>
Parameter Description	<i>id</i> : Indicates the identifier of an emergency telephone number. The value ranges from 1 to 1,024.
Command Mode	Global configuration mode
Usage Guide	N/A

Configurati on Example

❖ Configuring the Emergency Telephone Number of a Device

Configuratio n Steps	Set the emergency telephone number of port GigabitEthernet 0/1 to 085285555556.
	<pre>Qtech#config Qtech(config)#lldp location elin identifier 1 elin location 085283671111</pre>
Verification	Display the emergency telephone number of port GigabitEthernet 0/1.
	<pre>elin location information: Identifier :1 elin number :085283671111</pre>

12.5 Monitoring

Clearing

Running the **clear** commands may lose vital information and thus interrupt services.



Description	Command
Clears LLDP statistics.	clear lldp statistics [interface <i>interface-name</i>]
Clears LLDP neighbor information.	clear lldp table [interface <i>interface-name</i>]

Displaying

Description	Command
Displays LLDP information on the local device, which will be organized as TLVs and sent to neighbors.	show lldp local-information [global interface <i>interface-name</i>]
Displays the LLDP civic address or emergency telephone number of a local device.	show lldp location { civic-location elin-location } { identifier <i>id</i> interface <i>interface-name</i> static }
Displays LLDP information on a neighbor.	show lldp neighbors [interface <i>interface-name</i>] [detail]
Displays the LLDP network policy configuration of the local device.	show lldp network-policy { profile [<i>profile-num</i>] interface <i>interface-name</i> }
Displays LLDP statistics.	show lldp statistics [global interface <i>interface-name</i>]
Displays LLDP status information.	show lldp status [interface <i>interface-name</i>]
Displays the configuration of TLVs to be advertised by a port.	show lldp tlv-config [interface <i>interface-name</i>]

Debugging

System resources are occupied when debugging information is output. Therefore, disable debugging immediately after use.

Description	Command
Debugs LLDP error processing.	debug lldp error
Debugs LLDP event processing.	debug lldp event
Debugs LLDP hot backup processing.	debug lldp ha
Debugs the LLDP packet reception.	debug lldp packet
Debugs the LLDP state machine.	debug lldp stm

13. CONFIGURING QINQ

13.1 Overview

QinQ is used to insert a public virtual local area network (VLAN) tag into a packet with a private VLAN tag to allow the double-tagged packet to be transmitted over a service provider (SP) network.

Users on a metropolitan area network (MAN) must be separated by VLANs. IEEE 802.1Q supports only 4,094 VLANs, far from enough. Through the double-tag encapsulation provided by QinQ, a packet is transmitted over the SP network based on the unique outer VLAN tag assigned by the public network. In this way, private VLANs can be reused, which increases the number of available VLAN tags and provides a simple Layer-2 virtual private network (VPN) feature.

Figure 13-1 shows the double-tag insertion process. The entrance to an SP network is called a dot1q-tunnel port, or Tunnel port for short. All frames entering provider edges (PEs) are considered untagged. All tags, whether untagged frames or frames with customer VLAN tags, are encapsulated with the tags of the SP network. The VLAN ID of the SP network is the ID of the default VLAN for the Tunnel port.

Figure 13-1 Outer Tag Encapsulation

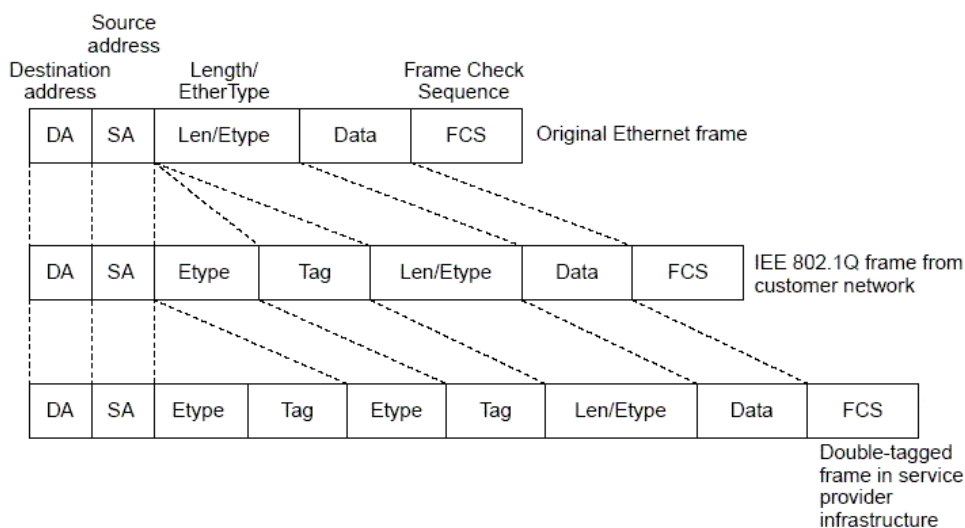

Protocols and Standards

- IEEE 802.1ad

13.2 Applications

Application	Description
Implementing Layer-2 VPN Through Port-Based Basic QinQ	Data is transmitted from Customer A and Customer B to the peer end without conflict on the SP network even if the data comes from the same VLAN.
Implementing Layer-2 VPN and Service Flow Management Through C-TAG-Based Selective QinQ	Outer tags are inserted into frames flexibly based on different customer VLANs to achieve Layer-2 VPN, segregate service flows (e.g., broadband Internet access and IPTV), and implement various QoS policies. Customer tag (C-TAG)-based QinQ is more flexible than port-based QinQ.
Implementing Layer-2 VPN and Service Flow Management Through ACL-Based Selective QinQ	The different service flows, such as broadband Internet access and IPTV, are segregated based on access control lists (ACLs). Different QoS policies are applied to service flows through selective QinQ.
Implementing VLAN Aggregation for Different Services Through VLAN Mapping	Different service flows (PC, IPTV, and VoIP) are transmitted through different VLANs. The VLANs are aggregated on a campus network so that only one VLAN is used to carry the same service flows, thus saving VLAN resources.
Implementing QinQ-Based Layer-2 Transparent Transmission	Customer Network A and Customer Network B in different areas can perform unified Multiple Spanning Tree Protocol (MSTP) calculation or VLAN deployment across the SP network without affecting the SP network.

13.2.1 Implementing Layer-2 VPN Through Port-Based Basic QinQ

Scenario

An SP provides the VPN service to Customer A and Customer B.

- Customer A and Customer B belong to different VLANs on the SP network and achieve communication through respective SP VLANs.
- The VLANs of Customer A and Customer B are transparent to the SP network. The VLANs can be reused without conflicts.
- The Tunnel port encapsulates a native VLAN tag in each packet. Packets are transmitted through the native VLAN over the SP network without impact on the VLANs of Customer A and Customer B, thus implementing simple Layer-2 VPN.

Figure 13-2

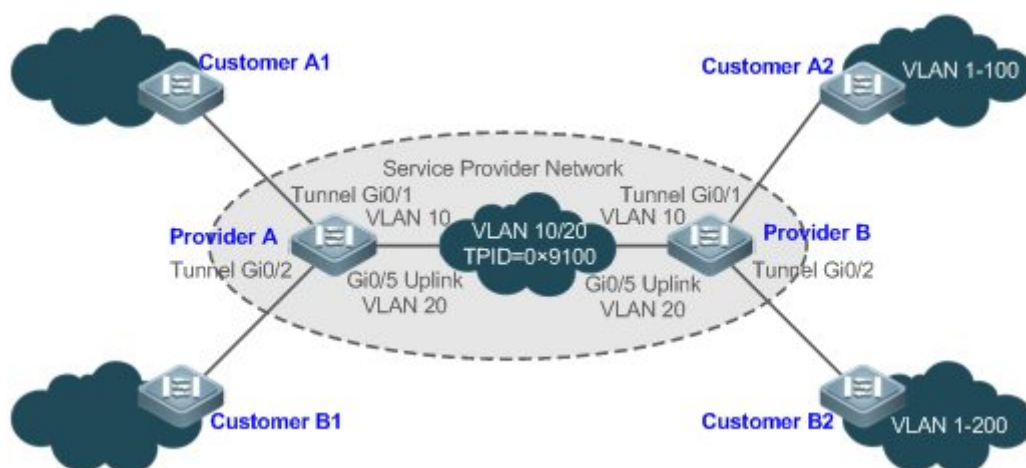

Remarks	<p>Customer A1 and Customer A2 are the customer edges (CEs) for Customer A network. Customer B1 and Customer B2 are the CEs for Customer B network.</p> <p>Provider A and Provider B are the PEs on the SP network. Customer A and Customer B access the SP network through Provider A and Provider B.</p> <p>The VLAN of Customer A ranges from 1 to 100.</p> <p>The VLAN of Customer B ranges from 1 to 200.</p>
----------------	--

Deployment

t

- Enable basic QinQ on PEs to implement Layer-2 VPN.
- The tag protocol identifiers (TPIDs) used by many switches (including Qtech switches) are set to 0x8100, but the switches of some vendors do not use 0x8100. In the latter case, you need to change the TPID value on the Uplink ports of PEs to the values of the TPIDs used by third-party switches.
- Configure priority replication and priority mapping for class of service (CoS) on the Tunnel ports of PEs, and configure different QoS policies for different service flows (for details, see *Configuring QoS*).

13.2.2 Implementing Layer-2 VPN and Service Flow Management Through C-TAG-Based Selective QinQ

Scenario

Basic QinQ encapsulates an outer tag of the native VLAN in a packet. That is, the encapsulation of outer tags depends on the native VLAN on Tunnel ports. Selective QinQ encapsulates an outer tag in a packet based on its inner tag to implement VPN transparent transmission and apply QoS policies flexibly.

- Broadband Internet access and IPTV are important services carried by MANs. The SPs manage different service flows through different VLANs and provides QoS policies for the VLANs or CoS. You can enable C-TAG-based QinQ on PEs to encapsulate outer VLAN tags in the service flows to achieve transparent transmission based on the QoS policies of the SP network.
- Important services and regular services are separated within different VLAN ranges. The customer can transmit service flows transparently over an SP network through C-TAG-based selective QinQ and ensure preferential transmission of important service flows by using the QoS policies of the SP network.

In Figure 13-3, the CEs are aggregated by the floor switches inside residential buildings. The broadband Internet access and IPTV services are segregated by VLANs with different QoS policies.

- The service flows of broadband Internet access and IPTV are transmitted transparently by different VLANs over the SP network.
- The SP network provides QoS policies based on VLANs or CoS. On the PEs, you can encapsulate an outer tag in the service flow based on its inner VLAN tag or set a CoS to ensure preferential transmission of service flows over the SP network.
- The CoS values of service packets can be changed through priority mapping or replication so that the QoS policies of the SP network are applied flexibly.

Figure 13-3

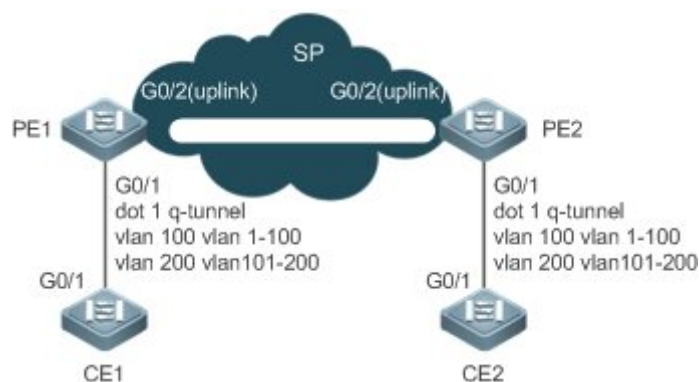

Remarks	<p>CE 1 and CE 2 access the SP network through PE1 and PE2.</p> <p>On CE 1 and CE 2, the broadband Internet access flows are transmitted through VLAN 1–100, and IPTV flows are transmitted through VLAN 101–200.</p> <p>PE 1 and PE 2 are configured with Tunnel ports and VLAN mappings to segregate service flows.</p>
----------------	---

Deployment

t

- Configure C-TAG-based selective QinQ on the ports (G0/1) of PE 1 and PE 2 connected to CE 1 and CE 2 respectively to realize the segregation and transparent transmission of service flows.

- If the SP network provides QoS policies based on VLANs or CoS, you can encapsulate an outer tag in the service flow based on its inner tag or set a CoS through priority replication or mapping on PE 1 and PE 2 to ensure preferential transmission of service flows over the SP network.

13.2.3 Implementing Layer-2 VPN and Service Flow Management Through ACL-Based Selective QinQ

Scenario

The service flows from the customer network may be classified by MAC address, IP address, or protocol type, instead of by VLAN. The customer network may contain many low-end access devices unable to segregate service flows by VLAN IDs. In the preceding two situations, the packets from the customer network cannot be encapsulated with outer tags based on their inner tags to realize transparent transmission and implement QoS policies. Service flows may be classified by MAC address, IP address, or protocol type through ACLs. Selective QinQ uses ACLs to segregate service flows and add or modify outer tags in order to implement Layer-2 VPN and QoS policies based on different service flows.

In Figure 13-4, different VLANs are configured on PE 1 and PE 2 to transmit different service flows classified through ACLs. If the SP network provides QoS policies based on different services, certain services can be transmitted preferentially.

- Outer VLAN tags are encapsulated based on different service flows. The service flows of a customer network can be transmitted transparently, and its branch offices can access each other.
- The SP network provides QoS policies based on the VLAN tags or CoS values to ensure preferential transmission of certain service flows.

Figure 13-4

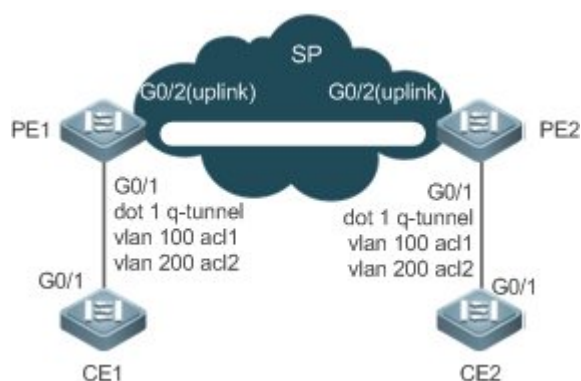

Remark	CE 1 and CE 2 access the SP network through PE1 and PE2.
s	PE 1 and PE 2 classify flows based on ACLs: ACL 1 matches the Point-to-Point Protocol over Ethernet (PPPoE) flows, and ACL 2 matches the IPTV flows.

PE 1 and PE 2 are configured with Tunnel ports, as well as outer tag encapsulation policies applicable to service flows recognized by different ACLs.

Deployment

t

- Configure ACLs on PE 1 and PE 2 to segregate service flows.
- Configure ACL-based selective QinQ on the ports (G0/1) of PE 1 and PE 2 connected to CE 1 and CE 2 respectively to realize the segregation and transparent transmission of service flows.
- If the SP network provides QoS policies based on VLANs or CoS, you can encapsulate an outer tag in the service flow based on its inner tag or set a CoS through priority replication or mapping on PE 1 and PE 2 to ensure preferential transmission of service flows over the SP network.

13.2.4 Implementing VLAN Aggregation for Different Services Through VLAN Mapping

Scenario

The different service flows of different users are segregated on a campus network.

- The different service flows are transmitted through different VLANs on the home gateway.
- The same service flows from different users are segregated on the floor switch.
- The same service flows from different users are sent by a campus switch through one single VLAN.

Figure 13-5

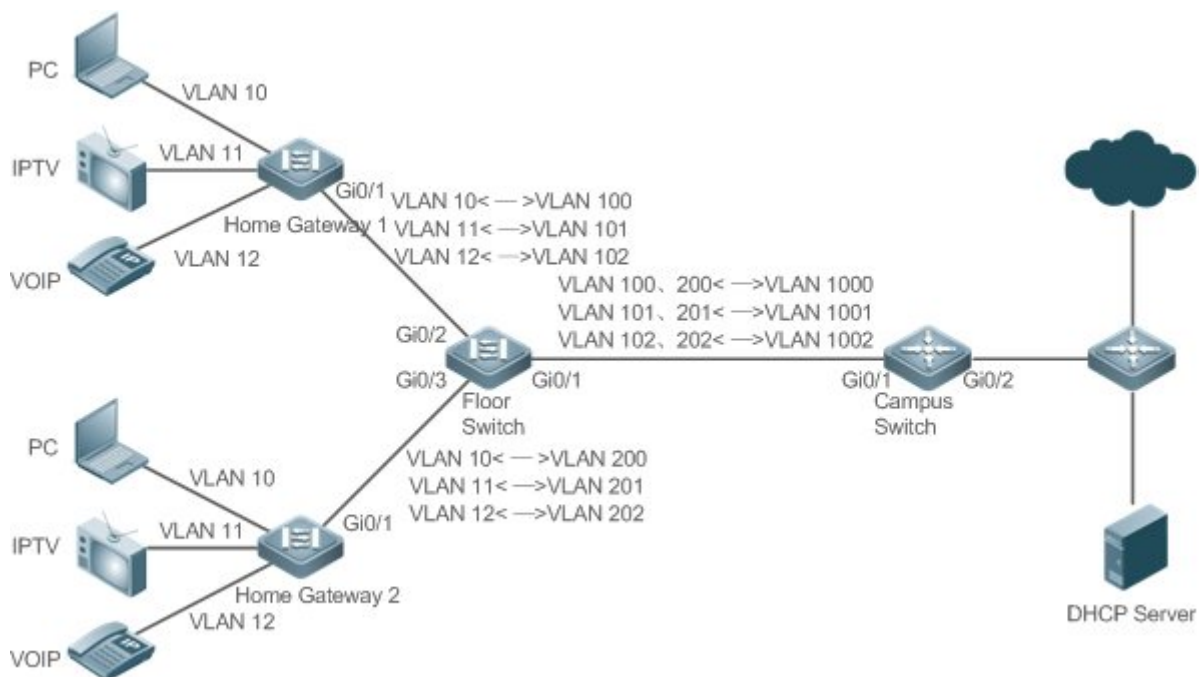

Remark	PC, IPTV, and VoIP are different user services.
s	Switch A and Switch B are the gateway devices of different users. Switch C is a floor switch. Switch D is a campus switch.

Deployment

- On the home gateway devices, configure VLANs for different services to segregate service flows. For example, configure VLAN 10 for the PC service, VLAN 11 for IPTV, and VLAN 12 for VoIP.
- On the ports of the floor switch (Switch D) connected to the home gateway devices, configure VLAN mapping to segregate the service flows of different users.
- On the campus switch, configure VLAN mapping to segregate the service flows.
- Through the preceding deployment, the different service flows of different users are segregated.

13.2.5 Implementing QinQ-Based Layer-2 Transparent Transmission

Scenario

The Layer-2 transparent transmission between customer networks has no impact on the SP network.

- The Layer-2 packets on customer networks are transparent to SP networks and can be transmitted between the customer networks without impact on the SP networks.

Figure 13-6

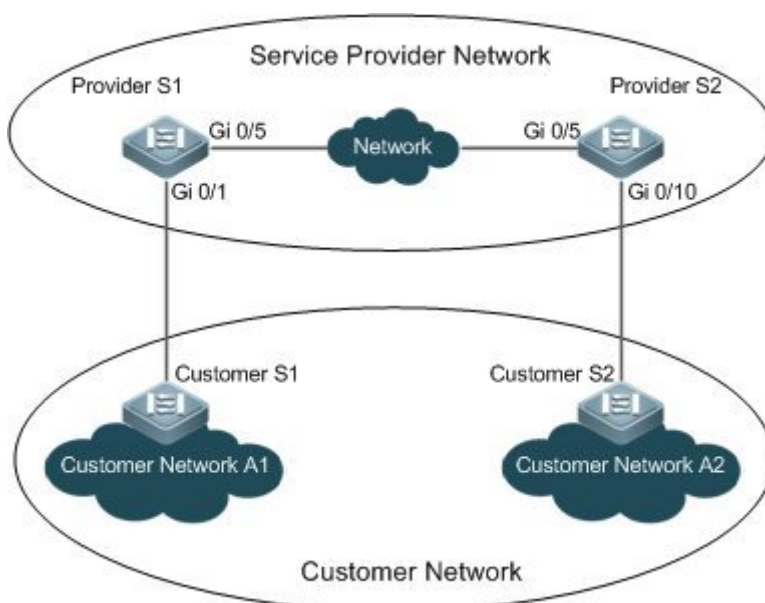

Remark	Customer S1 and Customer S2 access the SP network through Provider S1 and Provider S2.
s	Provider S1 and Provider S2 are enabled with Layer-2 transparent transmission globally, and the Gi 0/1 and Gi 0/10 ports are enabled with Layer-2 transparent transmission.

Deployment

t

- On the ports of the PEs (Provider S1 and Provider S2) connected to Customer S1 and Customer S2 respectively, configure Layer-2 transparent transmission between Customer Network A1 and Customer Network A2 without impact on the SP network.
- Configure STP transparent transmission based on user requirements to realize transparent transmission of bridge protocol data unit (BPDU) packets between Customer Network A1 and Customer Network A2 and to perform unified MSTP calculation across the SP network.
- Configure GARP VLAN Registration Protocol (GVRP) transparent transmission based on user requirements to realize transparent transmission of GVRP packets between Customer Network A1 and Customer Network A2 and dynamic VLAN configuration on the customer networks across the SP network.

13.3 Features

Basic Concepts

❖ Basic QinQ

Configure basic QinQ on a Tunnel port and configure a native VLAN for the port. Packets entering the port are encapsulated with outer tags containing the native VLAN ID. Basic QinQ does not segregate service flows and cannot encapsulate packets flexibly based on VLANs.

❖ Selective QinQ

Selective QinQ is classified into two types: selective QinQ based on C-TAGs and selective QinQ based on ACLs.

In C-TAG-based selective QinQ, outer tags are encapsulated in packets based on the inner tags to segregate service flows and realize transparent transmission.

In ACL-based selective QinQ, outer tags are encapsulated in packets based on the ACLs to segregate service flows.

❖ TPID

An Ethernet frame tag consists of four fields: TPID, User Priority, Canonical Format Indicator (CFI), and VLAN ID.

By default, the TPID is 0x8100 according to IEEE802.1Q. On the switches of some vendors, the TPID is set to 0x9100 or other values. The TPID configuration aims to ensure that the TPIDs of packets to be forwarded are compatible with the TPIDs supported by third-party switches.

❖ Priority Mapping and Priority Replication

The default value of User Priority in Ethernet frame tags is 0, indicating regular flows. You can set this field to ensure preferential transmission of certain packets. You can specify User Priority by setting the value of CoS in a QoS policy.

Priority replication: If the SP network provides a QoS policy corresponding to a specified CoS in the inner tag, you can replicate the CoS of the inner tag to the outer tag to enable transparent transmission based on the QoS policy provided by the SP network.

Priority mapping: If the SP network provides various QoS policies corresponding to specified CoS values for different service flows, you can map the CoS value of the inner tag to the CoS value of the outer tag to ensure preferential transmission of service flows based on the QoS policies provided by the SP network.

❖ Layer-2 Transparent Transmission

STP and GVRP packets may affect the topology of the SP network. If you want to unify the topology of two customer networks separated by the SP network without affecting the SP network topology, transmit the STP and GVRP packets from the customer networks over the SP network transparently.

Overview

Feature	Description
Basic QinQ	Configures the Tunnel port and specifies whether packets sent from the port are tagged.
Selective QinQ	Encapsulates different outer tags in data flows based on ACLs.
VLAN Mapping	Replaces the inner tags of packets with outer tags, and then restores the outer tags to inner tags based on the same rules.
TPID Configuration	By default, the TPID is 0x8100 according to IEEE802.1Q. On the switches of some vendors, the TPIDs of outer tags are set to 0x9100 or other values. The TPID configuration aims to ensure that the TPIDs of packets to be forwarded are compatible with the TPIDs supported by third-party switches.
MAC Address Replication	In ACL-based selective QinQ, the VLAN IDs for the MAC addresses that switches learn belong to the native VLAN. If VLAN conversion is implemented based on ACLs, upon receiving packets from the peer end, the local end may fail to query MAC addresses, causing a flood. To address this problem, MAC address replication is provided to replicate the MAC addresses of the native VLAN to the VLAN where the outer tag is located.
Layer-2 Transparent Transmission	Transmits Layer-2 packets between customer networks without impact on SP networks.

Feature	Description
Priority Replication	If the SP network provides a QoS policy corresponding to a specified CoS value in the inner tag, you can replicate the CoS of the inner tag to the outer tag to enable transparent transmission based on the QoS policy provided by the SP network.
Priority Mapping	If the SP network provides various QoS policies corresponding to specified CoS values for different service flows, you can map the CoS value of the inner tag to the CoS value of the outer tag to ensure preferential transmission of service flows based on the QoS policies provided by the SP network.

13.3.1 Basic QinQ

Basic QinQ can be used to implement simple Layer-2 VPN, but it lacks flexibility in encapsulating outer tags.

[Working Principle](#)

After a Tunnel port receives a packet, the switch adds the outer tag containing the default VLAN ID to the packet. If the received packet already carries a VLAN tag, it is encapsulated as a double-tagged packet. If it does not have a VLAN tag, it is added with the VLAN tag containing the default VLAN ID.

13.3.2 Selective QinQ

Selective QinQ adds different outer tags to data flows flexibly.

[Working Principle](#)

Selective QinQ can be used to encapsulate different outer tags based on inner tags, MAC addresses, protocol numbers, source addresses, destination addresses, priorities, or the port numbers of applications. In this way, packets of different users, services, and priorities are encapsulated with different outer VLAN tags.

You can configure the following selective QinQ policies:

- Add an outer VLAN tag based on the inner VLAN tag.
- Modify an outer VLAN tag based on the outer VLAN tag.
- Modify an outer VLAN tag based on the inner VLAN tag.
- Modify an outer VLAN tag based on the inner and outer VLAN tags.
- Add an outer VLAN tag based on the ACL.
- Modify an outer VLAN tag based on the ACL.
- Modify an inner VLAN tag based on the ACL.

13.3.3 VLAN Mapping

Working Principle

The inner tag of a packet is replaced by an outer tag to allow the packet to be transmitted based on the public network topology. When the packet is transmitted to the customer network, the outer tag is restored to the original inner tag based on the same rule. VLAN mapping supports the following two mapping rules:

- 1:1 VLAN mapping: Changes a VLAN ID to the specified VLAN ID.
- N:1 VLAN mapping: Changes the multiple VLAN IDs to the specified VLAN ID.

1:1 VLAN Mapping Mode 1

1:1 VLAN mapping is mainly applied on floor switches to use different VLANs to carry the same services from different users, as shown in Figure 13-7.

Figure 13-7

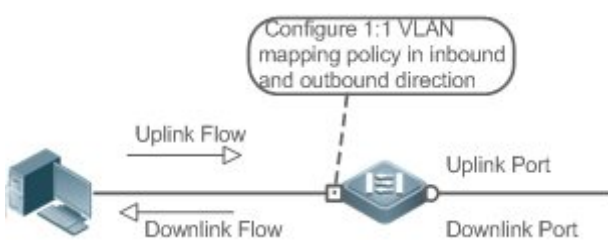

- Configure the Downlink port with a VLAN mapping policy in the inbound direction to map the inner tag of the uplink flow to an outer tag.
- Configure the Uplink port with a VLAN mapping policy in the outbound direction to map the outer tag of the downlink flow to the original inner tag.

1:1 VLAN Mapping Mode 2

Figure 13-8

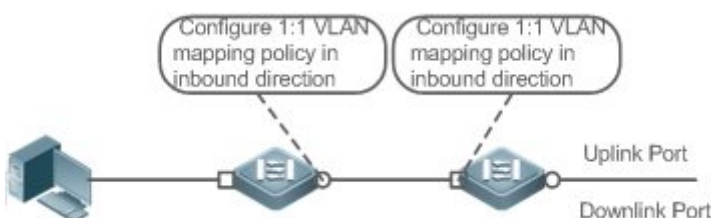

- Configure the Downlink port with a VLAN mapping policy in the inbound direction to map the inner tag of the uplink flow to an outer tag.
- For downstream data flows, Configure the Uplink port with a VLAN mapping policy in the inbound direction to the outer tag of the downlink flow to the original inner tag.

↘ N:1 VLAN Mapping Mode

N:1 VLAN mapping is mainly applied on the campus switch to use one single VLAN to carry the same service from different VLANs, which belongs to different users, as shown in Figure 13-9.

Figure 13-9

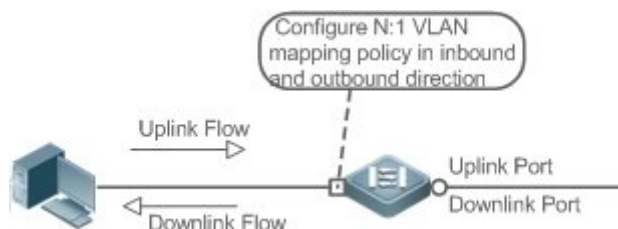

- Configure the Uplink port with a VLAN mapping policy in the inbound direction to map inner tag of the uplink flow to an outer tag.
- Currently, VLAN mapping of downlink flows is not supported.

13.3.4 TPID Configuration

Working Principle

An Ethernet frame tag consists of four fields, namely, TPID, User Priority, CFI, and VLAN ID. By default, the TPID is 0x8100 according to IEEE802.1Q. On the switches of some vendors, the TPIDs of outer tags are set to 0x9100 or other values. The TPID configuration feature allows you to configure TPIDs on ports, which will replace the TPIDs of the outer VLAN tags in packets with the configured TPIDs to realize TPID compatibility.

13.3.5 MAC Address Replication

Working Principle

In ACL-based selective QinQ, the MAC address learned by a switch belongs to the native VLAN. The Tunnel port tags the packet with the specified outer VLAN ID based on the selective QinQ policy. Upon receiving a reply packet containing the same outer VLAN tag, the Tunnel port fails to find the MAC address in the outer VLAN as it is in the native VLAN, causing a flood.

Figure 13-10

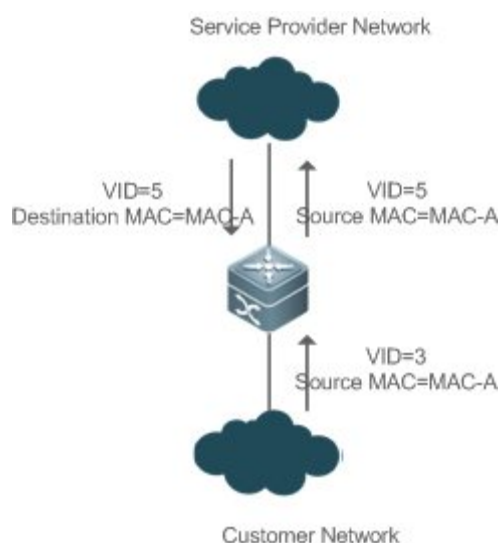

As in Figure 13-10, the customer network is connected to the Tunnel port of the switch. Configured with native VLAN 4, the Tunnel port tags the packet whose source MAC address is A with outer VLAN 5. Upon receiving a packet with inner tag VLAN 3 and source MAC address A, the switch tags the packet with outer VLAN 5. Because the port is configured with native VLAN 4, MAC address A is learned by VLAN 4. Upon receiving the reply packet, the switch looks for MAC address A on VLAN 5 because the outer tag of the packet contains VLAN ID 5. However, MAC address A is not learned by VLAN 5, causing floods.

You can configure the Tunnel port to replicate the MAC address of the native VLAN to the outer VLAN to avoid continuous flooding of the packets from the SP network. You can also configure the Tunnel port to replicate the MAC address of the outer VLAN for the outer tag to the native VLAN to avoid continuous flooding of the packets from the customer network.

13.3.6 Layer-2 Transparent Transmission

Working Principle

The Layer-2 transparent transmission feature is designed to realize the transmission of Layer-2 packets between customer networks without impact on SP networks. When a Layer-2 packet from a customer network enters a PE, the PE changes the destination MAC address of the packet to a private address before forwarding the packet. The peer PE changes the destination MAC address to a public address to send the packet to the customer network at the other end, realizing transparent transmission on the SP network.

13.3.7 Priority Replication

Working Principle

If the SP network provides a QoS policy corresponding to a specified User Priority (CoS) in the inner tag, you can replicate the CoS of the inner tag to the outer tag to enable transparent transmission based on the QoS policy provided by the SP network.

13.3.8 Priority Mapping

Working Principle

If the SP network provides various QoS policies corresponding to specified CoS values for different service flows, you can map the CoS value of the inner tag to the CoS value of the outer tag to ensure preferential transmission of service flows based on the QoS policies provided by the SP network.

13.4 Configuration

Configuration	Description and Command	
Configuring QinQ	<p>⚠ (Mandatory)</p>	
	<code>switchport mode dot1q-tunnel</code>	Configures a Tunnel port.
	<code>switchport dot1q-tunnel allowed vlan { [add] tagged vlist [add] untagged vlist remove vlist }</code>	Adds the VLANs to the Tunnel port in tagged or untagged mode.
	<code>switchport dot1q-tunnel native vlan VID</code>	Configures the default VLAN for the Tunnel port.
Configuring C-TAG-Based Selective QinQ	<p>⚠ (Mandatory) It is used to configure C-TAG-based selective QinQ based on basic QinQ. Selective QinQ prevails over basic QinQ.</p>	
	<code>dot1q outer-vid VID register inner-vid v_list</code>	Configures the policy to add the VLAN IDs of outer tags based on inner tags.
Configuring ACL-Based Selective QinQ	<p>⚠ (Mandatory) It is used to configure ACL-based selective QinQ based on basic QinQ. Selective QinQ prevails over basic QinQ.</p>	
	<code>traffic-redirect access-group acl nested-vlan VID in</code>	Configures the policy to add the VLAN IDs of outer tags based on ACLs.
Configuring VLAN Mapping	<p>⚠ (Mandatory) It is used to enable VLAN mapping.</p>	
	<code>vlan-mapping-in vlan cvlan remark svlan</code>	Configures 1:1 VLAN mapping in the inbound direction. This feature changes the inner VLAN ID of the packet entering a port to a specified outer VLAN ID.
	<code>vlan-mapping-out vlan svlan remark cvlan</code>	Configures 1:1 VLAN mapping in the outbound direction. This feature changes the outer VLAN ID of the packet exiting a port to a specified inner VLAN ID.
	<code>vlan-mapping-in vlan cvlan-list remark svlan</code>	Configures N:1 VLAN mapping in the inbound direction. This feature changes the inner VLAN ID of the packet entering a port to a specified outer VLAN ID.
Configuring TPIDs	<p>⚠ (Optional) It is used to realize TPID compatibility.</p>	
	<code>frame-tag tpid tpid</code>	Configures the TPID of a frame tag. If you want to set it to 0x9100, configure the frame-tag tpid 9100 command. By default, the TPID is in hexadecimal format. You need to configure this feature on an egress port.

Configuration	Description and Command	
Configuring MAC Address Replication	<p>⚠ (Optional) It is used to configure MAC address replication to prevent floods.</p>	
	<p>mac-address-mapping <i>x source-vlan src-vlan-list destination-vlan dst-vlan-id</i></p>	<p>Replicates the dynamic MAC address of the source VLAN to the destination VLAN.</p>
Configuring an Inner/Outer VLAN Tag Modification Policy	<p>⚠ (Optional) It is used to adjust the outer and inner VLAN tags of the packets transmitted over SP networks based on network topologies.</p>	
	<p>dot1q relay-vid <i>VID translate local-vid v_list</i></p>	<p>Configures the policy to change the VLAN IDs of outer tags based on the outer tags.</p>
	<p>dot1q relay-vid <i>VID translate inner-vid v_list</i></p>	<p>Configures the policy to change the VLAN IDs of outer tags based on inner tags.</p>
	<p>dot1q new-outer-vlan <i>VID translate old-outer-vlan vid inner-vlan v_list</i></p>	<p>Configures the policy to change the VLAN IDs of outer tags based on outer and inner tags.</p>
	<p>traffic-redirect access-group <i>acl outer-vlan VID in</i></p>	<p>Configures the policy to change the VLAN IDs of outer tags based on an ACL.</p>
	<p>traffic-redirect access-group <i>acl inner-vlan VID out</i></p>	<p>Configures the policy to change the VLAN IDs of inner tags based on an ACL.</p>
Configuring Priority Mapping and Priority Replication	<p>⚠ (Optional) It is used to apply the QoS policy provided by the SP network by priority replication.</p>	
	<p>inner-priority-trust <i>enable</i></p>	<p>Replicates the value of the User Priority field in the inner tag (C-TAG) to the User Priority field of the outer tag (S-TAG).</p>
	<p>⚠ (Optional) It is used to apply the QoS policy provided by the SP network by priority mapping.</p>	
	<p>dot1q-tunnel cos <i>inner-cos-value remark-cos outer-cos-value</i></p>	<p>Sets the value of the User Priority field in the outer tag (S-TAG) based on the User Priority field of the inner tag (C-TAG).</p>
Configuring Layer-2 Transparent Transmission	<p>⚠ (Optional) It is used to transmit MSTP and GVRP packets transparently based on the customer network topology without affecting the SP network topology.</p>	
	<p>I2protocol-tunnel <i>stp</i></p>	<p>Enables STP transparent transmission in global configuration mode.</p>
	<p>I2protocol-tunnel <i>stp enable</i></p>	<p>Enables STP transparent transmission in interface configuration mode.</p>
	<p>I2protocol-tunnel <i>gvrp</i></p>	<p>Enables GVRP transparent transmission in global configuration mode.</p>

Configuration	Description and Command	
	<code>I2protocol-tunnel gvrp enable</code>	Enables GVRP transparent transmission in interface configuration mode.
	<code>I2protocol-tunnel{STP GVRP}tunnel-dmac mac-address</code>	Configures a transparent transmission address.

- ⚠ Pay attention to the following limitations when you configure QinQ:
- ⚠ Do not configure a routed port as the Tunnel port.
- ⚠ Do not enable 802.1X on the Tunnel port.
- ⚠ Do not enable the port security function on the Tunnel port.
- ⚠ When the Tunnel port is configured as the source port of the remote switched port analyzer (RSPAN), the packets whose outer tags contain VLAN IDs consistent with the RSPAN VLAN IDs are monitored.
- ⚠ If you want to match the ACL applied to the Tunnel port with the VLAN IDs of inner tags, use the **inner** keyword.
- ⚠ Configure the egress port of the customer network connected to the SP network as an Uplink port. If you configure the TPID of the outer tag on a QinQ-enabled port, set the TPID of the outer tag on the Uplink port to the same value.
- ⚠ By default, the maximum transmission unit (MTU) on a port is 1,500 bytes. After added with an outer VLAN tag, a packet is four bytes longer. It is recommended to increase the port MTU on the SP networks to at least 1,504 bytes.
- ⚠ After a switch port is enabled with QinQ, you must enable SVGL sharing before enabling IGMP snooping. Otherwise, IGMP snooping will not work on the QinQ-enabled port.
- ⚠ If a packet matches two or more ACL-based selective QinQ policies without priority, only one policy is executed. It is recommended to specify the priority.

13.4.1 Configuring QinQ

Configurati on Effect

- Implement Layer-2 VPN based on a port-based QinQ policy.

Notes

- It is not recommended to configure the native VLAN of the Trunk port on the PE as its default VLAN, because the Trunk port strips off the tags containing the native VLAN IDs when sending packets.

Configurati on Steps

❖ Configuring the Tunnel port

- (Mandatory) Configure the Tunnel port in interface configuration mode.
- Run the **switchport mode dot1q-tunnel** command in interface configuration mode to configure the Tunnel port.

Command	switchport mode dot1q-tunnel
Parameter Description	N/A
Defaults	By default, no Tunnel port is configured.
Command Mode	Interface configuration mode
Usage Guide	N/A

❖ Configuring the Native VLAN

- Mandatory.
- Configure the native VLAN for the Tunnel port.
- After you configure the native VLAN, add it to the VLAN list of the Tunnel port in untagged mode.
- Run the **switchport dot1q-tunnel native vlan VID** command in interface configuration mode to configure the default VLAN for the Tunnel port.
- If the native VLAN is added to the VLAN list in untagged mode, the outgoing packets on the Tunnel port are not tagged. If the native VLAN is added to the VLAN list in tagged mode, the outgoing packets on the Tunnel port are tagged with the native VLAN ID. To ensure the uplink and downlink transmission, add the native VLAN to the VLAN list in untagged mode.

Command	switchport dot1q-tunnel native vlan VID
Parameter Description	<i>VID</i> : Indicates the ID of the native VLAN. The value ranges from 1 to 4,094. The default value is 1.
Defaults	By default, the native VLAN is VLAN 1.
Command Mode	Interface configuration mode
Usage Guide	Use this command to configure the VLAN of the SP network.

❖ Adding the VLANs on the Tunnel port

- Mandatory.
- After you configure the native VLAN, add it to the VLAN list of the Tunnel port in untagged mode.

- If port-based QinQ is enabled, you do not need to add the VLANs of the customer network to the VLAN list of the Tunnel port.
- If selective QinQ is enabled, add the VLANs of the customer network to the VLAN list of the Tunnel port in tagged or untagged mode based on requirements.
- Run the **switchport dot1q-tunnel allowed vlan { [add] tagged vlist | [add] untagged vlist | remove vlist }** command in interface configuration mode to add VLANs to the VLAN list of the Tunnel port. Upon receiving packets from corresponding VLANs, the Tunnel port adds or removes tags based on the settings.

Command	switchport dot1q-tunnel allowed vlan { [add] tagged vlist [add] untagged vlist remove vlist }
Parameter Description	<i>v_list</i> : Indicates the list of the VLANs on the Tunnel port.
Defaults	By default, VLAN 1 is added to the VLAN list of the Tunnel port in untagged mode. Other VLANs are not added.
Command Mode	Interface configuration mode
Usage Guide	Use this command to add or remove VLANs on the Tunnel port and specify whether the outgoing packets are tagged or untagged. If basic QinQ is enabled, add the native VLAN to the VLAN list of the Tunnel port in untagged mode.

Verification

Check the Tunnel port configuration.

- Check whether the Tunnel port is configured properly on a switch.

Configuration Example

❖ Configuring Basic QinQ to Implement Layer-2 VPN

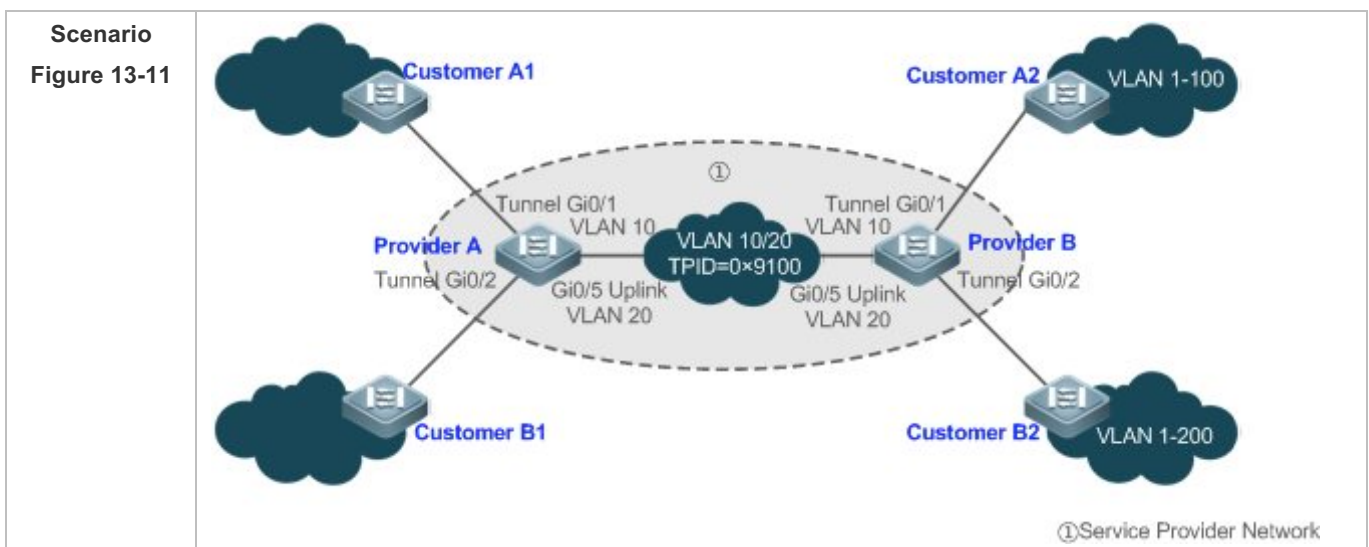

Configuration Steps	<ul style="list-style-type: none"> ● Configure Tunnel ports on the PEs and connect the CEs to the Tunnel ports. ● Configure the native VLANs for the Tunnel ports and add the native VLANs to the VLAN lists of the Tunnel ports respectively in untagged mode. ● Configure VLANs on the customer networks based on requirements. <hr/> <p>i QinQ-enabled switches encapsulate outer tags in packets for transmission over the SP network. Therefore, you do not need to configure customer VLANs on the PEs.</p> <p>i The TPID is 0x8100 by default according to IEEE802.1Q. On some third-party switches, the TPID is set to a different value. If such switches are deployed, set the TPIDs on the ports connected to the third-party switches to realize TPID compatibility.</p> <p>⚠ If the PEs are connected through Trunk ports or Hybrid ports, do not configure the native VLANs for the Trunk ports or Hybrid ports as the default VLANs for the Tunnel ports. The Trunk ports or Hybrid ports strip off the VLAN tags containing the Native VLAN IDs when sending packets.</p> <hr/>
Provider A	<p>Step 1: Create VLAN 10 and VLAN 20 on the SP network to segregate the data of Customer A and Customer B.</p> <pre> ProviderA#configure terminal Enter configuration commands, one per line. End with CNTL/Z. ProviderA(config)#vlan 10 ProviderA(config vlan)#exit ProviderA(config)#vlan 20 ProviderA(config vlan)#exit </pre> <p>Step 2: Enable basic QinQ on the port connected to the network of Customer A to use VLAN 10 for tunneling.</p> <pre> ProviderA(config)#interface gigabitEthernet 0/1 ProviderA(config if GigabitEthernet 0/1)#switchport mode dot1q tunnel ProviderA(config if GigabitEthernet 0/1)#switchport dot1q tunnel native vlan 10 ProviderA(config if GigabitEthernet 0/1)#switchport dot1q tunnel allowed vlan add untagged 10 </pre> <p>Step 3: Enable basic QinQ on the port connected to the network of Customer B to use VLAN 20 for tunneling.</p> <pre> ProviderA(config)#interface gigabitEthernet 0/2 ProviderA(config if GigabitEthernet 0/2)#switchport mode dot1q tunnel </pre>

	<pre>ProviderA(config if GigabitEthernet 0/2)#switchport dot1q tunnel native vlan 20 ProviderA(config if GigabitEthernet 0/2)#switchport dot1q tunnel allowed vlan add untagged 20</pre> <p>Step 4: Configure an Uplink port.</p> <pre>ProviderA(config)# interface gigabitEthernet 0/5 ProviderA(config if GigabitEthernet 0/5)#switchport mode uplink</pre> <p>Step 5: Change the TPID of the outgoing packets on the Uplink port to a value (for example, 0x9100) recognizable by third-party switches.</p> <pre>ProviderA(config if GigabitEthernet 0/5)#frame tag tpid 9100</pre> <p>Step 6: Configure Provider B by performing the same steps.</p>
Verification	<p>Customer A1 sends a packet containing VLAN ID 100 destined to Customer A2. The packet through Provider A is tagged with the outer tag specified by the Tunnel port. The packet that reaches Customer A2 carries the original VLAN ID 100.</p> <p>Check whether the Tunnel port is configured correctly.</p> <p>Check whether the TPID is configured correctly.</p>
Provider A	<pre>ProviderA#show running config interface GigabitEthernet 0/1 switchport mode dot1q tunnel switchport dot1q tunnel allowed vlan add untagged 10 switchport dot1q tunnel native vlan 10 spanning tree bpdufilter enable ! interface GigabitEthernet 0/2 switchport mode dot1q tunnel switchport dot1q tunnel allowed vlan add untagged 20 switchport dot1q tunnel native vlan 20 spanning tree bpdufilter enable ! interface GigabitEthernet 0/5 switchport mode uplink frame tag tpid 0x9100 ProviderA#show interfaces dot1q tunnel</pre>

	<pre> =====Interface Gi0/1===== Native vlan: 10 Allowed vlan list:1,10, Tagged vlan list: =====Interface Gi0/2===== Native vlan: 20 Allowed vlan list:1,20, Tagged vlan list: ProviderA#show frame tag tpid Ports Tpid Gi0/5 0x9100 </pre>
Provider B	Check Provider B by performing the same steps.

Common Errors

- The native VLAN is not added to the VLAN list of the Tunnel port in untagged mode.
- No TPID is configured on the port connected to the third-party switch on which TPID is not 0x8100. As a result, packets cannot be recognized by the third-party switch.

13.4.2 Configuring C-TAG-Based Selective QinQ

Configuration Effect

- Encapsulate outer VLAN tags (S-TAGs) in packets based on inner tags to ensure preferential transmission and management of Layer-2 VPN and service flows.

Notes

- C-TAG-based selective QinQ must be configured based on basic QinQ.
- Some selective QinQ policies are not supported on some products due to limitations of chips.
- If you need to continue to adopt the VLAN tag priority specified by the customer network, you can configure priority replication to configure an outer tag the same as the inner tag.
- If the SP network requires the transmission of packets based on the priority of the outer tag, you need to configure priority replication to set the CoS of the outer tag to the specified value.



Configurati on Steps

❖ Configuring a Policy to Add the VLAN IDs of Outer Tags Based on Inner Tags

- Mandatory.
- Upon receiving a packet, the Tunnel port adds the VLAN ID of the outer tag based on the VLAN ID of the inner tag. This function enables the Tunnel port to add the VLAN ID of the inner tag to the outer tag and adds the port to the VLAN in untagged mode. In this way, the outgoing packets carry the original inner tags.

i The ACL-based QinQ policy prevails over the port-based and C-TAG-based QinQ policy.

i When a member port is added to or removed from an aggregate port (AP), the QinQ policy configured on the AP port will be deleted. You need to configure the policy again. It is recommended that you configure a selective QinQ policy on the AP port after you configure its member ports.

⚠ You must configure the Tunnel port and the port connected to the public network to permit packets with specified VLAN IDs (including the native VLAN ID) in the outer tag to pass through.

Command	<code>dot1q outer-vid VID register inner-vid v_list</code>
Parameter Description	N/A
Defaults	By default, no policy is configured.
Command Mode	Interface configuration mode
Usage Guide	N/A

Verification

- Check whether the users within the VLANs can communicate with each other.
- Check whether Layer-2 VPN is implemented.
- Check whether different service traffic is transmitted based on the selective QinQ policy, such as outer tag insertion, priority replication, and priority mapping.

Configurati on Example

- ❖ Implementing Layer-2 VPN and Service Flow Management Through C-TAG-Based Selective QinQ

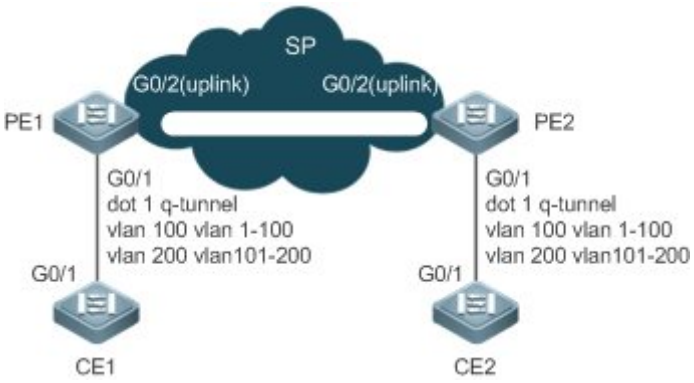
<p>Scenario Figure 13-12</p>	
<p>Configuration Steps</p>	<ul style="list-style-type: none"> ● Configure the ports on PE 1 and PE 2 connected to CE 1 and CE 2 as Tunnel ports. ● Configure a selective QinQ policy to add an outer tag to the packet based on its inner tag. ● If the SP network provides a VLAN-based QoS policy, the policy enables the port to add the outer tags with the corresponding VLAN ID to the specified service flow packets. ● If the SP network provides a CoS-based QoS policy and the CoS value is the same as that of the inner tag, you can configure priority mapping to replicate the CoS value of the inner tag to the outer VLAN tag so that the packet is transmitted based on the priority policy for the inner tag. ● If the SP network provides a CoS-based QoS policy, you can configure priority mapping to set the CoS value of the outer VLAN tag to a specified value so that the packet is transmitted based on the priority policy.
<p>PE1</p>	<p>Step 1: Configure the VLAN for transparent transmission.</p> <pre>PE1#configure terminal Enter configuration commands, one per line. End with CNTL/Z. PE1(config)#vlan 100 PE1(config vlan)#exit PE1(config)#vlan 200 PE1(config vlan)#exit</pre> <p>Step 2: On the Downlink port of the access switch, configure a selective QinQ policy to add outer tags based on inner tags.</p> <p>Configure port Gi 0/1 as a Tunnel port.</p> <pre>PE1(config)#interface gigabitEthernet 0/1</pre>

	<pre>PE1(config if)# switchport mode dot1q tunnel</pre> <p>Add VLAN 101 and VLAN 201 of the SP to the VLAN list of the Tunnel port and configure the Tunnel port to strip off the outer tag from incoming packets.</p> <pre>PE1(config if)# switchport dot1q tunnel allowed vlan add untagged 100,200</pre> <p>Configure the Tunnel port to add outer tag VLAN 100 to incoming data frames containing inner tag VLAN 1–100.</p> <pre>PE1(config if)# dot1q outer vid 100 register inner vid 1 100</pre> <p>Configure the Tunnel port to add outer tag VLAN 200 to incoming data frames containing inner tag VLAN 101-200.</p> <pre>PE1(config if)# dot1q outer vid 200 register inner vid 101 200</pre> <p>Step 3: Configure the port that accesses the SP network as an Uplink port.</p> <pre>PE1(config)# interface gigabitEthernet 0/2</pre> <pre>PE1(config if GigabitEthernet 0/2)#switchport mode uplink</pre>
PE2	<ul style="list-style-type: none"> ● Perform the same configuration on PE 2.
Verification	<p>Verify the configuration by checking whether:</p> <ul style="list-style-type: none"> ● The Downlink port is configured as a Tunnel port. ● The VLAN specified by the outer tag is added to the VLAN list of the Tunnel port. ● The selective QinQ policy on the Tunnel port is correct. ● The Uplink port is configured correctly. <p>Step 1: Check whether the VLAN mapping policy is correct.</p>
PE1	<pre>PE1#show running config interface gigabitEthernet 0/1</pre> <pre>interface GigabitEthernet 0/1</pre> <pre> switchport mode dot1q tunnel</pre> <pre> switchport dot1q tunnel allowed vlan add untagged 100,200</pre> <pre> dot1q outer vid 100 register inner vid 1 200</pre> <pre> dot1q outer vid 200 register inner vid 101 200</pre> <pre> spanning tree bpdufilter enable</pre> <pre>!</pre> <p>Step 2: Check the C-TAG-based selective QinQ policy. Check whether the mapping relationship between the inner and outer VLAN tags is correct.</p>

```
PE1#show registration table
```

Ports	Type	Outer VID	Inner VID list
Gi0/1	Add outer	100	1 200
Gi0/1	Add outer	200	101 200

13.4.3 Configuring ACL-Based Selective QinQ

Configurati on Effect

- Encapsulate outer VLAN tags (S-TAGs) in packets based on the ACL-based flow classification to allow the SP network to manage different services.

Notes

- ACL-based selective QinQ must be configured based on basic QinQ.
- Some selective QinQ policies are not supported on some products due to limitations of chips.
- If you need to continue to adopt the VLAN tag priority specified by the customer network, you can configure priority replication to configure an outer tag the same as the inner tag.
- If the SP network requires the transmission of packets based on the priority of the outer tag, you need to configure priority replication to set the CoS of the outer tag to the specified value.

- i** The ACL-based QinQ policy prevails over the port-based and C-TAG-based QinQ policy.
- i** When an ACL is deleted, the related policy will be automatically deleted.
- i** Upon receiving a packet with two or more tags, the Tunnel port cannot add an outer tag to the packet based on the ACL-based selective QinQ policy.
- i** If a packet matches two or more ACL-based selective QinQ policies without priority, only one policy is executed. It is recommended to specify the priority.
- ⚠** You must configure the Tunnel port and the port connected to the public network to permit packets with specified VLAN IDs (including the native VLAN ID) in the outer tag to pass through.

Configurati on Steps

- ❖ Configuring a Policy to Add the VLAN IDs of Outer Tags Based on ACLs

- Mandatory.
- The Tunnel port adds outer tags with different VLAN IDs to incoming packets based on the packet content.

Command	<code>traffic-redirect access-group <i>acl</i> nested-vlan <i>VID</i> in</code>
Parameter Description	N/A
Defaults	By default, no policy is added.
Command Mode	Interface configuration mode
Usage Guide	N/A

Verification

- Check whether the users of the same service in different branch offices can communicate with each other and whether specified service data is transmitted preferentially through virtual private LAN segment (VPLS) configuration.
- Check whether Layer-2 VPN is implemented.
- Check whether different service traffic is transmitted based on the selective QinQ policy, such as outer tag insertion, priority replication, and priority mapping.

Configuration Example

❖ Implementing Layer-2 VPN and Service Flow Management Through ACL-Based Selective QinQ

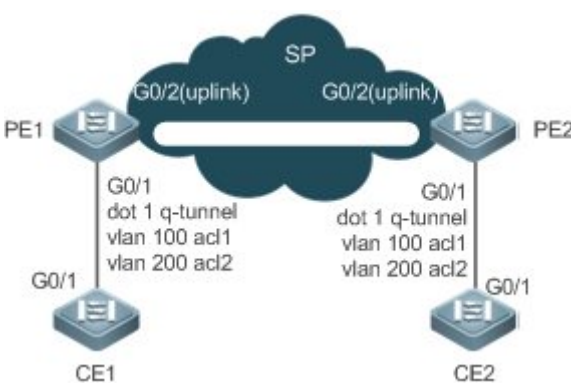
<p>Scenario Figure 13-13</p>	
<p>Configuration Steps</p>	<ul style="list-style-type: none"> ● Configure the ports on PE 1 and PE 2 connected to CE 1 and CE 2 as Tunnel ports. ● Configure ACL policies on PE 1 and PE 2 to segregate the service flows from the customer network. ● On the Tunnel ports, configure a selective QinQ policy to add an outer tag to the packet based on ACL policies.

	<ul style="list-style-type: none">● If the SP network provides a VLAN-based QoS policy, the policy enables the port to add the corresponding VLAN ID to the outer tags of the specified service flow.● If the SP network provides a CoS-based QoS policy, you can configure priority mapping to set the CoS value of the outer VLAN tag to a specified value so that the packet is transmitted based on the priority policy.
PE 1	<p>Step 1: Create an ACL to permit flows of PPPoE type (0x8863/0x8864) and IPoE type (0x0800) to pass through.</p> <pre>PE1#configure terminal Enter configuration commands, one per line. End with CNTL/Z. PE1(config)# expert access list extended acl1 PE1(config exp nacl)# permit 0x8863 any any PE1(config exp nacl)# permit 0x8864 any any PE1(config exp nacl)#exit PE1(config)# expert access list extended acl2 PE1(config exp nacl)#permit 0x0800 any any</pre> <p>Step 2: Configure VLAN 100 and VLAN 200 on the SP network to segregate data.</p> <pre>PE#configure terminal Enter configuration commands, one per line. End with CNTL/Z. PE1(config)#vlan 100 PE1(config vlan)#exit PE1(config)#vlan 200 PE1(config vlan)#exit</pre> <p>Step 3: On the Downlink port of the access switch, configure a selective QinQ policy to add outer VLAN tags based on ACLs.</p> <p>Configure port Gi 0/1 as a Tunnel port.</p> <pre>PE1(config)#interface gigabitEthernet 0/1 PE1(config if)# switchport mode dot1q tunnel</pre> <p>Add VLAN 100 and VLAN 200 of the SP to the VLAN list of the Tunnel port and configure the Tunnel port to strip off the outer tag from incoming packets.</p> <pre>PE1(config if)#switchport dot1q tunnel allowed vlan add untagged 100,200</pre> <p>Configure the Tunnel port to add outer tag VLAN 100 to the incoming data frames which match ACL 1.</p>

	<pre>PE1(config if)# traffic redirect access group acl1 nested vlan 100 in</pre> <p>Configure the Tunnel port to add outer tag VLAN 200 to the incoming data frames which match ACL 2.</p> <pre>PE1(config if)# traffic redirect access group acl1 nested vlan 200 in</pre> <p>Step 4: Configure the port connected to the SP network as an Uplink port.</p> <pre>PE1(config)# interface gigabitEthernet 0/2</pre> <pre>PE1(config if GigabitEthernet 0/2)#switchport mode uplink</pre>								
Verification	<p>Check whether the users of the same service in different branch offices can communicate with each other and whether specified service data is transmitted preferentially.</p> <ul style="list-style-type: none"> ● Check whether Layer-2 VPN is implemented. ● Check whether the ACL is correct. ● Check whether the service priority is correct. ● Check whether the Downlink port is configured as a Tunnel port, whether the outer tag VLAN is added to the VLAN list of the Tunnel port, and whether the mapping policy on the Tunnel port is correct. 								
PE1	<p>Step 1: Check whether the Tunnel port is configured correctly.</p> <pre>Qtech#show running config interface gigabitEthernet 0/1</pre> <pre>interface GigabitEthernet 0/1 switchport mode dot1q tunnel switchport dot1q tunnel allowed vlan add untagged 100,200 traffic redirect access group acl1 nested vlan 100 in traffic redirect access group acl2 nested vlan 200 in spanning tree bpdufilter enable !</pre> <p>Step 2: Check the ACL-based selective QinQ policy. Check whether the mapping relationship between the inner and outer VLAN tags is correct.</p> <pre>PE1#show traffic redirect</pre> <table border="1" data-bbox="316 1832 1469 1977"> <thead> <tr> <th>Ports</th> <th>Type</th> <th>VID</th> <th>Match filter</th> </tr> </thead> <tbody> <tr> <td>Gi0/1</td> <td>Nested vid</td> <td>101</td> <td>acl1</td> </tr> </tbody> </table>	Ports	Type	VID	Match filter	Gi0/1	Nested vid	101	acl1
Ports	Type	VID	Match filter						
Gi0/1	Nested vid	101	acl1						

Gi0/1	Nested vid	201	acl2
-------	------------	-----	------

Common Errors

- No ACL policy is configured.
- ACL policies are used to segregate flows based on MAC addresses. Packet floods will occur if MAC address replication is not configured.

13.4.4 Configuring VLAN Mapping

Configuration Effect

- Replace the inner tags of the packets with the outer tags to allow the packets to be transmitted based on the VLAN planning on the SP network.

Notes

- VLAN mapping can be configured only on Access ports, Trunk ports, Hybrid ports, or Uplink ports.

⚠ After VLAN mapping is configured, the VLAN IDs of the packets sent to the CPU are changed to the specified VLAN ID.

⚠ It is not recommended to configure VLAN mapping and selective QinQ on one port.

Configuration Steps

- ❖ Configuring 1:1 VLAN Mapping
 - Mandatory if the 1:1 mode is used. Configure a 1:1 VLAN mapping rule.
 - Run the **vlan-mapping-in vlan CVID remark SVID** command or the **vlan-mapping-out vlan SVID remark CVID** command on a Trunk port or an Uplink port to enable 1:1 VLAN mapping.

Command	vlan-mapping-in vlan <i>src-vlan-list</i> remark <i>dest-vlan</i>
Parameter	<i>src-vlan-list</i> : Indicates the customer VLAN.
Description	<i>dest-vlan</i> : Indicates the service VLAN, which is the VLAN where the SP network is located.
Defaults	
Command Mode	Interface configuration mode
Usage Guide	Use this command to configure 1:1 VLAN mapping in the inbound direction.

Command	vlan-mapping-out vlan <i>src-vlan</i> remark <i>dest-vlan</i>
Parameter	<i>src-vlan</i> : Indicates the service VLAN, which is the VLAN where the SP network is located.

Description	<i>dest-vlan</i> : Indicates the customer VLAN.
Defaults	
Command Mode	Interface configuration mode
Usage Guide	Use this command to configure 1:1 VLAN mapping in the outbound direction.

❖ Configuring N:1 VLAN Mapping

- Mandatory if the N:1 mode is used. Configure an N:1 VLAN mapping rule.
- Run the **vlan-mapping-in vlan CVID-LIST remark SVID** command on a Trunk port or an Uplink port to enable N:1 VLAN mapping.
- The value of *CVID*, *CVID-LIST*, and *SVID* is within the specified VLAN range.

Command	vlan-mapping-in vlan <i>src-vlan-list</i> remark <i>dest-vlan</i>
Parameter Description	<i>src-vlan-list</i> : Indicates the VLAN list that contains multiple customer VLANs. <i>dest-vlan</i> : Indicates the service VLAN, which is the VLAN where the SP network is located.
Defaults	
Command Mode	Interface configuration mode
Usage Guide	N/A

Verification

Check whether VLAN mapping is configured correctly.

- Run the **show interfaces[*intf-id*] vlan-mapping** command to display the VLAN mapping.

Configuration Example

- ❖ Implementing VLAN Aggregation for Different Services Through VLAN Mapping

<p>Scenario Figure 13-14</p>	
<p>Configuration Steps</p>	<ul style="list-style-type: none"> ● Configure Home Gateway 1 and Home Gateway 2. <p>Step 1: On the home gateways, configure the original VLANs for different services.</p> <pre>Qtech#configure terminal Enter configuration commands, one per line. End with CNTL/Z. Qtech(config)#vlan range 10 12 Qtech(config vlan range)#exit</pre> <p>Step 2: Configure the attributes of the ports connected to PC, IPTV, and VoIP. Assume that the connected ports are Gi 0/2, Gi 0/3, and Gi 0/4 respectively.</p> <pre>Qtech(config)#interface gigabitEthernet 0/2 Qtech(config if GigabitEthernet 0/2)#switchport access vlan 10 Qtech(config if GigabitEthernet 0/2)#exit Qtech(config)#interface gigabitEthernet 0/3 Qtech(config if GigabitEthernet 0/3)#switchport access vlan 11 Qtech(config if GigabitEthernet 0/3)#exit Qtech(config)#interface gigabitEthernet 0/4 Qtech(config if GigabitEthernet 0/4)#switchport access vlan 12 Qtech(config if GigabitEthernet 0/4)#exit</pre> <p>Step 3: Configure an Uplink port.</p> <pre>Qtech(config)# interface gigabitEthernet 0/1</pre>

```
Qtech(config if GigabitEthernet 0/1)#switchport mode uplink
```

- Configure a floor switch with 1:1 VLAN mapping policies.

Step 1: On the home gateways, configure the original VLANs and mapped VLANs for different services.

```
Qtech#configure terminal
```

Enter configuration commands, one per line. End with CNTL/Z.

```
Qtech(config)#vlan range 10 12
```

```
Qtech(config vlan range)#exit
```

```
Qtech(config)#vlan range 100 102
```

```
Qtech(config vlan range)#exit
```

```
Qtech(config)#vlan range 200 202
```

```
Qtech(config vlan range)#exit
```

Step 2: On the Downlink port of Home Gateway 1, configure 1:1 VLAN mapping policies in the inbound and outbound directions.

```
Qtech(config)#interface gigabitEthernet 0/2
```

```
Qtech(config if GigabitEthernet 0/2)#switchport mode uplink
```

```
Qtech(config if GigabitEthernet 0/2)#vlan mapping in vlan 10 remark 100
```

```
Qtech(config if GigabitEthernet 0/2)#vlan mapping in vlan 11 remark 101
```

```
Qtech(config if GigabitEthernet 0/2)#vlan mapping in vlan 12 remark 102
```

```
Qtech(config if GigabitEthernet 0/2)#vlan mapping out vlan 100 remark 10
```

```
Qtech(config if GigabitEthernet 0/2)#vlan mapping out vlan 101 remark 11
```

```
Qtech(config if GigabitEthernet 0/2)#vlan mapping out vlan 102 remark 12
```

Step 3: On the Downlink port of Home Gateway 2, configure 1:1 VLAN mapping policies in the inbound and outbound directions.

```
Qtech(config)#interface gigabitEthernet 0/3
```

```
Qtech(config if GigabitEthernet 0/3)#switchport mode uplink
```

```
Qtech(config if GigabitEthernet 0/3)#vlan mapping in vlan 10 remark 200
```

```
Qtech(config if GigabitEthernet 0/3)#vlan mapping in vlan 11 remark 201
```

```
Qtech(config if GigabitEthernet 0/3)#vlan mapping in vlan 12 remark 202
```

```
Qtech(config if GigabitEthernet 0/3)#vlan mapping out vlan 200 remark 10
```

```
Qtech(config if GigabitEthernet 0/3)#vlan mapping out vlan 201 remark 11
```

```
Qtech(config if GigabitEthernet 0/3)#vlan mapping out vlan 202 remark 12
```

Step 4: Configure an Uplink port.

```
Qtech(config)# interface gigabitEthernet 0/1
Qtech(config if GigabitEthernet 0/1)#switchport mode uplink
```

- Configure a campus switch with N:1 VLAN mapping policies.

Step 1: Configure all VLANs to be used, including the original VLANs and mapped VLANs.

```
Qtech#configure terminal
Enter configuration commands, one per line. End with CNTL/Z.
Qtech(config)#vlan range 100 102
Qtech(config vlan range)#exit
Qtech(config)#vlan range 200 202
Qtech(config vlan range)#exit
Qtech(config)#vlan range 1000 1002
Qtech(config vlan range)#exit
```

Step 2: On the Downlink port, map the VLANs for different services to a VLAN.

```
Qtech(config)#interface gigabitEthernet 0/1
Qtech(config if GigabitEthernet 0/1)#switchport mode uplink
Qtech(config if GigabitEthernet 0/1)#vlan mapping in vlan 100,200 remark
1000
Qtech(config if GigabitEthernet 0/1)#vlan mapping in vlan 101,201 remark
1001
Qtech(config if GigabitEthernet 0/1)#vlan mapping in vlan 102,202 remark
1002
```

Step 3: Configure an Uplink port.

```
Qtech(config)# interface gigabitEthernet 0/2
Qtech(config if GigabitEthernet 0/2)#switchport mode uplink
```

(Optional) Step 4: Enable DHCP snooping.

```
Qtech(config)# ip dhcp snooping
```

(Optional) Step 5: Configure the port connected to the DHCP server as a trusted port.

```
Qtech(config)# interface gigabitEthernet 0/2
Qtech(config if GigabitEthernet 0/2)#ip dhcp snooping trust
```

Verification	Display the 1:1 VLAN mapping policies configured on the floor switch.																																																																	
	<pre>Qtech#show interfaces vlan mapping</pre> <table border="1"> <thead> <tr> <th>Ports</th> <th>type</th> <th>Status</th> <th>Service Vlan</th> <th>Customer Vlan list</th> </tr> </thead> <tbody> <tr><td>Gi0/2</td><td>in</td><td>active</td><td>100</td><td>10</td></tr> <tr><td>Gi0/2</td><td>in</td><td>active</td><td>101</td><td>11</td></tr> <tr><td>Gi0/2</td><td>in</td><td>active</td><td>102</td><td>12</td></tr> <tr><td>Gi0/2</td><td>out</td><td>active</td><td>100</td><td>10</td></tr> <tr><td>Gi0/2</td><td>out</td><td>active</td><td>101</td><td>11</td></tr> <tr><td>Gi0/2</td><td>out</td><td>active</td><td>102</td><td>12</td></tr> <tr><td>Gi0/3</td><td>in</td><td>active</td><td>200</td><td>10</td></tr> <tr><td>Gi0/3</td><td>in</td><td>active</td><td>201</td><td>11</td></tr> <tr><td>Gi0/3</td><td>in</td><td>active</td><td>202</td><td>12</td></tr> <tr><td>Gi0/3</td><td>out</td><td>active</td><td>200</td><td>10</td></tr> <tr><td>Gi0/3</td><td>out</td><td>active</td><td>201</td><td>11</td></tr> <tr><td>Gi0/3</td><td>out</td><td>active</td><td>202</td><td>12</td></tr> </tbody> </table>	Ports	type	Status	Service Vlan	Customer Vlan list	Gi0/2	in	active	100	10	Gi0/2	in	active	101	11	Gi0/2	in	active	102	12	Gi0/2	out	active	100	10	Gi0/2	out	active	101	11	Gi0/2	out	active	102	12	Gi0/3	in	active	200	10	Gi0/3	in	active	201	11	Gi0/3	in	active	202	12	Gi0/3	out	active	200	10	Gi0/3	out	active	201	11	Gi0/3	out	active	202	12
Ports	type	Status	Service Vlan	Customer Vlan list																																																														
Gi0/2	in	active	100	10																																																														
Gi0/2	in	active	101	11																																																														
Gi0/2	in	active	102	12																																																														
Gi0/2	out	active	100	10																																																														
Gi0/2	out	active	101	11																																																														
Gi0/2	out	active	102	12																																																														
Gi0/3	in	active	200	10																																																														
Gi0/3	in	active	201	11																																																														
Gi0/3	in	active	202	12																																																														
Gi0/3	out	active	200	10																																																														
Gi0/3	out	active	201	11																																																														
Gi0/3	out	active	202	12																																																														
	Display the N:1 VLAN mapping policies configured on the campus switch.																																																																	
	<pre>Qtech#show interfaces vlan mapping</pre> <table border="1"> <thead> <tr> <th>Ports</th> <th>type</th> <th>Status</th> <th>Service Vlan</th> <th>Customer Vlan list</th> </tr> </thead> <tbody> <tr><td>Gi0/1</td><td>in</td><td>active</td><td>1000</td><td>100,200</td></tr> <tr><td>Gi0/1</td><td>in</td><td>active</td><td>1001</td><td>101,201</td></tr> <tr><td>Gi0/1</td><td>in</td><td>active</td><td>1002</td><td>102,202</td></tr> </tbody> </table>	Ports	type	Status	Service Vlan	Customer Vlan list	Gi0/1	in	active	1000	100,200	Gi0/1	in	active	1001	101,201	Gi0/1	in	active	1002	102,202																																													
Ports	type	Status	Service Vlan	Customer Vlan list																																																														
Gi0/1	in	active	1000	100,200																																																														
Gi0/1	in	active	1001	101,201																																																														
Gi0/1	in	active	1002	102,202																																																														

13.4.5 Configuring TPIDs

Configurati on Effect

Configure the TPIDs in the tags on SP network devices to realize TPID compatibility.

Notes

If a PE connected to a third-party switch on which the TPID is not 0x8100, you need to configure the TPID on the port of the PE connected to the third-party switch.



- ⚠ Do not set the TPIDs to any of the following values: 0x0806 (ARP), 0x0200 (PUP), 0x8035 (RARP), 0x0800 (IP), 0x86DD (IPv6), 0x8863/0x8864 (PPPoE), 0x8847/0x8848 (MPLS), 0x8137 (IPX/SPX), 0x8000 (IS-IS), 0x8809 (LACP), 0x888E (802.1X), 0x88A7 (clusters), and 0x0789 (reserved by Qtech Networks).

Configurati on Steps

- If a PE connected to a third-party switch on which the TPID is not 0x8100, you need to configure the TPID on the port of the PE connected to the third-party switch.
- TPIDs can be configured in interface configuration mode and global configuration mode. The following example adopts interface configuration mode.

Configure the **frame-tag tpid 0x9100** command in interface configuration mode to change the TPID to 0x9100. For details about the TPID value, see section 1.4.5.

Command	frame-tag tpid tpid
Parameter Description	<i>tpid</i> : Indicates the new value of the TPID.
Defaults	The default value of the TPID is 0x8100.
Command Mode	Interface configuration mode
Usage Guide	If a PE is connected to a third-party switch on which the TPID is not 0x8100, use this command to configure the TPID on the port connected to the third-party switch.

Verification

Check whether the TPID is configured.

Configurati on Example

- ❖ Configuring the TPID on a port

Configuratio n Steps	<p>Configure the TPID on a port.</p> <pre>Qtech(config)# interface gigabitethernet 0/1 Qtech(config if)# frame tag tpid 9100</pre>
Verification	<p>Display the TPID on the port.</p> <pre>Qtech# show frame tag tpid interfaces gigabitethernet 0/1 Port tpid Gi0/1 0x9100</pre>

13.4.6 Configuring MAC Address Replication

Configurati on Effect

- Replicate the dynamic address learned on a port from one VLAN to another.
- Avoid packet floods when service flows are segregated through MAC-based ACLs.

Notes

- i** After MAC address replication is disabled, the system will delete all the learned MAC address entries from the destination VLAN.
- !** MAC address replication can be configured on a port only once. If you need to modify the configuration, delete the current configuration and configure it again.
- !** VLAN MAC address replication cannot be used together with VLAN sharing, and the MAC addresses cannot be replicated to dynamic VLANs.
- !** Up to eight destination VLANs can be configured on each port. MAC address replication takes effect even if the port does not belong to the specified destination VLAN.
- !** MAC address replication cannot be configured on the Host and Promiscuous ports, monitoring ports, and port security-/802.1X-enabled ports.
- !** Only dynamic addresses can be replicated. Address replication is disabled when the address table is full. If source addresses already exist before replication is enabled, corresponding MAC addresses will not be replicated.
- !** Replicated addresses have a higher priority than dynamic addresses but have a lower priority than other types of addresses.
- !** When a MAC address ages, the replicated MAC address will also age. When the MAC address is deleted, the replicated address will be deleted automatically.
- !** Hot backup is not supported. After primary/secondary switchover occurs, it is recommended that you disable MAC address replication and then enable it again.
- i** The MAC address entries obtained through MAC address replication cannot be deleted manually. If you need to delete these entries, disable MAC address replication.

Configurati on Steps

Configuring MAC Address Replication

- Perform this configuration to replicate MAC addresses from one VLAN to another to avoid packet floods.

- Run the **mac-address-mapping <1-8> source-vlan *src-vlan-list* destination-vlan *dst-vlan-id*** command on a Trunk port to enable MAC address replication. *src-vlan-list* and *dst-vlan-id* specify the VLAN range.

Command	mac-address-mapping <i>x</i> source-vlan <i>src-vlan-list</i> destination-vlan <i>dst-vlan-id</i>
Parameter Description	<i>x</i> : Indicates the index number for MAC address replication. The value ranges from 1 to 8. <i>src-vlan-list</i> : Indicates the source VLAN list. <i>dst-vlan-id</i> : Indicates the destination VLAN list.
Defaults	By default, MAC address replication is disabled.
Command Mode	Interface configuration mode
Usage Guide	N/A

Verification

- Check whether the MAC address of the specified VLAN is replicated to another VLAN.

Configuration Example

❖ Configuring MAC Address Replication

Configuration Steps	<ul style="list-style-type: none"> ● Configure MAC address replication. <pre>Qtech(config)# interface gigabitethernet 0/1 Qtech(config if)# switchport mode trunk Qtech(config if)#mac address mapping 1 source vlan 1 3 destination vlan 5</pre>
Verification	<ul style="list-style-type: none"> ● Check whether the configuration takes effect on the port. ● Send a packet from the source VLAN and check whether the source MAC address of the packet is replicated to the destination VLAN. <pre>Qtech# show interfaces mac address mapping Ports destination VID Source VID list ----- Gi0/1 5 1 3</pre>

Common Errors

- See "Notes".

13.4.7 Configuring an Inner/Outer VLAN Tag Modification Policy

Configuration Effect

- Modify outer or inner tags based on the actual networking requirements.

Notes

- ❗ The ACL-based QinQ policy prevails over the port-based and C-TAG-based QinQ policy.
- ❗ When an ACL is deleted, the related policy will be automatically deleted.
- ❗ Tag modification policies take effect only on Access ports, Trunk ports, Hybrid ports, and Uplink ports.
- ❗ Tag modification policies are mainly used to modify inner and outer tags on the SP network.
- ❗ If a packet matches two or more ACL-based selective QinQ policies without priority, only one policy is executed. It is recommended to specify the priority.

Configuration Steps

- ❖ Configuring the Policy to Change the VLAN IDs of Outer Tags Based on Inner Tags
 - Optional.
 - Perform this configuration to change the VLAN IDs of outer tags based on the VLAN IDs of inner tags.
 - You can change the VLAN IDs of the outer tags in the packets that enter Access ports, Trunk ports, Hybrid ports, and Uplink ports based on the VLAN IDs of the inner tags in these packets.

Command	<code>dot1q relay-vid VID translate inner-vid v_list</code>
Parameter	<i>VID</i> : Indicates the modified VLAN ID of the outer tag.
Description	<i>v_list</i> : Indicates the VLAN ID of the inner tag.
Defaults	By default, no policy is configured.
Command Mode	Interface configuration mode
Usage Guide	N/A

- ❖ Configuring the Policy to Change the VLAN IDs of Outer Tags Based on the VLAN IDs of Outer and Inner Tags
 - Optional.
 - Perform this configuration to change the VLAN IDs of outer tags based on the VLAN IDs of inner and outer tags.

- You can change the VLAN IDs of the outer tags in the packets that enter Access ports, Trunk ports, Hybrid ports, and Uplink ports based on the VLAN IDs of the inner and outer tags in these packets.

Command	dot1q new-outer-vlan <i>new-vid</i> translate old-outer-vlan <i>vid</i> inner-vlan <i>v_list</i>
Parameter Description	<i>new-vid</i> : Indicates the modified VLAN ID of the outer tag. <i>vid</i> : Indicates the original VLAN ID of the outer tag. <i>v_list</i> : Indicates the VLAN ID of the inner tag.
Defaults	By default, no policy is configured.
Command Mode	Interface configuration mode
Usage Guide	N/A

❖ Configuring the Policy to Change the VLAN IDs of Outer Tags Based on the Outer Tags

- Optional.
- Perform this configuration to change the VLAN IDs of outer tags based on these VLAN IDs.
- You can change the VLAN IDs of the outer tags in the packets that enter Access ports, Trunk ports, Hybrid ports, and Uplink ports based on these VLAN IDs.

Command	dot1q relay-vid <i>VID</i> translate local-vid <i>v_list</i>
Parameter Description	<i>VID</i> : Indicates the modified VLAN ID of the outer tag. <i>v_list</i> : Indicates the original VLAN ID of the outer tag.
Defaults	By default, no policy is configured.
Command Mode	Interface configuration mode
Usage Guide	N/A

❖ Configuring a Policy to Change the VLAN IDs of Inner Tags Based on ACLs

- Optional.
- You can change the VLAN IDs of the inner tags in the packets that exit Access ports, Trunk ports, Hybrid ports, and Uplink ports based on the packet content.
- Before you configure such a policy, configure an ACL.

Command	traffic-redirect access-group <i>acl</i> inner-vlan <i>vid</i> out
Parameter Description	<i>acl</i> : Indicates the ACL. <i>vid</i> : Indicates the modified VLAN ID of the inner tag.
Defaults	By default, no policy is configured.
Command Mode	Interface configuration mode
Usage Guide	N/A

❖ Configuring a Policy to Change the VLAN IDs of Outer Tags Based on ACLs

- Optional.
- You can change the VLAN IDs of the outer tags in the packets that exit Access ports, Trunk ports, Hybrid ports, and Uplink ports based on the packet content.
- Before you configure such a policy, configure an ACL.

Command	traffic-redirect access-group <i>acl</i> outer-vlan <i>vid</i> in
Parameter	<i>acl</i> : Indicates the ACL.
Description	<i>vid</i> : Indicates the modified VLAN ID of the outer tag.
Defaults	By default, no policy is configured.
Command Mode	Interface configuration mode
Usage Guide	N/A

Verification

Check whether the configuration takes effect and whether the port modifies the tags in received packets based on the policy.

Configuration Example

- ❖ Configuring the Policy to Change the VLAN IDs of Outer Tags Based on the Outer Tags



Configuration Steps	<ul style="list-style-type: none"> ● Configure inner/outer tag modification policies on a port based on the actual networking requirements. ● The following example shows how to change VLAN IDs of outer tags based on outer tags and ACLs respectively. For details about other policies, see the description above. <p>Configure a policy to change outer VLAN tags based on the outer VLAN tags.</p> <pre>Qtech(config)# interface gigabitEthernet 0/1 Qtech(config if)# switchport mode trunk Qtech(config if)# dot1q relay vid 100 translate local vid 10 20</pre> <p>Configure a policy to change outer VLAN tags based on ACLs.</p> <pre>Qtech# configure terminal Qtech(config)# ip access list standard 2 Qtech(config acl std)# permit host 1.1.1.1 Qtech(config acl std)# exit Qtech(config)# interface gigabitEthernet 0/2 Qtech(config if)# switchport mode trunk Qtech(config if)# traffic redirect access group 2 outer vlan 3 in</pre>
Verification	<ul style="list-style-type: none"> ● Check whether the configuration takes effect on the port. ● Check whether the port changes the VLAN IDs of the outer tags in received packets based on the configured policy.

13.4.8 Configuring Priority Mapping and Priority Replication

Configuration Effect

- If an SP network provides a QoS policy based on the User Priority field of the inner tag, configure priority replication to apply the QoS policy to the outer tag.
- If an SP network provides a QoS policy based on the User Priority field of the inner tag, configure priority mapping to apply the User Priority field provided by the SP network to the outer tag.

Notes

- ⚠ Only a Tunnel port can be configured with priority replication, which has a higher priority than trusted QoS but lower than ACL-based QoS.
- ⚠ Priority replication and priority mapping cannot be both enabled on one port.



- ⚠ Only a Tunnel port can be configured with priority mapping, which prevails over QoS.
- ⚠ The configuration of priority mapping does not take effect if no trust mode is configured (trust none) or the trust mode is not matched with priority mapping.

Configuration Steps

- Only a Tunnel port can be configured with priority mapping or priority replication.
- Configure priority replication to apply the inner tag-based QoS policy provided by the SP network.
- Configure priority mapping to configure the User Priority field of the outer VLAN tag based on the inner tag and apply the QoS policy flexibly.
- To enable priority replication, run the **inner-priority-trust enable** command on the Tunnel port.
- To enable priority mapping, run the **dot1q-Tunnel cos inner-cos-value remark-cos outer-cos-value** command on the Tunnel port.

inner-cos-value and *outer-cos-value* range from 0 to 7.

- ℹ The following priority mapping is used when no priority mapping is configured:

inner pri	0	1	2	3	4	5	6	7
outer pri	0	1	2	3	4	5	6	7

Command	inner-priority-trust enable
Parameter Description	N/A
Defaults	By default, priority replication is disabled.
Command Mode	Interface configuration mode
Usage Guide	N/A

Command	dot1q-Tunnel cos inner-cos-value remark-cos outer-cos-value
Parameter Description	<i>inner-cos-value</i> : Indicates the CoS value of the inner tag. <i>outer-cos-value</i> : Indicates the CoS value of the outer tag.
Defaults	By default, priority mapping is disabled.
Command Mode	Interface configuration mode
Usage Guide	N/A

Verification

- Run the **show inner-priority-trust interfaces type intf-id** command and the **show interfaces type intf-id remark** command to check whether priority mapping or priority replication takes effect.

Configuration Example

❖ Configuring Priority Mapping and Priority Replication

Configuration Steps	<ul style="list-style-type: none">● To maintain the packet priority, you need to replicate the priority of the inner tag in a packet to the outer tag on the Tunnel port.● To flexibly control the packet priority on the Tunnel port, you can add outer tags of different priorities to packets based on the priorities of the inner tags in the packets. <p>Configure priority replication.</p> <pre>Qtech(config)# interface gigabitethernet 0/1 Qtech(config if)#mls qos trust cos Qtech(config if)# inner priority trust enable Qtech(config)# end</pre> <p>Configure priority mapping.</p> <pre>Qtech(config)# interface gigabitethernet 0/2 Qtech(config if)#dot1q Tunnel cos 3 remark cos 5</pre>
----------------------------	--

Verification

- Display the priority configuration on the port.

Check whether priority replication is enabled on the Tunnel port.

```
Qtech# show inner priority trust interfaces gigabitethernet 0/1
Port    inner priority trust

Gi0/1   enable
```

Display the priority mapping configured on the Tunnel port.

```
Qtech# show interfaces gigabitethernet 0/1 remark
Ports          Type          From value  To value

Gi0/1          Cos To Cos    3           5
```

Common**Errors**

See "Notes".

13.4.9 Configuring Layer-2 Transparent Transmission**Configurati
on Effect**

Transmit Layer-2 packets transparently without impact on the SP network and the customer network.

Notes

- ⚠ If STP is not enabled, you need to run the **bridge-frame forwarding protocol bpdu** command to enable STP transparent transmission.
- ⚠ Transparent transmission enabled on a port takes effect only after enabled globally. When transparent transmission takes effect on the port, the port does not participate in related protocol calculation. If the port receives a packet whose destination MAC address is the special broadcast address, it determines that a networking error occurs and discards the packet.

**Configurati
on Steps**

- ❖ Configuring STP Transparent Transmission
 - Mandatory if you need to transparently transmit BPDU packets through STP.

- Enable STP transparent transmission in global configuration mode and interface configuration mode.
- Run the **I2protocol-tunnel stp** command in global configuration mode to enable STP transparent transmission.
- Run the **I2protocol-tunnel stp enable** command in interface configuration mode to enable STP transparent transmission.

Command	I2protocol-tunnel stp
Parameter Description	N/A
Defaults	By default, STP transparent transmission is disabled.
Command Mode	Global configuration mode
Usage Guide	N/A

Command	I2protocol-tunnel stp enable
Parameter Description	N/A
Defaults	By default, STP transparent transmission is disabled.
Command Mode	Interface configuration mode
Usage Guide	N/A

❖ Configuring GVRP Transparent Transmission

- Mandatory if you need to transparently transmit GVRP packets.
- Enable GVRP transparent transmission in global configuration mode and interface configuration mode.
- Run the **I2protocol-tunnel gvrp** command in global configuration mode to enable GVRP transparent transmission.
- Run the **I2protocol-tunnel gvrp enable** command in interface configuration mode to enable GVRP transparent transmission.

Command	I2protocol-tunnel gvrp
Parameter Description	N/A
Defaults	By default, GVRP transparent transmission is disabled.
Command Mode	Global configuration mode
Usage Guide	N/A

Command	<code>l2protocol-tunnel gvrp enable</code>
Parameter Description	N/A
Defaults	By default, GVRP transparent transmission is disabled.
Command Mode	Interface configuration mode
Usage Guide	N/A

❖ Configuring a Transparent Transmission Address

- Optional.
- Configure a transparent transmission address.

Command	<code>l2protocol-tunnel { stp gvrp } tunnel-dmac mac-address</code>
Parameter Description	<i>mac-address</i> : Indicates the address used to transparently transmit packets.
Defaults	By default, the first three bytes of the transparent transmission address is 08c6b3, and the last three bytes are 000005 and 000006 for STP and GVTP respectively.
Command Mode	Interface configuration mode
Usage Guide	<p>i The following addresses are available for STP: 08c6.b300.0005, 011a.a900.0005, 010f.e200.0003, 0100.0ccd.cdd0, 0100.0ccd.cdd1, and 0100.0ccd.cdd2. The following addresses are available for GVRP: 08c6.b300.0006 and 011a.a900.0006.</p> <p>i When no transparent transmission address is configured, the default settings are used.</p>

Verification

Run the **show l2protocol-tunnel stp** command and the **show l2protocol-tunnel gvrp** command to check whether the transparent transmission address is configured correctly.

Configuration Example

The following example shows how to configure STP transparent transmission.

Configuring STP Transparent Transmission

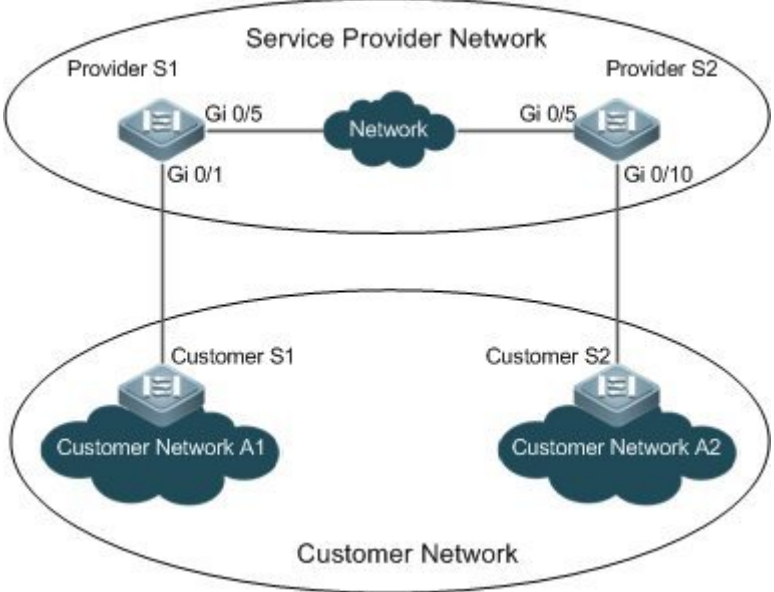
<p>Scenario Figure 13-15</p>	
<p>Configuration Steps</p>	<ul style="list-style-type: none"> ➤ On the PEs (Provider S1 and Provider S2), enable STP transparent transmission in global configuration mode and interface configuration mode. ➤ Before you enable STP transparent transmission, enable STP in global configuration mode to allow the switches to forward STP packets.
<p>Provider S1</p>	<p>Step 1: Enable STP.</p> <pre>bridge frame forwarding protocol bpdu</pre> <p>Step 2: Configure the VLAN for transparent transmission.</p> <pre>ProviderS1#configure terminal Enter configuration commands, one per line. End with CNTL/Z. ProviderS1(config)#vlan 200 ProviderS1(config vlan)#exit</pre> <p>Step 3: Enable basic QinQ on the port connected to the customer network and use VLAN 200 for tunneling.</p> <pre>ProviderS1(config)#interface gigabitEthernet 0/1 ProviderS1(config if GigabitEthernet 0/1)#switchport mode dot1q tunnel ProviderS1(config if GigabitEthernet 0/1)#switchport dot1q tunnel native vlan 200</pre> <p>Step 4: Enable STP transparent transmission on the port connected to the customer network.</p> <pre>ProviderS1(config if GigabitEthernet 0/1)#l2protocol tunnel stp enable ProviderS1(config if GigabitEthernet 0/1)#exit</pre>

	<p>Step 5: Enable STP transparent transmission in global configuration mode.</p> <pre>ProviderS1(config)#l2protocol tunnel stp</pre> <p>Step 4: Configure an Uplink port.</p> <pre>ProviderS1(config)# interface gigabitEthernet 0/5 ProviderS1(config if GigabitEthernet 0/5)#switchport mode uplink</pre>
Provider S2	<p>Configure Provider S2 by performing the same steps.</p>
Verification	<p>Step 1: Check whether STP transparent transmission is enabled in global configuration mode and interface configuration mode.</p> <pre>ProviderS1#show l2protocol tunnel stp</pre> <pre>L2protocol tunnel: Stp Enable GigabitEthernet 0/1 l2protocol tunnel stp enable</pre> <p>Step 2: Verify the configuration by checking whether:</p> <ul style="list-style-type: none"> ● The port type is dot1q-tunnel. ● The outer tag VLAN is consistent with the native VLAN and added to the VLAN list of the Tunnel port. ● The port that accesses the SP network is configured as an Uplink port. <pre>ProviderS1#show running config interface GigabitEthernet 0/1 switchport mode dot1q tunnel switchport dot1q tunnel allowed vlan add untagged 200 switchport dot1q tunnel native vlan 200 l2protocol tunnel stp enable spanning tree bpdufilter enable ! interface GigabitEthernet 0/5 switchport mode uplink</pre>

Common Errors

- STP is not enabled in global configuration mode.

- Transparent transmission is not enabled in global configuration mode and interface configuration mode.

13.5 Monitoring

Displaying

Description	Command
Displays whether the specified port is a Tunnel port.	show dot1q-tunnel [interfaces <i>intf-id</i>]
Displays the configuration of the Tunnel port.	show interfaces dot1q-tunnel
Displays the C-TAG-based selective QinQ policies on the Tunnel port.	show registration-table [interfaces <i>intf-id</i>]
Displays the C-TAG-based selective QinQ policies on the Access port, Trunk port or Hybrid port.	show translation-table [interfaces <i>intf-id</i>]
Displays VLAN mapping on ports.	show interfaces [<i>intf-id</i>] vlan-mapping
Displays the ACL-based selective QinQ policies.	show traffic-redirect [interfaces <i>intf-id</i>]
Displays the TPID configuration on ports.	show frame-tag tpid interfaces [<i>intf-id</i>]
Displays the configuration of priority replication.	show inner-priority-trust
Displays the configuration of priority mapping.	show interface intf-name remark
Displays the configuration of MAC address replication.	show mac-address-mapping
Displays the configuration of Layer-2 transparent transmission.	show l2protocol-tunnel { gvrp stp }

Debugging

- ⚠** System resources are occupied when debugging information is output. Therefore, disable debugging immediately after use.

Description	Command
Debugs QinQ.	debug bridge qinq

14. CONFIGURING MGMT

14.1 Overview

Due to limits of internal composition, the Ethernet interface on the panel of our product is separated from forwarding parts inside the device, and has no functions of the forwarding panel and control panel. Accordingly, communication on such Ethernet interface is also separated from service communication running on the device, which is called as "out-of-band communications". The Ethernet interface can be used to manage the device in a similar way when the device is logged in through the Console interface. The management Ethernet interface, customarily called as MGMT interface, is only used to manage the device, but does not support communication forwarding.

You can use the MGMT interface to separate the management network from the service network, so as to avoid interference from the traffic and communication state of the service network and improve management reliability. In particular, when the service network has a fault, you can still use the management network to manage the device. Compared with the in-band management method of the service network, such an advantage is incomparable.

In addition, compared with the Console interface, the MGMT interface has a larger bandwidth (for example, 100 MB vs 115,200 bps). In a management network with a log server, the MGMT interface can be used to send logs to the log server, so that the sending and storage of logs are also not affected by the communication state of the service network.

- Due to different hardware components, the MGMT interface may be a FastEthernet (FE) or GigabitEthernet (GE) interface.
- The following section describes the configuration of the Ethernet interface for management.

14.2 Applications

Application	Description
Network Management Tool	The MGMT interface is used to manage and debug the network communication.
File Management	The MGMT interface is used for file copy between the management network and the device.
Network Login Management	The MGMT interface is used to remotely log in to another device or host from the local device.
MIB Management	The MGMT interface is used to send an SNMP trap message to the NMS server.
Log Management	The MGMT interface is used to send a log message to the Syslog server.

14.2.1 Network Management Tool

Scenario

Figure 14-1 Network Management Tool

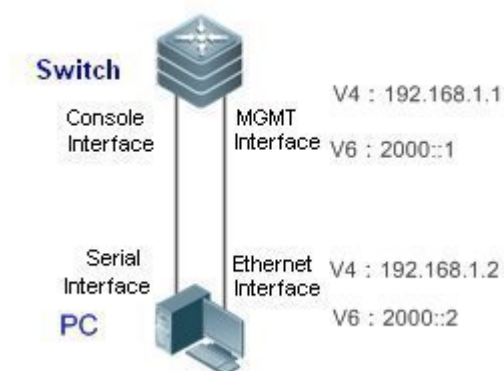

As shown in Figure 14-1, the serial interface of PC is connected to the Console interface of the switch, so as to configure the Layer-3 interface attribute and Layer-2 interface attribute for the MGMT interface, detect reachable hosts of the MGMT interface, and trace the routes of these reachable hosts.

Deployment

- Connect the serial interface of PC to the Console interface of the switch.
- Connect the Ethernet interface of PC to the MGMT interface of the switch.
- Use the serial interface of PC to configure the MGMT interface of the switch.
- Use the serial interface of PC to send a command of detecting reachable hosts of the MGMT interface.
- Use the serial interface of PC to send a command of tracing routes of reachable hosts of the MGMT interface.

14.2.2 File Management

Scenario

Figure 14-2 File Management

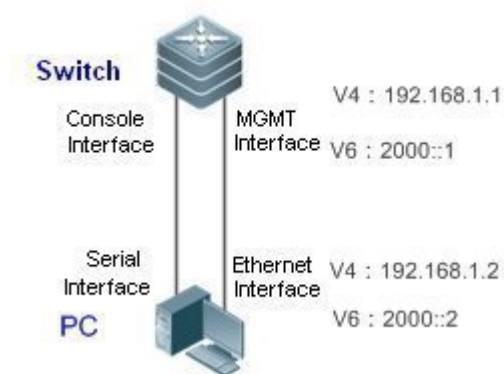

As shown in Figure 14-2, the serial interface of PC is connected to the Console interface of the switch, so as to configure the Layer-3 interface attribute and Layer-2 interface attribute for the MGMT interface. The switch uses the MGMT interface to copy a file from the file server.

Remarks	-
---------	---

Deployment

- Connect the serial interface of PC to the Console interface of the switch.
- Connect the Ethernet interface of PC to the MGMT interface of the switch.
- Use the serial interface of PC to configure the MGMT interface of the switch.
- Enable the file server on PC.
- Use the serial port of PC to send a command that the switch uses the MGMT interface to copy a file from the file server.

14.2.3 Network Login Management

Scenario

Figure 14-3 Network Login Management

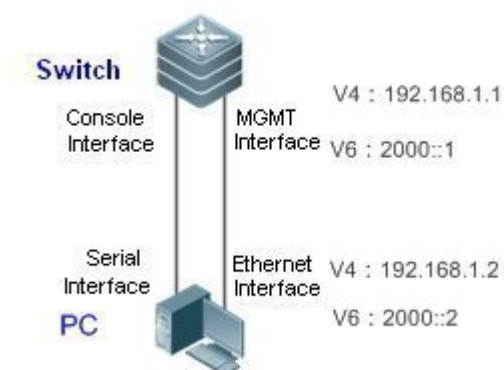

As shown in Figure 14-2Figure 14-3, the serial interface of PC is connected to the Console interface of the switch, so as to configure the Layer-3 interface attribute and Layer-2 interface attribute for the MGMT interface. The switch uses the MGMT interface to log in to the Telnet server of PC.

Remark	-
s	

Deploymen

t

- Connect the serial interface of PC to the Console interface of the switch.
- Connect the Ethernet interface of PC to the MGMT interface of the switch.
- Use the serial interface of PC to configure the MGMT interface of the switch.
- Enable the Telnet server on PC.
- Use the serial port of PC to send a command that the switch uses the MGMT interface to log in to the Telnet server of PC.

14.2.4 MIB Management

Scenario

Figure 14-4 MIB Management

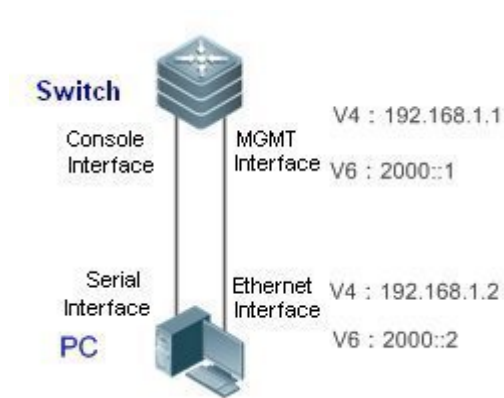

As shown in Figure 14-4, the serial interface of PC is connected to the Console interface of the switch, so as to configure the Layer-3 interface attribute and Layer-2 interface attribute for the MGMT interface. The switch uses the MGMT interface to send an SNMP trap message to the NMS server of PC.

Deploymen

t

- Connect the serial interface of PC to the Console interface of the switch.

- Connect the Ethernet interface of PC to the MGMT interface of the switch.
- Use the serial interface of PC to configure the MGMT interface of the switch.
- Enable the NMS server on PC.
- Use the serial port of PC to send a command that the switch uses the MGMT interface to send an SNMP trap message to the NMS server of PC.

14.2.5 Log Management

Scenario

Figure 14-5 Log Management

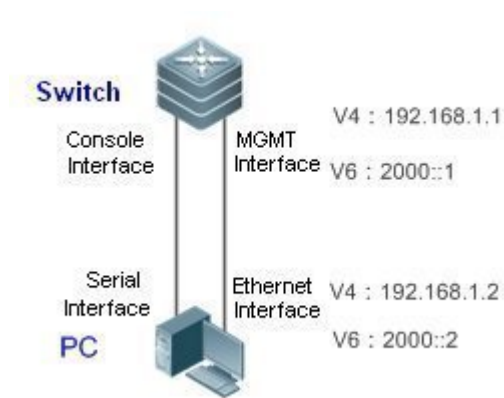

As shown in Figure 14-5, the serial interface of PC is connected to the Console interface of the switch, so as to configure the Layer-3 interface attribute and Layer-2 interface attribute for the MGMT interface. The switch uses the MGMT interface to send a log message to the Syslog server of PC.

Remark	-
s	

Deployment

- Connect the serial interface of PC to the Console interface of the switch.
- Connect the Ethernet interface of PC to the MGMT interface of the switch.
- Use the serial interface of PC to configure the MGMT interface of the switch.
- Enable the Syslog server on PC.
- Use the serial port of PC to send a command that the switch uses the MGMT interface to send a log message to the Syslog server of PC.

14.3 Features

Overview

Feature	Description
Interface Attribute Management	In terms of network communication, the MGMT interface is not substantially different from other LAN interfaces. The only difference lies in that, the MGMT interface does not support communication forwarding, and thus its configurable items are fewer than other LAN interfaces. Certain commands shall particularly specify that the MGMT interface is used for out-of-band communication.
Network Management Tool	For convenient management and debugging of communications on the network, the system provides some command tools that use the MGMT interface for network management.
File Management	The system allows a user to use the MGMT interface to copy files between the management network and the device.
Network Login Management	The system allows a user to use the MGMT interface of the local device to remotely log in to other devices or hosts.
MIB Management	For convenient MIB management, the system provides allows a user to use the MGMT interface to send an SNMP trap message to the NMS server.
Log Management	For convenient log management, the system allows a user to use the MGMT interface to send a log message to the Syslog server.

14.3.1 Interface Attribute Management

Working Principle

In terms of network communication, the MGMT interface is not substantially different from other LAN interfaces. Therefore, you can configure the attributes of the MGMT interface, so as to enable the MGMT interface with the network communication function similar to a common LAN interface. It should be noted that the MGMT interface does not support communication forwarding.

Related Configuration

- ❖ Configuring the IPv4 address of the MGMT interface

By default, the MGMT interface has no IPv4 address. In the MGMT interface mode, you can run the command below to configure the IPv4 address of the MGMT interface.

```
ip address address mask
```

Wherein, *address* indicates **an IPv4 address**, and *mask* indicates **an IPv4 address mask**.

- ❖ Configuring the IPv4 gateway of the MGMT interface

By default, the MGMT interface has no IPv4 gateway. In the MGMT interface mode, you can run the command below to configure the IPv4 gateway of the MGMT interface.

gateway *A.B.C.D*

Wherein, *A.B.C.D* indicates the **IPv4 gateway address**.

- ❖ Configuring the IPv6 address of the MGMT interface

By default, the MGMT interface has no IPv6 address and the subnet mask. In the MGMT interface mode, you can run the command below to configure the IPv6 address of the MGMT interface.

ipv6 address *ipv6-address/prefix-length*

Wherein, *ipv6-address* indicates an **IPv6 address**, and *prefix-length* indicates the prefix length of the IPv6 address mask.

- ❖ Configuring the IPv6 gateway of the MGMT interface

By default, the MGMT interface has no IPv6 gateway. In the MGMT interface mode, you can run the command below to configure the IPv6 gateway of the MGMT interface.

ipv6 gateway *ipv6-address*

Wherein, *ipv6-address* indicates an **IPv6 gateway address**.

- ❖ Configuring the MTU of the MGMT interface

By default, the MTU value of the MGMT interface is 1,500. You can run the command below to configure the MTU of the MGMT interface.

MTU *mtu-value*

Wherein, *mtu-value* indicates an **MTU value**. The value ranges from 64 to the maximum MTU value supported by the device.

- ❖ Configuring the speed mode of the MGMT interface

By default, the speed mode of the MGMT interface is auto. You can run the command below to configure the speed mode of the MGMT interface.

speed {**10** | **100** | **1000** | **auto**}

- ❖ Configuring the duplex mode of the MGMT interface

By default, the duplex mode of the MGMT interface is auto. You can run the command below to configure the duplex mode of the MGMT interface.

duplex {**full** | **half** | **auto**}

- ❖ Configuring the descriptor of the MGMT interface

By default, the MGMT interface has no interface descriptor. You can run the command below to configure the interface descriptor of the MGMT interface.



description text

Wherein, *text* indicates an interface descriptor.

❖ Disabling the MGMT interface

By default, the MGMT interface is enabled. You can run the command below to disable the MGMT interface.

shutdown**14.3.2 Network Management Tool**

For convenient management and debugging of communications on the network, the system provides some command tools that use the MGMT interface for network management.

Working**Principle**

- The system uses the MGMT interface to send a ping packet to detect reachability of the IPv4/IPv6 addresses of a node/host on a management network.
- The system uses the MGMT interface to send a traceroute packet to detect the IPv4/IPv6 routes of a node/host on a management network.

Related**Configurati
on**

❖ Detecting reachability of an IPv4 address

In the privileged mode, the command below is used to detect reachability of an IPv4 address of a node/host via the MGMT interface.

ping oob address via mgmt-name

Wherein, *address* indicates the IPv4 address of the node/host detected, and *mgmt-name* indicates the packet egress management interface in the oob mode.

❖ Tracing an IPv4 route

In the privileged mode, the command below is used to trace the IPv4 route of a node/host via the MGMT interface.

traceroute oob address via mgmt-name

Wherein, *address* indicates the IPv4 address of the node/host traced.

❖ Detecting reachability of an IPv6 address

In the privileged mode, the command below is used to detect reachability of an IPv6 address of a node/host via the MGMT interface.

ping oob ipv6 *ipv6-address* via *mgmt-name*

Wherein, *ipv6-address* indicates the IPv6 address of the node/host detected.

❖ Tracing an IPv6 route

In the privileged mode, the command below is used to trace the IPv6 route of a node/host via the MGMT interface.

```
traceroute oob ipv6 ipv6-address via mgmt-name
```

Wherein, *ipv6-address* indicates the IPv6 address of the node/host traced, and *mgmt-name* indicates the packet egress management interface in the oob mode.

14.3.3 File Management

The system allows a user to use the MGMT interface to copy files between the management network and the device.

Working Principle

Copy a specified file from the source URL to the destination URL via the MGMT interface.

Related Configuration

❖ Copying files

In the privileged mode, the command below is used to copy a specified file from the source URL to the destination URL via the MGMT interface.

```
❖ copy oob_tftp://source-url destination-url
```

Wherein, *source-url* indicates the file source URL, and *destination-url* indicates the file destination URL.

14.3.4 Network Login Management

The system allows a user to use the MGMT interface of the local device to remotely log in to other devices or hosts.

Working Principle

Log in to a specified device node/host via the MGMT interface to remotely control the device node.

Related Configurati on

❖ Network login management

In the privileged mode, the command below is used to log in to a specified device node/host via the MGMT interface.

```
telnet oob ip-address | ipv6-address
```

Wherein, *ip-address* indicates the IPv4 address of the device node/host, and *ipv6-address* indicates the IPv6 address of the device node/host.

14.3.5 MIB Management

For convenient MIB management, the system allows a user to use the MGMT interface to send a trap message to the NMS server.

Working Principle

Send an SNMP trap message to the NMS server via the MGMT interface and the IPv4/IPv6 address of the NMS server.

Related Configurati on

❖ Sending a trap message to the IPv4 address of the NMS server

In the global mode, the command below is used to send a trap message to the IPv4 address of the NMS server via the MGMT interface. This function is disabled by default.

```
snmp-server host oob ip-address
```

Wherein, *ip-address* indicates the IPv4 address of the NMS server.

❖ Sending a trap message to the IPv6 address of the NMS server

In the privileged mode, the command below is used to send a trap message to the IPv6 address of the NMS server via the MGMT interface. This function is disabled by default.

```
snmp-server host oob ipv6 ipv6-address
```

Wherein, *ipv6-address* indicates the IPv6 address of the NMS server.

14.3.6 Log Management

For convenient log management, the system allows a user to use the MGMT interface to send a log message to the Syslog server.

Working Principle

Send a log message to the Syslog server via the MGMT interface and the IPv4/IPv6 address of the Syslog server.

Related Configuration

- ❖ Sending a log message via the MGMT interface and the IPv4 address of the Syslog server

In the global mode, the command below is used to send a log message to the Syslog server via the MGMT interface and the IPv4 address of the Syslog server. This function is disabled by default.

logging server oob ip-address

Wherein, ip-address indicates the IPv4 address of the Syslog server.

- ❖ Sending a log message via the MGMT interface and the IPv6 address of the Syslog server

In the privileged mode, the command below is used to send a log message to the Syslog server via the MGMT interface and the IPv6 address of the Syslog server. This function is disabled by default.

logging server oob ipv6 ipv6-address

Wherein, ipv6-address indicates the IPv6 address of the Syslog server.

14.4 Configuration

Configuration	Description and Command
Interface Attribute Management	<p>The IPv4 and IPv6 addresses of the MGMT interface must be configured. You can configure the IPv4/IPv6 addresses to manage the device via the MGMT interface.</p>
	<p>ip address <i>address mask</i></p> <p>It is used to configure the IPv4 address and subnet mask of the MGMT interface.</p>
	<p>ipv6 address <i>ipv6-address/prefix-length</i></p> <p>It is used to configure the IPv6 address and subnet mask of the MGMT interface.</p>
	<p>gateway <i>A.B.C.D</i></p> <p>It is used to configure the gateway of the IPv4 management network.</p>
	<p>ipv6 gateway <i>ipv6-address</i></p> <p>It is used to configure the gateway of the IPv6 management network.</p>
	<p>(Optional) It is used to make the MGMT interface work in the best status according to the needs of network deployment.</p>

Configuration	Description and Command	
	mtu <i>mtu-value</i>	Configures the MTU value of the MGMT interface.
	speed { 10 100 1000 auto }	Configures the speed mode of the MGMT interface. The default value is auto.
	duplex { full half auto }	Configures the duplex mode of the MGMT interface. The default value is auto.
	shutdown	Disables the MGMT interface
	description <i>text</i>	Configures the descriptor.
Network Management Tool	(Optional)It is used to manage the network via the MGMT interface, for example, performing the ping operation or tracing the network route, so as to detect the reachability and route information of the network host.	
	ping oob <i>address</i>	ICMP echo request to detect the reachability of hosts on the management network.
	ping oob ipv6 <i>ipv6-address</i>	ICMPv6 echo request to detect the reachability of hosts on the management network.
	traceroute oob <i>address</i>	It is used to detect routes to hosts on the management network.
	traceroute oob ipv6 <i>ipv6-address</i>	It is used to detect routes to IPv6 hosts on the management network.
File Management	(Optional)It is used to copy files between the management network and the device via the MGMT interface.	
	copy oob_tftp :// <i>source-url</i> <i>destination-url</i>	It is used to copy a file from a position specified by <i>source-url</i> to a position specified by <i>destination-url</i> .
Network Login Management	(Optional)It is used to remotely log in to other devices or hosts via the MGMT interface.	
	telnet oob <i>ip-address</i> <i>ipv6-address</i>	This command is used to execute a telnet command on the device and perform data interaction via the MGMT interface. During configuration, it does not need to specify such parameters as ip and ipv6 to specify which protocol (IPv4/IPv6) is to be used, because the system automatically determines the input address is a valid IPv4 or IPv6 address.

Configuration	Description and Command	
MIB Management	(optional)It is used to send an SNMP trap message to the NMS server via the MGMT interface.	
	snmp-server host oob ip-address	Configures the SNMP agent to specify that a trap message is sent to the IPv4 address of the NMS server via the MGMT interface.
	snmp-server host oob ipv6 ipv6-address	Configures the SNMP agent to specify that a trap message is sent to the IPv6 address of the NMS server via the MGMT interface.
Log Management	(Optional)It is used to send a log message to the Syslog server via the MGMT interface.	
	logging server oob ip-address	Configures Syslog to specify that a log message is sent to the IPv4 address of the Syslog server via the MGMT interface.
	logging server oob ipv6 ipv6-address	Configures Syslog to specify that a log message is sent to the IPv6 address of the Syslog server via the MGMT interface.

14.4.1 Interface Attribute Management

[Configuration Effect](#)

- Configure a Layer-3 address of the MGMT interface
- Configure the gateway address of the management network.
- Configure the physical attributes of the MGMT interface.
- After configuration, the MGMT interface can be used for device management.

[Notes](#)

- The MGMT interface does not support communication forwarding.

[Configuration Steps](#)

- ❖ Configuring a Layer-3 address of the MGMT interface
 - Enter the interface configuration mode of the MGMT interface.
 - Configure a Layer-3 address of the MGMT interface.
- ❖ Configuring the gateway address of the management network

- Enter the interface configuration mode of the MGMT interface.
- Configure the gateway address of the management network.

Verification

- Run **show running** to display the configuration.

Related

Commands

❖ Configuring the IPv4 address of the MGMT interface

Command	ip address <i>address mask</i>
Parameter	<i>address</i> : Indicates an IPv4 address.
Description	<i>Mask</i> : Indicates an IPv4 address mask.
Command Mode	MGMT interface mode.
Usage Guide	-

❖ Configuring the IPv4 gateway of the management network

Command	gateway <i>A.B.C.D</i>
Parameter	<i>A.B.C.D</i> : Indicates an IPv4 gateway address.
Description	
Command Mode	MGMT interface mode.
Usage Guide	-

❖ Configuring the IPv6 address of the MGMT interface

Command	ipv6 address <i>ipv6-address/prefix-length</i>
Parameter	<i>ip-address</i> : Indicates an IPv6 address.
Description	<i>prefix-length</i> : Indicates the prefix length of the IPv4 address mask.
Command Mode	MGMT interface mode.
Usage Guide	-

❖ Configuring the IPv6 gateway of the management network

Command	ipv6 gateway <i>ipv6-address</i>
Parameter	<i>ip-address</i> : Indicates the IPv6 gateway address.
Description	
Command Mode	MGMT interface mode.
Usage Guide	-

❖ Configuring the MTU of the MGMT interface



Command	
Parameter Description	<i>mtu-value</i> : Indicates the MTU value of the MGMT interface.
Command Mode	MGMT interface mode.
Usage Guide	-

❖ Configuring the speed mode of the MGMT interface

Command	speed {10 100 1000 auto}
Parameter Description	The default value is auto.
Command Mode	MGMT interface mode.
Usage Guide	-

❖ Configuring the duplex mode of the MGMT interface

Command	duplex {full half auto}
Parameter Description	The default value is auto.
Command Mode	MGMT interface mode.
Usage Guide	-

❖ Configuring the descriptor of the MGMT interface

Command	description <i>text</i>
Parameter Description	<i>text</i> : Indicates a descriptor of the interface. No default value is available.
Command Mode	MGMT interface mode.
Usage Guide	-

❖ Disabling the MGMT interface

Command	shutdown
Parameter Description	The default value is <i>no shutdown</i> .
Command Mode	MGMT interface mode.
Usage Guide	-

[Configurati on Example](#)

❖ Configuring the MGMT interface

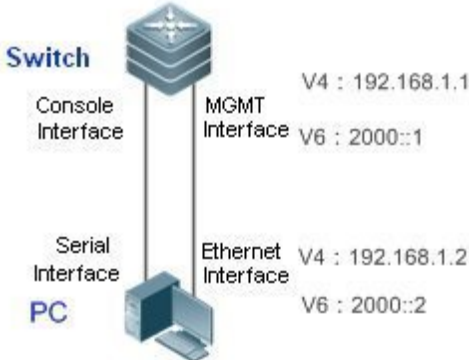
<p>Scenario Figure 14-6</p>	
<p>Configuration Steps</p>	<ul style="list-style-type: none"> ➤ Connect the serial interface of PC to the Console interface of the switch. ➤ Configure the Layer-3 IPv4 address of the MGMT interface on the switch to 192.168.1.1. ➤ Configure the IPv4 gateway address of the management network to 192.168.1.2. ➤ Configure the Layer-3 IPv6 address of the MGMT interface on the switch to 2000::1. ➤ Configure the IPv6 gateway address of the management network to 2000::2. ➤ Configure the speed of the MGMT interface on the switch to 1,000 MB. ➤ Disable the MGMT interface on the switch.
<p>Switch</p>	<pre>Qtech# configure Qtech(config)# interface mgmt 0 Qtech(config if Mgmt 0)# ip address 192.168.1.1 255.255.255.0 Qtech(config if Mgmt 0)# gateway 192.168.1.1 Qtech(config if Mgmt 0)# ipv6 address 2000::1/64 Qtech(config if Mgmt 0)# gateway 2000::2 Qtech(config if Mgmt 0)# speed 1000 Qtech(config if Mgmt 0)# shutdown</pre>
<p>Verification</p>	<ul style="list-style-type: none"> ➤ Run the show running command to check the above configurations on the switch.
<p>Switch</p>	<pre>Qtech# show run int mgmt 0 Building configuration... Current configuration : 168 bytes ! interface MGMT 0 no switchport</pre>

```
speed 1000
no ip proxy arp
ip address 192.168.1.1 255.255.255.0
ipv6 address 2000::1/64
ipv6 enable
gateway 192.168.1.1
ipv6 gateway 2000::2
shutdown
```

14.4.2 Network Management Tool

Configurations on Effect

- Detect reachability of the IPv4 address of a device node/host via the MGMT interface.
- Trace the IPv4 route of a device node/host via the MGMT interface.
- Detect reachability of the IPv6 address of a device node/host via the MGMT interface.
- Trace the IPv6 route of a device node/host via the MGMT interface.

Configurations on Steps

- ❖ Detecting reachability of an IPv4 address
 - Enter the privileged mode.
 - Detect reachability of the IPv4 address of a device node/host via the MGMT interface.
- ❖ Tracing an IPv4 route
 - Enter the privileged mode.
 - Trace the IPv4 route of a device node/host via the MGMT interface.
- ❖ Detecting reachability of an IPv6 address
 - Enter the privileged mode.
 - Detect reachability of the IPv6 address of a device node/host via the MGMT interface.
- ❖ Tracing an IPv6 route
 - Enter the privileged mode.
 - Trace the IPv6 route of a device node/host via the MGMT interface.

Verification

- View the real-time process.

Related Commands

❖ Detecting reachability of an IPv4 address

Command	ping oob address via mgmt-name
Parameter	<i>address</i> : Indicates an IPv4 address.
Description	<i>mgmt-name</i> : Specifies the packet egress management interface in the oob mode.
Command Mode	Privileged mode
Usage Guide	-

❖ Tracing an IPv4 route

Command	traceroute oob address via mgmt-name
Parameter	<i>address</i> : Indicates an IPv4 address.
Description	<i>mgmt-name</i> : Specifies the packet egress management interface in the oob mode.
Command Mode	Privileged mode
Usage Guide	-

❖ Detecting reachability of an IPv6 address

Command	ping oob ipv6 ipv6-address via mgmt-name
Parameter	<i>ip-address</i> : Indicates an IPv6 address.
Description	<i>mgmt-name</i> : Specifies the packet egress management interface in the oob mode.
Command Mode	Privileged mode
Usage Guide	-

❖ Tracing an IPv6 route

Command	traceroute oob ipv6 ipv6-address via mgmt-name
Parameter	<i>ip-address</i> : Indicates an IPv6 address.
Description	<i>mgmt-name</i> : Specifies the packet egress management interface in the oob mode.
Command Mode	Privileged mode
Usage Guide	-

Configurati on Example

❖ Network Management Tool

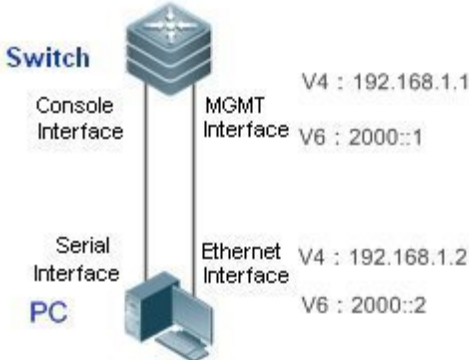
<p>Scenario Figure 14-7</p>	
<p>Configuration Steps</p>	<ul style="list-style-type: none"> ➤ Connect the serial interface of PC to the Console interface of the switch. ➤ Configure the Layer-3 IPv4 address of the MGMT interface on the switch to 192.168.1.1. ➤ Configure the Layer-3 IPv6 address of the MGMT interface on the switch to 2000::1. ➤ Configure the IPv6 gateway address of the management network to 2000::2. ➤ Connect the Ethernet interface of PC to the MGMT interface of the switch. ➤ Configure the IPv4 and IPv6 addresses of the Ethernet interface of PC to 192.168.1.2 and 2000::2 respectively. ➤ Detect reachability of the IPv4 and IPv6 addresses of PC via the MGMT interface. ➤ Trace the IPv4 and IPv6 routes via the MGMT interface.
<p>Switch</p>	<pre>Qtech# configure Qtech(config)# int mgmt 0 Qtech(config if Mgmt 0)# ip address 192.168.1.1 255.255.255.0 Qtech(config if Mgmt 0)# ipv6 address 2000::1/64 Qtech# ping oob 192.168.1.2 Qtech# traceroute oob 192.168.1.2 Qtech# ping oob ipv6 2000::2 Qtech# traceroute oob ipv6 2000::2</pre>
<p>Verification</p>	<ul style="list-style-type: none"> ➤ View the real-time process. Hosts on the management network can be pinged and the traceroute command can be used to trace routes to hosts on the management network.
<p>Switch</p>	<pre>Qtech# ping oob 192.168.1.2 Sending 5, 100 byte ICMP Echoes to 192.168.1.2, timeout is 2 seconds: !!!! Success rate is 100 percent, round trip min/avg/max = 4/4/4 ms</pre>

```

Qttech# traceroute oob 192.168.1.2

Tracing route to 192.168.1.2 over a maximum of 10 hops
 1  <10 ms  <10 ms  <10 ms  192.168.1.2

Qttech# ping oob ipv6 2000::2

Sending 5, 100 byte ICMP Echoes to 2000::2, timeout is 2 seconds:
  < press Ctrl+C to break >

!!!!!!

Success rate is 100 percent (5/5), round trip min/avg/max = 1/1/1 ms.

Qttech# traceroute oob ipv6 2000::2

Tracing route to 2000::2 over a maximum of 10 hops
 1  <10 ms  <10 ms  <10 ms  2000::2

```

14.4.3 File Management

Configurati on Effect

- Copy a file from a position specified by the source URL to a position specified by the destination URL via the MGMT interface.

Configurati on Steps

- ❖ File management
- Enter the privileged mode.
- Copy a file from a position specified by the source URL to a position specified by the destination URL.

Verification

- View the real-time process.

Related Commands

- ❖ File management

Command	<code>copy oob_ftp://source-url destination-url</code>
Parameter	<i>source-url</i> : Indicates the source URL of the file.
Description	<i>destination-url</i> : Indicates the destination URL of the file.
Command Mode	Privileged mode

Usage Guide	-
-------------	---

Configuration on Example

❖ File management

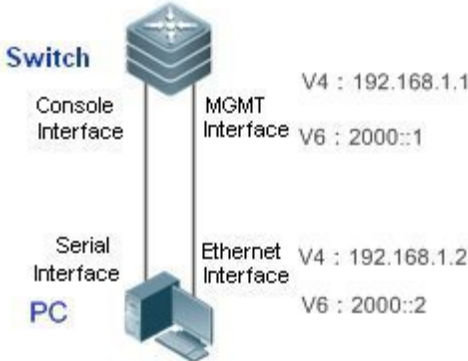
<p>Scenario Figure 14-8</p>	
<p>Configuration Steps</p>	<ul style="list-style-type: none"> ➤ Connect the serial interface of PC to the Console interface of the switch. ➤ Configure the Layer-3 IPv4 address of the MGMT interface on the switch to 192.168.1.1. ➤ Configure the Layer-3 IPv6 address of the MGMT interface on the switch to 2000::1. ➤ Connect the Ethernet interface of PC to the MGMT interface of the switch. ➤ Configure the IPv4 and IPv6 addresses of the Ethernet interface of PC to 192.168.1.2 and 2000::2 respectively. ➤ Enable the TFTP server for PC based on IPv4. ➤ Enable the TFTP server for PC based on IPv6. ➤ Download a file from an IPv4 host on the management network to a flash file system. ➤ Download a file from an IPv6 host on the management network to a flash file system.
<p>Switch</p>	<pre>Qtech# configure Qtech(config)# int mgmt 0 Qtech(config-if Mgmt 0)# ip address 192.168.1.1 255.255.255.0 Qtech(config-if Mgmt 0)# ipv6 address 2000::1/64 Qtech# copy oob_tftp://192.168.1.2/ngsa compress.bin Qtech# copy oob_tftp://[2000::2]/ngsa compress.bin</pre>
<p>Verification</p>	<ul style="list-style-type: none"> ➤ View the real-time process. A file is downloaded from an IPv4/IPv6 host on the management network to a flash file system.
<p>Switch</p>	<pre>Qtech# copy oob_tftp://192.168.1.2/ngsa compress.bin</pre>

```
flash:file.bin
Accessing tftp://192.168.1.2/ngsa compress.bin...
!!!!!!!!!!!!!!!!!!!!!!!!!!!!!!!!!!!!!!!!!!!!!!!!!!!!!!!!!!!!!!!!!!!!!!!!!!!!
!!!!!!!!!!!!!!
Success : Transmission success, file length 1183856 bytes
Qtech# copy oob_tftp://[2000::2]/ngsa compress.bin
flash:file.bin
Accessing tftp://192.168.1.2/ngsa compress.bin...
!!!!!!!!!!!!!!!!!!!!!!!!!!!!!!!!!!!!!!!!!!!!!!!!!!!!!!!!!!!!!!!!!!!!!!!!!!!!
!!!!!!!!!!!!!!
Success : Transmission success, file length 1183856 bytes
```

14.4.4 Network Login Management

Configurati on Effect

- Log in to other devices or hosts via the MGMT interface.

Configurati on Steps

- ❖ Network login management
 - Enter the privileged mode.
 - Log in to other devices or hosts via the MGMT interface.

Verification

- View the real-time process.

Related Commands

- ❖ Network login management

Command	<code>telnet oob ip-address ipv6-address</code>
Parameter Description	<i>ip-address</i> : Indicates an IPv4 address. <i>i</i> : Indicates an IPv6 address.
Command Mode	Privileged mode
Usage Guide	This command is used to execute a telnet command on the device and perform data interaction via the MGMT interface. During configuration, it does not need to specify such parameters as ip and ipv6 to specify which protocol (IPv4/IPv6) is to be used, because the system automatically determines the input

address is a valid IPv4 or IPv6 address.

Configurati on Example

❖ Network login management

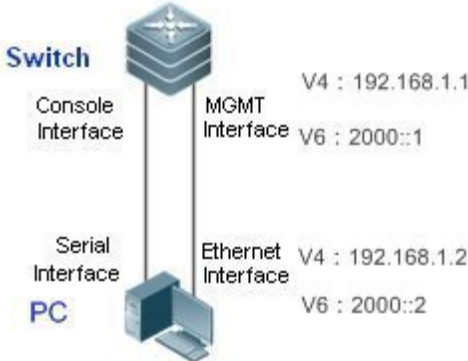
<p>Scenario Figure 14-9</p>	
<p>Configuratio n Steps</p>	<ul style="list-style-type: none"> ➤ Connect the serial interface of PC to the Console interface of the switch. ➤ Configure the Layer-3 IPv4 address of the MGMT interface on the switch to 192.168.1.1. ➤ Configure the Layer-3 IPv6 address of the MGMT interface on the switch to 2000::1. ➤ Connect the Ethernet interface of PC to the MGMT interface of the switch. ➤ Configure the IPv4 and IPv6 addresses of the Ethernet interface of PC to 192.168.1.2 and 2000::2 respectively. ➤ Enable the telnet server for PC based on IPv4. ➤ Enable the telnet server for PC based on IPv6. ➤ Switch A logs in to PC via the MGMT interface.
<p>Switch</p>	<pre>Qtech A# configure Qtech A(config)# int mgmt 0 Qtech A(config if Mgmt 0)# ip address 192.168.1.1 255.255.255.0 Qtech A(config if Mgmt 0)# ipv6 address 2000::1/64 Qtech A# telnet oob 192.168.1.2 Qtech A# telnet oob 2000::2</pre>
<p>Verification</p>	<ul style="list-style-type: none"> ➤ View the real-time process. The switch can log in to PC.
<p>Switch A</p>	<pre>Qtech A# telnet oob 192.168.1.2 User Access Verification Password: Qtech A# telnet oob 2000::2</pre>

	User Access Verification
	Password:

14.4.5 MIB Management

Configuration Effect

- Specify to send a trap message to the NMS server via the MGMT interface and the IPv4 address of the NMS server.
- Specify to send a trap message to the NMS server via the MGMT interface and the IPv6 address of the NMS server.

Configuration Steps

- ❖ MIB management
 - Enter the global mode.
 - Specify to send a trap message via the MGMT interface and the IPv4 address of the NMS server.
 - Specify to send a trap message via the MGMT interface and the IPv6 address of the NMS server.

Verification

- Run the **show running** command to check the configurations.

Related Commands

- ❖ Specifying to send a trap message via the MGMT interface and the IPv4 address of the NMS server

Command	snmp-server host oob <i>ip-address</i>
Parameter Description	<i>ip-address</i> : Indicates an IPv4 address.
Command Mode	Global configuration mode
Usage Guide	-

- ❖ Specifying to send a trap message via the MGMT interface and the IPv6 address of the NMS server

Command	snmp-server host oob ipv6 <i>ipv6-address</i>
Parameter	<i>ipv6-address</i> : Indicates an IPv6 address.

Description	
Command Mode	Global configuration mode
Usage Guide	-

Configuration Example

❖ Configuring MIB management of the MGMT interface

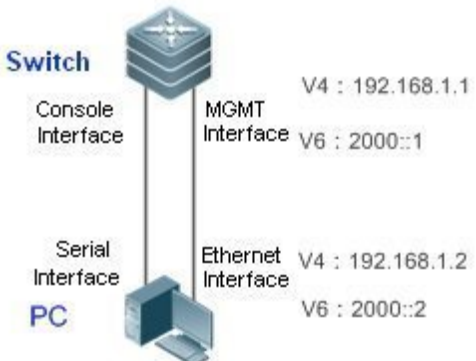
<p>Scenario Figure 14-10</p>	
<p>Configuration Steps</p>	<ul style="list-style-type: none"> ➤ Connect the serial interface of PC to the Console interface of the switch. ➤ Configure the Layer-3 IPv4 address of the MGMT interface on the switch to 192.168.1.1. ➤ Configure the Layer-3 IPv6 address of the MGMT interface on the switch to 2000::1. ➤ Connect the Ethernet interface of PC to the MGMT interface of the switch. ➤ Configure the IPv4 and IPv6 addresses of the Ethernet interface of PC to 192.168.1.2 and 2000::2 respectively. ➤ Enable the NMS server for PC based on IPv4. ➤ Enable the NMS server for PC based on IPv6. ➤ Specify to send a trap message via the MGMT interface and the IPv4 address of the NMS server ➤ Specify to send a trap message via the MGMT interface and the IPv4 address of the NMS server
<p>Switch</p>	<pre>Qtech# configure Qtech(config)# int mgmt 0 Qtech(config if Mgmt 0)# ip address 192.168.1.1 255.255.255.0 Qtech(config if Mgmt 0)# ipv6 address 2000::1/64 Qtech(config)# snmp server host oob 192.168.1.2 Qtech(config)# snmp server host oob ipv6 2000::2</pre>

Verification	➤ Run the show running command to check the above configurations on the switch.
Switch	<pre>Qtech# show running include snmp server snmp server host oob 192.168.1.2 snmp server host oob ipv6 2000::2</pre>

14.4.6 Log Management

Configurati on Effect

- Specify to send a log message via the MGMT interface and the IPv4 address of the Syslog server
- Specify to send a log message via the MGMT interface and the IPv6 address of the Syslog server

Notes

- -

Configurati on Steps

- ❖ Log management
 - Enter the global mode.
 - Specify to send a log message via the MGMT interface and the IPv4 address of the Syslog server
 - Specify to send a log message via the MGMT interface and the IPv6 address of the Syslog server

Verification

- Run the **show running** command to check the configurations.

Related Commands

- ❖ Specifying to send a log message via the MGMT interface and the IPv4 address of the Syslog server

Command	logging server oob <i>ip-address</i>
Parameter	<i>ip-address</i> : Indicates an IPv4 address.
Description	
Command	Global configuration mode

Mode	
Usage Guide	-

- ❖ Specifying to send a log message via the MGMT interface and the IPv6 address of the Syslog server

Command	logging server oob ipv6 <i>ipv6-address</i>
Parameter Description	<i>ipv6-address</i> : Indicates an IPv6 address.
Command Mode	Global configuration mode
Usage Guide	-

Configuration Example

- ❖ Configuring MIB management of the MGMT interface

<p>Scenario Figure 14-11</p>	
<p>Configuration Steps</p>	<ul style="list-style-type: none"> ➤ Connect the serial interface of PC to the Console interface of the switch. ➤ Configure the Layer-3 IPv4 address of the MGMT interface on the switch to 192.168.1.1. ➤ Configure the Layer-3 IPv6 address of the MGMT interface on the switch to 2000::1. ➤ Connect the Ethernet interface of PC to the MGMT interface of the switch. ➤ Configure the IPv4 and IPv6 addresses of the Ethernet interface of PC to 192.168.1.2 and 2000::2 respectively. ➤ Enable the Syslog server for PC based on IPv4. ➤ Enable the Syslog server for PC based on IPv6. ➤ Specify to send a log message via the MGMT interface and the IPv4 address of the Syslog server ➤ Specify to send a log message via the MGMT interface and the IPv6 address of the Syslog server
<p>Switch</p>	<pre>Qtech# configure</pre>

	<pre>Qtech(config)# int mgmt 0 Qtech(config if Mgmt 0)# ip address 192.168.1.1 255.255.255.0 Qtech(config if Mgmt 0)# ipv6 address 2000::1/64 Qtech(config)# logging server oob 192.168.1.2 Qtech(config)# logging server oob ipv6 2000::2</pre>
Verification	➤ Run the show running command to check the above configurations.
Switch	<pre>Qtech# show running include logging logging server oob 192.168.1.2 logging server oob ipv6 2000::2</pre>

14.5 Monitoring

Displaying

Description	Command
Displays the member state and statistical information of the virtual MGMT interface.	show mgmt virtual

15. CONFIGURING HASH SIMULATOR

15.1 Overview

HASH simulator is a program that simulates the HASH algorithm of the switch. HASH simulator supports Aggregate Port (AP) load-balancing and Equal-Cost Multipath Routing (ECMP) load-balancing modes.

- AP HASH simulator simulates the HASH algorithm to calculate the AP member port for packet forwarding based on the packet field, load-balancing mode and specified AP information. The calculation result conforms to the real forwarding port.



Note If you configure AP on a switch, use the AP simulator to calculate the AP member port for packet forwarding by specifying the packet field.

- ECMP HASH simulator simulates the HASH algorithm to calculate the next hop for packet forwarding based on the packet field and load balance mode. The calculation result conforms to the real forwarding next hop.



Note If you configure ECMP on a switch and want to know the next hop for specified packets without doing tests, use the ECMP simulator to calculate the hit next hop.

HASH simulator can be used to track and monitor the forwarding path of specified packets, facilitating user management and troubleshooting.

Protocols and Standards

- IEEE 802.3ad

15.2 Applications

Application	Description
AP HASH Simulator	Combining multiple physical links into one logical link is an effective way to increase port bandwidth and improve reliability on a L3 switch. Packets are forwarded through a physical link according to load balance algorithm. AP simulator calculation enables users to check the member link, which serves as reference for troubleshooting and topology deployment.
ECMP HASH Simulator	On a L3 switch configured with ECMP, packets are forward through an ECMP load-balanced next hop. ECMP simulator calculation enables users to check the member link, which serves as reference for troubleshooting and topology

deployment.

15.2.1 AP HASH Simulator

Scenario

With HASH simulator, you can calculate the AP load-balanced forwarding port.

- AP load balancing: The dual-NIC server is aggregated into one logical link to share service data flow.
- You should know which NIC on the server receives the packets with destination IP addresses of 2.2.2.1/24, 4.4.4.1/24, and 9.9.9.1/24 sent by the uplinked server.

Figure 15-1

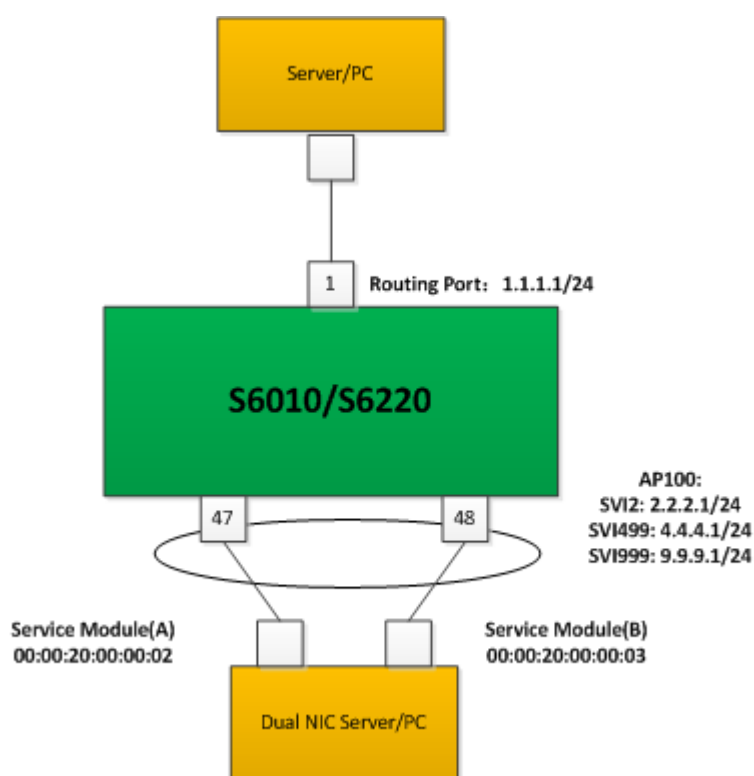

Note N/A

Deployment

- The ports connecting the dual NIC server and S6010/S6220 are aggregated into an AP to share service data flow.
- Use VLAN 2, VLAN 499 and VLAN 999 to separate the network and undertake different types of service.

- You can identify the AP load-balanced forwarding port on S6010/S6220 according to packet features.



Note The packet feature can be Source IP, Destination IP, Source L4 port, or Destination L4 port.

15.2.2 ECMP HASH Simulator

Scenario

With HASH simulator, you can calculate the ECMP load-balanced next hop.

- SW1 is uplinked to network segment 1.0.0.0/24 and downlinked to network segment 2.2.2.0/24. The uplink PC can communicate with the downlink clients via SW1.
- You should know which downlink port can receive or forward packets containing different IP addresses sent by the uplink PC.

Figure 15-2

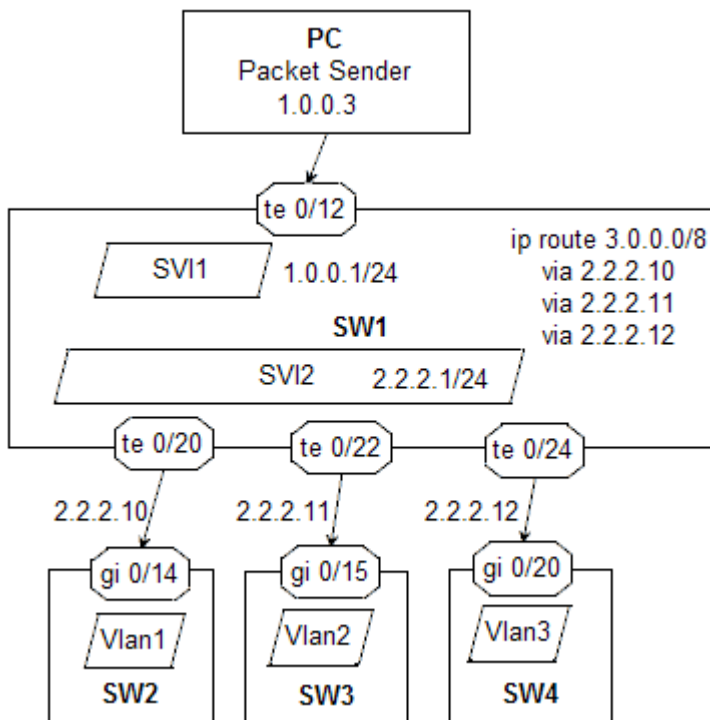

Note N/A

Deployment

- Configure an ECMP route to 3.0.0.0/8 on SW1 and multiple ECMP next hops connect with the downlink.

- You can identify the ECMP load-balanced next hop on SW1 according to packet features.



Note

The packet feature can be Source IP, Destination IP, Source L4 port, or Destination L4 port.

15.3 Features

Basic Concepts

AP

AP is a logical port that consists of several physical ports. AP can be divided into static AP and dynamic AP (LACP AP) based on protocol or into L2 AP and L3 AP based on port feature.

L2 AP

L2 AP is a logical port that consists of several L2 ports with the same L2 features.

L3 AP

L3 AP is a logical port that consists of several L3 ports with the same L3 features.

Load-balancing Mode

Packets are forwarded by an AP member port based on its load-balancing mode. The following AP load-balancing modes are available:

- Source MAC address/ destination MAC address (Src-mac/Dst-mac)
- Source MAC address + destination MAC address (Src-dst-mac)
- Source IP address/ destination IP address (Src-ip/Dst-ip)
- Source IP address + destination IP address (Src-dst-ip)
- Source IP address + destination IP address + source L4 port + destination L4 port (Src-dst-ip-l4port)
- Panel port of incoming packets
- Enhanced Mode (Enhanced)

ECMP

ECMP is a routing strategy where next-hop packet forwarding to a single destination can occur over multiple "best paths" which tie for top place in routing metric calculations. When a next hop becomes unreachable, traffic is switched to the other next hops.



Note

The ECMP next hop is also selected based on the load-balancing mode.

HASH Simulator

HASH simulator is a program that simulates the HASH algorithm of the switch.

Quintuple

The quintuple refers to the source IP address, destination IP address, protocol, source L4 port and destination L4 port.

Overview

Overview	Description
AP HASH Simulator	Calculates the AP member port for packet forwarding according to the packet field, AP load balance mode and specified AP information.
ECMP HASH Simulator	Calculates the next hop for packet forwarding according to the packet field, load balance mode and destination IP address.

15.3.1 AP HASH Simulator

AP HASH simulator is used to calculate the AP member port for packet forwarding by specifying the packet field.

Working Principle

HASH simulator simulates the HASH algorithm on the switch. The process of AP load-balancing calculation on a switch follows the following steps:

Figure 15-3

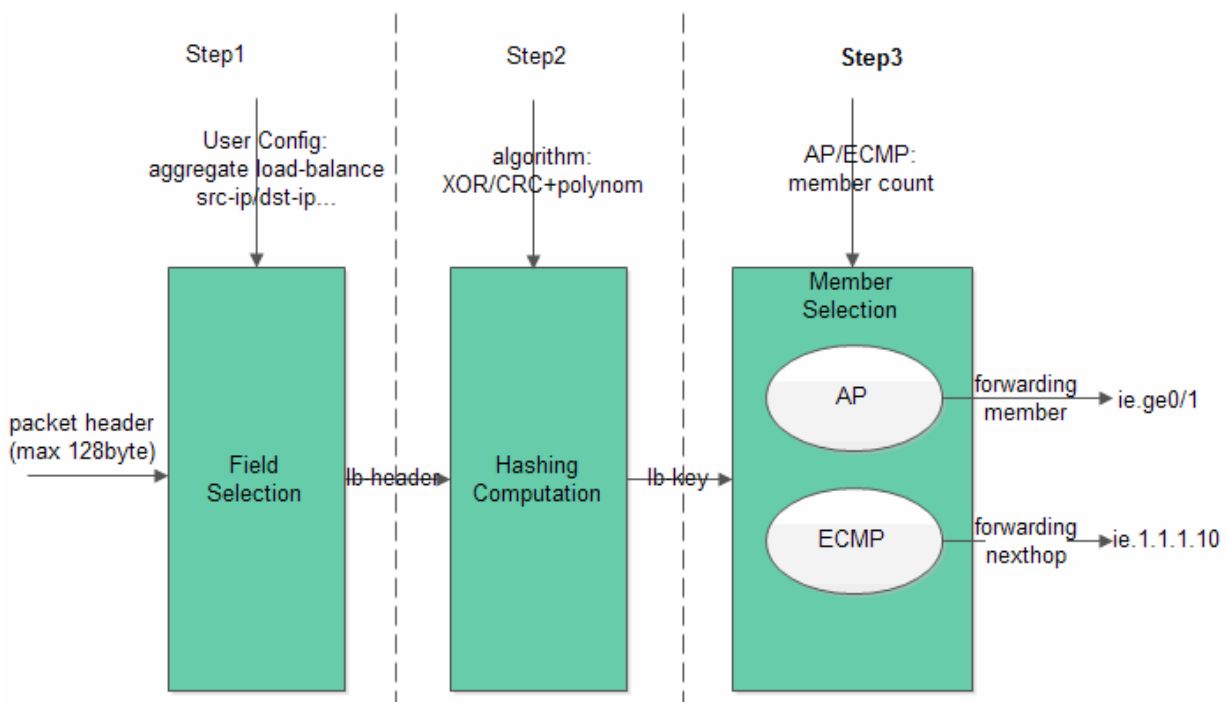

- Step1: Field Selection. Fields are extracted according to the configured load-balancing mode.

Different fields are selected as HASH factors based on the configured load-balancing mode:

Load-balancing Mode	HASH Factor
Src-mac	mac address source
Dst-mac	mac address destination
Src-dst-mac	mac address source and destination
Src-ip	IP address source
Dst-ip	IP address destination
Src-dst-ip	IP address source and destination
Src-dst-ip-l4port	IP address source and destination, L4 port source and destination
Enhanced	Fields are extracted according to load-balance profile. Use the show load-balance profile <i>profile-name</i> command to display all packet fields corresponding to supported packet types.

- ✔ AP HASH simulator supports src-ip, dst-ip, src-dst-ip, src-dst-ip-l4port and enhanced load-balancing modes.



Note Selected HASH factors for AP load-balancing may vary with different products.

- Step2: HASH Computation

HASH algorithm is used to compute the HASH lb-key (load-balance key) based on the HASH factor selected in step 1. HASH algorithms vary with different switches, such as XOR, CRC and CRC+ scramble.

HASH simulator simulates the HASH algorithm on the switch.

- Step3: Member Selection

Divide the AP member number by HASH lb-key, and the remainder is the forwarding port index. The index is unique on Qtech BCM series switch (including core switch and access switch). Therefore, it can be used to identify the forwarding port.

Related Configuration

Displaying AP simulator calculation result

Users can check the IPv4 AP load-balanced forwarding port by specifying the quintuple feature of IPv4 packets.

Users can check the IPv6 AP load-balanced forwarding port by specifying the quintuple feature of IPv6 packets.

- ✓ AP HASH simulator supports simulative calculation of unicast packet forwarding only.

15.3.2 ECMP HASH Simulator

ECMP HASH simulator is used to calculate the next hop for packet forwarding by specifying the packet field.

Working Principle

ECMP HASH simulator simulates the HASH algorithm, similar to AP HASH simulator.

- Step1: Field Selection. Fields are extracted according to the configured load balance mode.
ECMP load-balancing modes share configuration with AP load-balancing modes. Load-balancing modes correspond to HASH factors as follows:

Load-balancing Mode	HASH Factor
Src-mac	IP address source
Dst-mac	IP address source
Src-dst-mac	IP address source
Src-ip	IP address source
Dst-ip	IP address source and destination
Src-dst-ip	IP address source and destination
Src-dst-ip-l4port	IP address source and destination, L4 port source and destination
Enhanced	Fields are extracted according to load-balance profile. Use the show load-balance profile profile-name command to display all packet fields corresponding to supported packet types.

- ✓ ECMP HASH simulator supports src-ip, dst-ip, src-dst-ip, src-dst-ip-l4port and enhanced load-balancing modes.



Note

Selected HASH factors for ECMP load balancing vary with different products.



Caution

For some products like N18000-CB, load-balancing modes correspond to HASH factors. For example, the src-mac mode corresponds to the HASH factor of source MAC address; the dst-mac mode corresponds to the HASH factor of destination MAC address.

- Step2: HASH Computation

HASH algorithm is used to compute the HASH lb-key (load-balance key) based on the HASH factor selected in step 1. ECMP load balance supports HASH algorithms of CRC and CRC+scramble.

- Step3: Member Selection

Divide the ECMP next hop number by HASH lb-key, and the remainder is the next-hop index. The unique index can be used to identify the next hop.

Related Configuration

Displaying ECMP simulator calculation result

Users can check the IPv4 ECMP load-balanced next hop by specifying the quintuple feature of IPv4 packets.

Users can check the IPv6 ECMP load-balanced next hop by specifying the quintuple feature of IPv6 packets.



Note If the ECMP next hop is an AP, the forwarding port is selected based on AP load balance mode. Users can enter the command to display the packet forwarding port.

15.4 Configuration

Configuration	Description and Command
	 Note Optional
Displaying AP load-balanced forwarding port	show aggregate load-balance to interface aggregateport ap-id ip [source source-ip] [destination dest-ip] [ip-protocol protocol-id] [I4-source-port src-port] [I4-dest-port dest-port] Displaying IPv4 AP load-balanced forwarding port
	show aggregate load-balance to interface aggregateport ap-id ipv6 [source source-ip] [destination dest-ip] [ip-protocol protocol-id] [I4-source-port src-port] [I4-dest-port dest-port] Displaying IPv6 AP load-balanced forwarding port

Displaying ECMP load-balanced forwarding port	<pre>show ip ecmp-nexthop address destination dest-ip [source source-ip] [protocol protocol-id] [I4-source-port src-port] [I4-dest-port dst-port]] [vrf vrf-name]</pre>	Displaying IPv4 ECMP next hop
	<pre>show ipv6 ecmp-nexthop address destination dest-ip [source source-ip] [next-header protocol-id] [I4-source-port src-port] [I4-dest-port dst-port]] [vrf vrf-name]</pre>	Displaying IPv6 ECMP next hop

15.4.1 Displaying AP Load-Balanced Forwarding Port

Configuration Effect

- Display the AP member port for packet forwarding.

Notes

- AP hash simulator works based on the AP load-balancing mode. Therefore, use the aggregate load-balance command to configure the AP load-balancing mode first.
- Create AP and add member ports.



Note

See *Configuring Aggregate Port* in *Ethernet Switching Configuration Guide*.

Configuration Steps

Displaying IPv4 AP load-balanced forwarding port

- Monitor forwarding path and troubleshooting.
- Enter the command to display AP forwarding ports on the switch.

Displaying IPv6 AP load-balanced forwarding port

- **The same as above.**

Verification

- Verify the configuration by pumping real traffic. Observe and record the forwarding port.
- Check whether the real forwarding port conforms to the displayed port.

Related Commands

Displaying IPv4 AP load-balanced forwarding port

Command	show aggregate load-balance to interface aggregateport <i>ap-id</i> ip [source <i>source-ip</i>] [destination <i>dest-ip</i>] [ip-protocol <i>protocol-id</i>] [I4-source-port <i>src-port</i>] [I4-dest-port <i>dest-port</i>]
Parameter	aggregateport <i>ap-id</i> : Destination AP ID. source <i>source-ip</i> : Source IPv4 address destination <i>dest-ip</i> : Destination IPv4 address ip-protocol <i>protocol-id</i> : IP protocol ID. For example, the protocol ID of TCP and UDP are 6 and 17 respectively. I4-source-port <i>src-port</i> : L4 source port ID I4-dest-port <i>dst-port</i> : L4 destination port ID
Command Mode	Privileged EXEC mode/Global configuration mode/Interface configuration mode
Usage Guide	N/A

Displaying IPv6 AP load-balanced forwarding port

Command	show aggregate load-balance to interface aggregateport <i>ap-id</i> ipv6 [source <i>source-ip</i>] [destination <i>dest-ip</i>] [ip-protocol <i>protocol-id</i>] [I4-source-port <i>src-port</i>] [I4-dest-port <i>dest-port</i>]
Parameter	aggregateport <i>ap-id</i> : Destination AP ID source <i>source-ip</i> : Source IPv6 address destination <i>dest-ip</i> : Destination IPv6 address ip-protocol <i>protocol-id</i> : IP protocol ID. For example, the protocol ID of TCP and UDP are 6 and 17 respectively. I4-source-port <i>src-port</i> : L4 source port ID I4-dest-port <i>dst-port</i> : L4 destination port ID
Command Mode	Privileged EXEC mode/Global configuration mode/interface configuration mode
Usage Guide	N/A

Common Errors

- AP HASH simulator does not support the configured load-balancing mode.
- The current switch does not support AP HASH simulator.
- AP is not created or does not have member ports.

Configuration Example

Displaying IPv4 AP load-balanced forwarding port

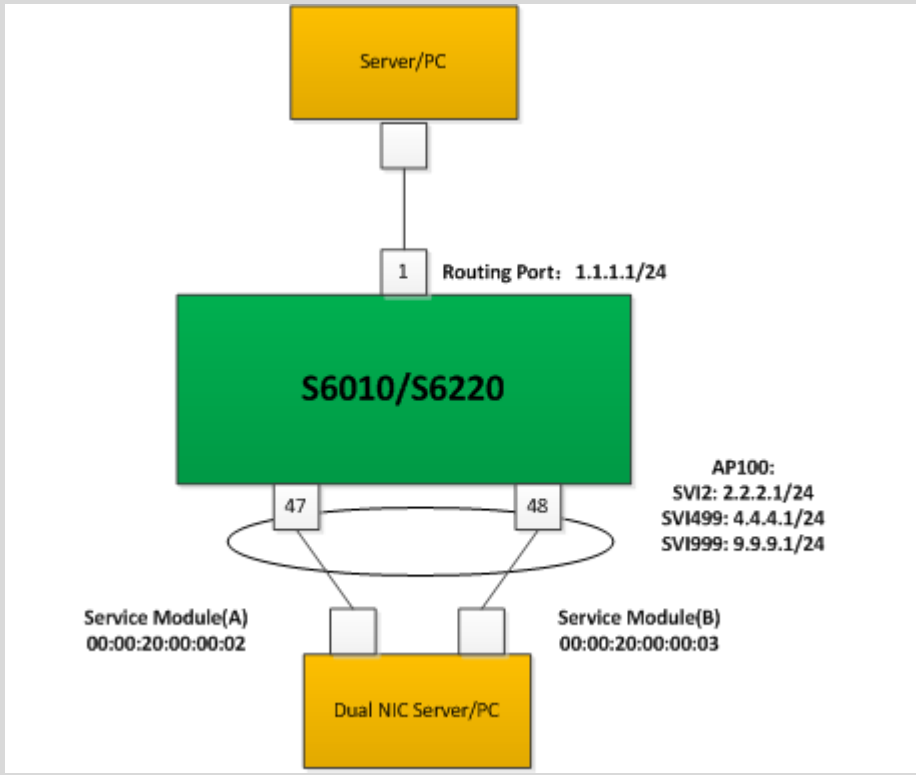
<p>Network Environment</p> <p>Figure 15-4</p>	
<p>Configuration Steps</p>	<p>Configure the load-balancing mode.</p> <pre>Qtech# configure terminal Qtech(config)# aggregate load balance dst ip Qtech(config)# show agg load balance Load balance : Destination IP Qtech# end</pre>
<p>Verification</p>	<p>Use the show aggregate load-balance to command to display AP forwarding port.</p> <ul style="list-style-type: none"> ● Display AP load-balanced forwarding port for packets destined to IP address 2.2.2.2. <pre>Qtech# show aggregate load balance to interface aggregateport 1 ip destination 2.2.2.2 aggregateport load balance mode : Destination IP balance to port : GigabitEthernet 0/47</pre> <ul style="list-style-type: none"> ● Display AP load-balanced forwarding port for packets destined to IP address 4.4.4.4. <pre>Qtech# show aggregate load balance to interface</pre>

```
aggregateport 1 ip destination 4.4.4.4  
aggregateport load balance mode : Destination IP  
balance to port : GigabitEthernet 0/48
```

- If the specified AP does not have member ports, the forwarding port is displayed as NULL.

```
Qtech# show aggregate load balance to interface  
aggregateport 1 ip source 1.1.1.1  
aggregateport load balance mode : Destination IP  
balance to port :
```

15.4.2 Displaying ECMP Load-Balanced Forwarding Port

Configuration Effect

- Display the ECMP next hop for packet forwarding.

Notes

- Only reachable next hops are load-balanced.

Configuration Steps

Displaying IPv4 ECMP next hop

- Monitor forwarding path and troubleshooting.
- Enter the command to display AP forwarding ports on the switch.

Displaying IPv6 ECMP next hop

The same as above

Verification

- Verify the configuration by pumping real flows. Observe and record the forwarding next hop.
- Check whether the real next hop conforms to the displayed next hop.

Related Commands

Displaying IPv4 ECMP next hop

Command	<code>show ip ecmp-nexthop address destination <i>dest-ip</i> [source <i>source-ip</i>] [<i>protocol protocol-id</i>] [<i>I4-source-port src-port</i>] [<i>I4-dest-port dst-port</i>] [<i>vrf vrf-name</i>]</code>
Parameter	source <i>source-ip</i> : Source IPv4 address destination <i>dest-ip</i> : Destination IPv4 address

	<p>protocol <i>protocol-id</i>: IP protocol ID. For example, the protocol ID of TCP, UDP and ICMP are 6,17 and 1 respectively.</p> <p>I4-source-port <i>src-port</i>: L4 source port ID</p> <p>I4-dest-port <i>dst-port</i>: L4 destination port ID</p> <p>vrf <i>vrf-name</i>: VRF name</p>
Command Mode	Privileged EXEC mode/Global configuration mode/Interface configuration mode
Usage Guide	N/A

Displaying IPv6 ECMP next hop

Command `show ipv6 ecmp-nexthop address destination dest-ip [source source-ip] [next-header protocol-id] [I4-source-port src-port] [I4-dest-port dst-port] [vrf vrf-name]`

Parameter

source *source-ip*: Source IPv6 address

destination *dest-ip*: Destination IPv6 address

next-header *protocol-id*: IP protocol ID. For example, the protocol ID of TCP, UDP and ICMP are 6,17 and 1 respectively.

I4-source-port *src-port*: L4 source port ID

I4-dest-port *dst-port*: L4 destination port ID

vrf *vrf-name*: VRF name

Command Mode Privileged EXEC mode/Global configuration mode/Interface configuration mode

Usage Guide N/A

Common Errors

- ECMP HASH simulator does not support the configured load-balancing mode.
- The current switch does not support ECMP HASH simulator.
- ECMP is not configured or no reachable next hop is available.

Configuration Example

Displaying IPv4 ECMP next hop

<p>Network Environment Figure 15-5</p>	
---	--

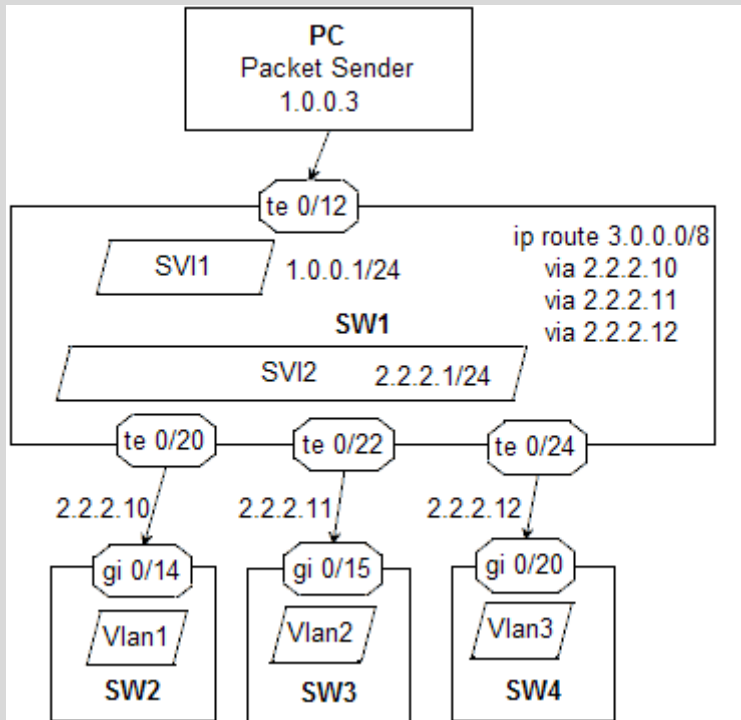

<p>Configuration Steps</p>	<ol style="list-style-type: none"> 1. Configure ECMP. 2. Configure the load-balancing mode.
	<pre>Qtech# configure terminal Qtech(config)# aggregate load balance src dst ip Qtech(config)# show agg load balance Load balance : Source IP and Destination IP Qtech(config)# end</pre>
<p>Verification</p>	<p>Use the show ip ecmp-nexthop command to display the route in vrf 0. The hit next hop is marked by "*". The DIP parameter is mandatory whether it is necessary for the HASH calculation. ECMP HASH simulator can be used to calculate one single next hop for a uni-route.</p> <p>Display the ECMP load-balanced next hop for packets from 1.0.0.1 to 3.0.0.1. Change the destination IP address to 3.0.0.2 and display the next hop again.</p> <pre>Qtech#show ip ecmp nexthop address destination 3.0.0.1 source 1.0.0.1 balance mode: Source IP and Destination IP route table: vrf 0</pre>

```
hit ip route, actual nexthop marked by "*":
3.0.0.0/8
  via 2.2.2.10 weight 1
  via 2.2.2.11 weight 1 *
  via 2.2.2.12 weight 1
Qtech#show ip ecmp nexthop address destination 3.0.0.2 source 1.0.0.1
balance mode:  Source IP and Destination IP
route table:  vrf 0
hit ip route, actual nexthop marked by "*":
3.0.0.0/8
  via 2.2.2.10 weight 1
  via 2.2.2.11 weight 1
  via 2.2.2.12 weight 1 *
```

If the DIP in the entered CLI command does not hit the routing table, an error is displayed.

```
Qtech#show ip ecmp nexthop address destination 5.0.0.1 source 1.0.0.7
%ecmp HASH failed, for look up time out or no route hitted
```

Display the ECMP load-balanced next hop for packets from 1.0.0.1 to 3.0.0.1.
Change the source IP address to 1.0.0.3 and display the next hop again.

```
Qtech#show ip ecmp nexthop address destination 3.0.0.1 source 1.0.0.1
balance mode:  Source IP and Destination IP
route table:  vrf 0
hit ip route, actual nexthop marked by "*":
3.0.0.0/8
  via 2.2.2.10 weight 1
  via 2.2.2.11 weight 1 *
  via 2.2.2.12 weight 1
Qtech#show ip ecmp nexthop address destination 3.0.0.1 source 1.0.0.3
balance mode:  Source IP and Destination IP
route table:  vrf 0
hit ip route, actual nexthop marked by "*":
3.0.0.0/8
```

```
via 2.2.2.10 weight 1 *  
via 2.2.2.11 weight 1  
via 2.2.2.12 weight 1
```

The ECMP next hop is down. Display the simulatively calculated next hop again.

```
Qttech#show arp  
Protocol Address Age (min) Hardware Type Interface  
Internet 2.2.2.11 <static> 0000.0000.0011 arpa VLAN 2  
Internet 2.2.2.12 <static> 0000.0000.0012 arpa VLAN 2  
Internet 1.0.0.1 08c6.b322.33b2 arpa VLAN 1  
Internet 2.2.2.1 08c6.b322.33b2 arpa VLAN 2  
Internet 2.2.2.10 < > <Incomplete> arpa VLAN 2
```

Display the ECMP load-balanced next hop for the packets from 1.0.0.1 to 3.0.0.1, to 3.0.0.2 and to 3.0.0.6 respectively again.

```
Qttech#show ip ec ad de 3.0.0.1 so 1.0.0.1  
balance mode: Source IP and Destination IP  
route table: vrf 0  
hit ip route, actual nexthop marked by "*":  
3.0.0.0/8  
via 2.2.2.10 weight 1  
via 2.2.2.11 weight 1 *  
via 2.2.2.12 weight 1  
Qttech#show ip ec ad de 3.0.0.2 so 1.0.0.1  
balance mode: Source IP and Destination IP  
route table: vrf 0  
hit ip route, actual nexthop marked by "*":  
3.0.0.0/8  
via 2.2.2.10 weight 1  
via 2.2.2.11 weight 1  
via 2.2.2.12 weight 1 *  
Qttech#show ip ec ad de 3.0.0.6 so 1.0.0.1  
balance mode: Source IP and Destination IP
```

```
route table:   vrf 0
hit ip route, actual nexthop marked by "*":
3.0.0.0/8
  via 2.2.2.10 weight 1
  via 2.2.2.11 weight 1 *
  via 2.2.2.12 weight 1
```