

MPLS Configuration

Оглавление

1.	Configuring MPLS	6
1.1	Overview	6
1.1.1	Basic Concepts	7
1.1.2	Label	9
1.1.3	MPLS Network	11
1.1.4	MPLS Forwarding Actions	12
1.1.5	LSP Setup and Loop Detection	13
1.1.6	LDP Inter-Area LSP	14
1.1.7	LDP Session Protection	16
1.1.8	Applications	17
1.2	Configuration	17
1.2.1	Enabling MPLS Globally	18
1.2.2	Enabling LDP Globally	18
1.2.3	Enabling Label Switching on an Interface	19
1.2.4	Enabling LDP on an Interface	19
1.2.5	Configuring MPLS MTU on an Interface (Optional)	20
1.2.6	Fragmenting MPLS Packets (Optional)	20
1.2.7	Handling ICMP Error Messages (Optional)	21
1.2.8	Configuring the MPLS TTL Replication Function (Optional)	21
1.2.9	Verifying the MPLS Information	22
1.2.10	Configuring Optional LDP Parameters (Optional)	23
1.2.11	Configuring Static MPLS Forwarding	34
1.3	Configuration Example	41
1.3.1	Basic MPLS Function Examples	41
1.3.2	Setting Up an LSP Through LDP	42
1.3.3	Configuring a Static LSP	43
1.3.4	LDP Inter-Area LSP Configuration Example	45
1.3.5	LDP Session Protection Configuration Example	58
2.	Configuring L2VPN	62
2.1	Overview	62
2.1.1	Basic Concepts	63

2.1.2	Basic Forwarding Process	66
2.2	Configuring VPWS	67
	Introduction to VPWS	67
2.2.1	Configuring Martini VPWS	68
	Configuring Kompella VPWS.....	85
	Configuring in and out Labels for the Static PW	105
	Verification.....	105
	MartiniVPWS Switch Configuration Instance	106
	MartiniVPWS Router Configuration Instance.....	114
	Kompella VPWS Switch Configuration Instance.....	137
	Kompella VPWS Router Configuration Instance.....	157
2.3	Configuring VPLS.....	174
2.3.1	Introduction	174
2.3.2	Configuring Martini VPLS.....	177
2.3.3	Configuring Kompella VPLS	186
2.3.4	Configuring Other VPLS Parameters.....	194
2.4	Configuration Examples	198
2.4.1	Typical Examples of Martini VPLS Configuration for Switches	198
2.4.2	Typical Examples of Martini VPLS Configuration for Routers	212
2.4.3	Typical Examples of Kompella VPLS Configuration for Switches	223
2.4.4	Typical Examples of Kompella VPLS Configuration for Routers	240
3.	Configuring BGP/MPLS L3 VPN	263
3.1	Overview	263
3.1.1	Components of a BGP/MPLS VPN	264
3.1.2	Protocol Specifications.....	266
3.2	Configuration.....	266
3.2.1	Default Configurations	267
3.2.2	Configuring BGP/MPLS VPN.....	267
3.2.3	Configuring an Inter-AS VPN.....	276
3.2.4	Configure Carrier's Carrier (CSC)	296
3.2.5	Configure MPLS VPN Over GRE.....	305
3.2.6	Configure OSPF VPN extension.....	314
3.3	Verification	323

3.4	Configuration Examples	324
3.4.1	Intranet Configuration Example	324
3.4.2	Extranet Configuration Example	331
3.4.3	Configuration Example for Hub-and-Spoke	337
3.4.4	Internet Unified Egress Interface Configuration Example	344
3.4.5	Inter-AS VPN OptionB: Next Hop Unchanged	354
3.4.6	Inter-AS VPN OptionB: Next Hop Changed	359
3.4.7	Inter-AS VPN OptionC: Enabling IPv4 Label Exchange Between EBG Neighbors	362
3.4.8	Inter-AS VPN OptionC: Enabling IPv4 Label Exchange Between Both EBGP and IBGP Neighbors.....	366
3.4.9	Inter-AS VPN OptionC: RR Networking Scheme	369
3.4.10	CSC: Second Carrier provides Internet service based on IP core	375
3.4.11	CSC: Second Carrier provides Internet service based on MPLS core 383	
3.4.12	CSC: Second Carrier provides VPN service based on MPLS core ..	388
3.4.13	MPLS VPN over GRE.....	393
3.4.14	OSPF VPN configuration example	400
4.	Configuring MPLS GR.....	423
4.1	LDP GR.....	423
4.1.1	Overview.....	423
4.1.2	Configuration	426
4.1.3	Configuration Example.....	428
4.2	L3VPN GR	433
4.2.1	Overview.....	433
4.2.2	Configuration	438
4.2.3	Configuration Example.....	440
4.3	L2VPN GR	447
4.3.1	Overview.....	447
4.3.2	Configuration	452
4.3.3	Configuration Example.....	453
4.4	MPLS BFD	460
4.4.1	Overview.....	460

4.4.2	Configuration	465
4.4.3	Configuration Example.....	471
4.5	LDP FRR.....	479
4.5.1	Overview.....	480
4.5.2	Configuration	481
4.5.3	Configuration Example.....	483

1. CONFIGURING MPLS



Note The router icon in this chapter refers to the routers and the layer-3 switches with the routing protocol enabled.

1.1 Overview

In the Multiprotocol Label Switching (MPLS), the multiprotocol refers to various network layer protocols supported by an MPLS network, such as IP, IPv6, and IPX, and label switching indicates the addition of labels to packets and the forwarding of packets based on the labels. The MPLS is compatible with multiple link layer technologies including ATM, frame relay, Ethernet, and PPP. The MPLS works at both the connectionless control plane and the connection-oriented data plane and provides connection-oriented attributes to connectionless IP networks. The MPLS technology was first introduced to enhance the forwarding rate of routing devices. With the development of hardware technologies and network processors, this competitive edge has gradually lost its appeal. Due to the innate advantage of combining Layer 2 switching and Layer 3 routing technologies, however, the MPLS still has unprecedented edges over other technologies in terms of virtual private networks (VPNs) and traffic engineering (TE). The MPLS VPN is increasingly favored by carriers to address interconnection problems between companies and to provide various new services. It has already become an important means to provide value-added services on IP networks. At the same time, the MPLS TE technology also turns into a major method to reduce congestion and guarantee QoS on IP networks by managing network traffic. Therefore, the MPLS technology receives more and more attention and the MPLS applications gradually shift to MPLS VPN and TE applications.

- ❖ Basic Concepts
- ❖ Different from ILM, FTN maps each FEC to a series of NHLFEs, which indicates multiple paths. The FTN table is used for to LER to encapsulate a tag in a packet before the packet is forwarded when it receives an untagged packet.
- ❖ Label
- ❖ LDP
- ❖ MPLS Network
- ❖ The MPLS network comprises Label Switched Routers (LSRs) and Label Edge Routers (LERs). LSR is the core of the MPLS network and the Label Distribution Protocol (LDP) runs on the network to forward labeled packets. The LER makes Forwarding Equivalence Class (FEC) for packets entering the MPLS network, label the packets, and encapsulates them into MPLS packets. Before forwarding them, the LER removes the labels of the packets leaving the MPLS

network and restores them to the original packets. The labeled MPLS packets are forwarded through the established Layered Service Provider (LSP) with LDP.

The MPLS architecture is divided into the forwarding unit (data plane) and control unit (control plane). The forwarding unit forwards packets by searching the label forwarding information base (FIB) according to the labels on the packets. The control unit creates and maintains the label FIB between MPLS nodes. Each MPLS node must run one or multiple routing protocols (including static routing protocols) to exchange routing information with other MPLS nodes. From the control plane, the MPLS nodes are actually IP routers. Similar to a traditional IP router, a MPLS node uses unicast routing protocols (including static routing protocols) to establish and maintain a routing table. However, the MPLS node uses the routing table to exchange label binding information with other MPLS nodes with the same destination subnet. LDP is introduced to exchange label binding information.

- ❖ MPLS Forwarding Actions

- ❖ The MPLS forwarding procedure is as follows (IP routing for example):

1. All LSRs (including LERs) use routing protocols, such as OSPF and ISIS, and establish IP routing tables.

2. LDP creates an LSP according to the IP routing tables.

3. The ingress LER receives an IP packet, analyses the packet header, associates it with a FEC, labels the packet header with L1, and sends the labeled packet to the next-hop LSR through the LSP.

4. After receiving the packet, the next-hop LSR searches the LSP according to the label on the stack top, replaces the original label with the found label, and sends the packet to the next LSR of the LSP.

5. The following LSRs, except the last two LSRs, perform the same operations as step 4.

6. When the last hop but one LSR receives the labeled packet, it searches the label FIB, ejects the label, and forwards the packet to the last hop LSR if it finds that the egress label is an implicit empty label. If it finds that the egress label is an explicit empty label, the LSR ejects the label, selects routes according to the IP header, and forwards the packet.

7. If the last hop but one LSR ejects the label, the egress LER of the last hop receives the original IP packet and forwards the packet according to the IP routing table.

- ❖ LSP Setup and Loop Detection

- ❖ MPLS Applications

1.1.1 Basic Concepts

- ❖ MPLS node

The nodes enabled with MPLS can identify the MPLS signaling protocol (control protocol), support one or more Layer 3 routing protocols (including static routes), and forward packets based on MPLS labels. Generally speaking, an MPLS node is also capable of forwarding original Layer 3 packets (such as IP packets).

❖ Forwarding Equivalence Class (FEC)

FEC indicates one type of data packets that are handled in equal cost mode during the forwarding, such as data packets that have the same prefix in their destination addresses. The FEC supports different classification methods for different applications. For example, the FEC classifies IP unicast routes based on the address prefixes. That is, one route corresponds to one FEC. All the packets in the same FEC are equally handled on the MPLS network.

❖ Label Switching Router (LSR)

As a core device on an MPLS network, the LSR provides label switching and distribution functions. As specified by RFC 3031 for MPLS system files, the LSR is also an MPLS node that is capable of forwarding original Layer 3 packets (such as IP packets or IPv6 packets). For the MPLS on an IP network, this means that the LSR can also forward normal IP packets.

❖ Label Switching Edge Router (LER)

Located on the edge of an MPLS network, the LER identifies different FECs for incoming traffic, requests labels for these FECs, and restores the original packets for outgoing traffic by popping out the labels. The LER thus provides traffic classification, label mapping, and label removal functions.

❖ Label Switched Path (LSP)

One FEC data stream is assigned with specific labels on different nodes and transmitted along the nodes according to the switching of assigned labels. The path that the data stream travels is an LSP. It is a collection of several LSRs. In this manner, you can consider the LSP as a tunnel that traverses the MPLS core network.

❖ Next Hop Label Forwarding Entry (NHLFE)

The NHLFE table is used to store the next-hop information about MPLS packets. The NHLFE entries generally cover the following information:

1. Next hop of data packets
2. Link layer encapsulation of data packets to be forwarded
3. Encoding method in the label stack of data packets to be forwarded
4. Operations to the label stack of data packets, including:
 - a) Replacing the label of the label stack top with a new label
 - b) Popping out the label of the stack top
 - c) Adding one or more labels
 - d) Replacing the label of the label stack top with a new label and adding one or more new labels

❖ Incoming Label Map (ILM)

The ILM table is a label forwarding table that maps each incoming label to a series of NHLFEs (multiple NHLFEs indicate multiple paths). The ILM is applied when an LSR receives and forwards MPLS packets with labels.

❖ FEC-to-NHLFE (FTN)

Different from ILM, the FTN maps each FEC to a series of NHLFEs (multiple NHLFEs indicate multiple paths). The FTN table is used when an LER receives and forwards packets without labels and is required to encapsulate labels to the packets before forwarding them.

1.1.2 Label

A label is a short identifier with fixed length and of local significance. The label is distributed and transmitted only between two adjacent LSRs. As a result, it is valid only between the two LSRs. One label identifies one FEC. When arriving at the MPLS ingress, packets are classified into different FECs according to certain rules. Based on the FECs, the packets are encapsulated with different labels and then forwarded on the MPLS network based on the labels.

1.1.2.1 Label Structure

Figure 1 Encoding structure of an MPLS label



As shown in the preceding figure, a label consists of four fields. The following introduces the four fields separately:

❖ Label field

The label field is used to save the label that is 20 bits long. The label value is an index to the forwarding table of labels. The IETF defines 0 to 15 as reserved labels and predefines the meanings of these label values:

Reserved Label Value	Meaning
0	Indicates the IPv4 explicit null label. According to RFC 3032, the 0 label must be at the stack bottom. This means that the label should be popped out and the packets should then be forwarded according to destination IP addresses. RFC 4182 modifies the description of 0 label in RFC 3032. For the received packets with 0 label, the router directly pops out the label and determines the forwarding action based on the contents after 0 label. If another label follows, the router forwards the packets according to the label; if the packets are IPv4 packets, the router forwards them according to their destination IP addresses.
1	Indicates the router alert label. This label is not allowed at the bottom of the label stack. When receiving packets with the router alert label, the router must send the packets to the local software module for processing. The actual forwarding of the packets must be based on the labels that follow the router alert label. Before the forwarding, however, the router alert label must be added to the label stack again. This option is similar to the Router Alert Option of IP packets. You can use this option to configure the LSRs on each hop to check MPLS packets.
2	Indicates the IPv6 explicit null label. According to RFC 3032, the 2 label must be at the stack bottom. This means that the label should be popped out and the packets should then be forwarded according to destination IP addresses. RFC 4182 modifies the description of 2 label in RFC 3032. For the received packets with 2 label, the router directly pops out the label and determines the forwarding action based on the contents after 2 label. If another label

	follows, the router forwards the packets according to the label; if the packets are IPv4 packets, the router forwards them according to their destination IP addresses.
3	Indicates the implicit null label. This label can be distributed by the label distribution protocol (LDP) but can never be transmitted in the label stacks of MPLS packets. When an LSR exchanges MPLS packets, the router pops out the label of the stack top rather than replaces the label if the label to be replaced at the stack top is 3. The implicit null label is used in the Penultimate Hop Popping (PHP) function.
4 to 15	These values are reserved by the IETF for future usage.

❖ Exp field

The Exp field is currently used to store the QoS information about MPLS. This field is 3 bits.

❖ S mark

The S mark field indicates the stack bottom. It is one bit long. If multiple labels exist, the S bit at the stack bottom is set to 1 and the S bits of other labels are 0. If only one label exists, the S bit is directly set to 1.

❖ TTL

Short for Time To Live, the TTL field is 8 bits long. It is similar to the TTL value in IP packet headers. When a label is first added to an IP packet, the TTL value can be copied from the TTL field (or HopLimit of IPv6) of the IP packet header. The TTL value of the outer (stack top) label then decreases by one at every label switching. When MPLS runs on ATM links, the label encoding methods are different and no TTL field exists. For the corresponding methods and solutions, refer to RFC 3032.

1.1.2.2 Label Stack

One MPLS packet can have several labels, that is, a label stack. The label that is close to the link layer header is the top label and the label that is next to the IP header is the bottom label. The LSR always exchanges labels based on the top label. When multiple labels exist, each label must be complete and have 32 bits. With the label stack, one MPLS packet can carry multiple layers of labels. In this manner, the MPLS technology can support hierarchical network systems and at the same time, support LSPs.

1.1.2.3 Operation Methods of Labels

There are the following basic label operations on MPLS nodes:

❖ Push

Insert a label to the link header and network layer header on an ingress LER or add a new label to the stack top of an MPLS packet on an intermediate LSR.

❖ Pop

Remove the label of packets on the egress LER to restore the IP packets or remove the top label on an intermediate LSR to reduce the layers of a label stack.

❖ Swap

Replace the top label in the label stack of packets based on the ILM during forwarding.

1.1.2.4 LDP

As a new network system, MPLS also has its own signaling protocols or "routing protocols". One of the basic concepts in the MPLS system is that two LSRs must reach consensus on the meaning of labels used for traffic transmission. This consensus is realized through a series of processes, that is, the LDP. Through the LDP, one LSR can notify the other LSR of the label binding. The MPLS system architecture does not assume the existence of a single LDP. Some MPLS systems use independent distribution protocols, such as the LDP defined in RFC 3036 by the IETF; other MPLS systems support the distribution of labels by extending existing protocols in piggybacking mode, such as MP-BGP and RSVP. You can choose different LDPs for MPLS networks based on the different application scenarios.

1.1.3 MPLS Network

Figure 2

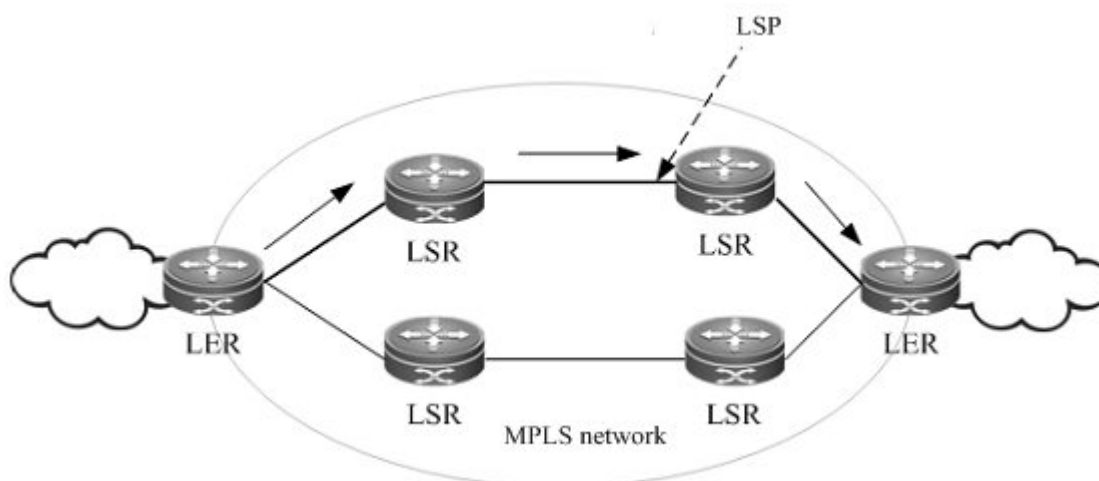

An MPLS network has two basic components: LSR and LER. The LSR, which is located at the core MPLS network, runs the LDP and forwards packets based on labels. The LER classifies incoming packets into FECs, adds labels, and encapsulates the labels as MPLS packets for forwarding. The LER also removes the labels from outgoing MPLS packets and restores the original packets. On the MPLS network, packets with labels are forwarded along the LSP set up through the LDP.

The MPLS system architecture can be divided into the forwarding unit (data plane) and control unit (control plane). The former forwards packets by searching the label forwarding database based on the labels carried in packets whereas the latter is responsible for creating and maintaining label forwarding information database between the connected MPLS nodes. Each MPLS node must run one or more routing protocols (including static routes) to exchange routing information with other MPLS nodes on the MPLS network. Judged from the control plane, each

MPLS node is in nature an IP router. Similar to a traditional IP router, unicast routing protocols (including static routes) are also enabled to create and maintain a routing table on an MPLS node. The traditional router uses the routing table to create a forwarding table. The MPLS node, however, uses the routing table to exchange label binding information between each destination subnet and adjacent MPLS nodes. The protocol that is responsible for exchanging label binding information is the LDP.

1.1.4 MPLS Forwarding Actions

Figure 3 Forwarding process of MPLS packets that support PHP

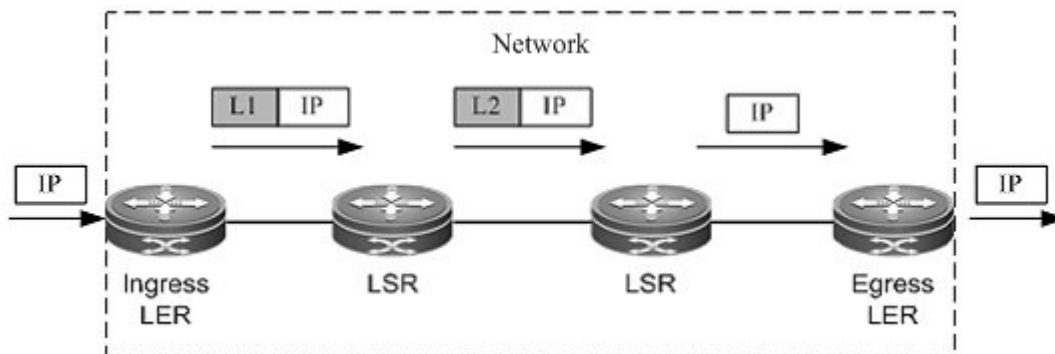

The following takes traditional IP routing services as an example to show the MPLS forwarding process:

- ❖ Enable traditional routing protocols (OSPF or ISIS) on all LSRs (including LERs) and create IP routing tables on the LSRs and LERs.
- ❖ Set up an LDP LSP based on the IP routing table.
- ❖ Upon receipt of an IP packet, the ingress LER analyzes the IP packet header and maps it to an FEC. The ingress LER then adds the label L1, to which the FEC corresponds, to the packet and sends the labeled packet to the next hop LSR along the LSP.
- ❖ The next-hop LSR receives the labeled packet, searches the LSP based on the label of the stack top, and then forwards the packet to the next-hop LSR on the LSP after replacing the label.
- ❖ The intermediate LSRs perform the same actions as 4.
- ❖ Upon receipt of the labeled packet, the PHP LSR searches the label forwarding table and pops out the label after learning that the outgoing label is the implicit null label 3. The PHP LSR then forwards the original IP packet to the last-hop LSR. If the outgoing label is the explicit null label, the PHP LSR pops out the label and directly sends the original packet based on the routes of the IP header in the IP forwarding table.
- ❖ If the label is popped out on the PHP LSR, the last-hop egress LER receives the original IP packet and forwards it according to the IP routing table.

1.1.5 LSP Setup and Loop Detection

The pseudo MPLS wire is an LSP. One FEC data stream is assigned with different labels on different MPLS nodes and forwarded according to the labels. The path that the data stream travels is an LSP that consists of a series of LSRs. The data streams of the same FEC pass through the same LSP.

- ❖ LSP Setup
- ❖ LSP Loop Control

1.1.5.1 LSP Setup

The LSP setup is in fact the process of binding the FEC to a label and notifying adjacent LSRs of the binding. This process is completed by the LDP. RFC 3036 stipulates the protocol specifications of LDP, the interactive process of LSRs, and the message formats.

The LDP detects adjacent LSRs by periodically sending Hello packets. The LDP Hello packets adopt UDP encapsulation and use the well-known port 646 as the destination port. The destination address of these packets is the multicast address of all routers in the subnet (the corresponding IP address is 224.0.0.2). Upon the discovery of a neighboring LSR, the LDP session is triggered. Setting up an LDP session involves two steps:

- ❖ Set up a transmission connection. This is in fact the completion of TCP three-way handshakes that do not require any interaction of LDP messages.
- ❖ Initialize the session. The LDP session parameters are negotiated and determined by exchanging the initialization information of both parties, such as the label distribution mode, Keepalive duration, and the maximum length of Protocol Data Unit (PDU).

After the LDP session is created and both parties enter the Operational status, the two parties can exchange label messages to distribute and manage labels, and create an LSP for each FEC.

During the LSP setup process, there are two label distribution modes: Downstream on Demand (DOD) and Downstream Unsolicited (DU). In DOD mode, one LSR responds to a label binding message only after the receipt of a label request from an adjacent LSR. In DU mode, one LSR voluntarily sends label binding messages to its adjacent LSRs without receiving any request.

During the LSP setup process, there are two label control methods: independent and ordered control. In independent control mode, each LSR announces to its adjacent devices the binding of labels and FECs at any required time. In independent DOD mode, one LSR can immediately answer an upstream label mapping request without waiting for the label mapping from the next hop device. In independent DU mode, one LSR can announce the label mapping of an FEC at any time deemed as proper.

In ordered control mode, one LSR binds an FEC to a label and sends the binding upstream only when the FEC has the next-hop label mapping or the LSR is the egress of the FEC. Otherwise, the LSR does not bind the FEC to a label, or send the binding to an upstream LSR until receiving the label mapping of the FEC from a downstream LSR. In ordered control and DU mode, one LSR announces the label to an upstream LSR only when the LSR is the egress of the FEC or the LSR receives the label distributed by a downstream LSR. If the label distribution mode of the

downstream LSR is DOD, the LSR, either in DOD or DU mode, passes on the label request from an upstream LSR to downstream devices.

1.1.5.2 LSP Loop Control

During the LSP setup process, the loop detection mechanism must be provided to ensure timely detection of any loops formed by the LSP. There are two methods to avoid LSP loops: the maximum number of hops and path vector.

In the former mode, the messages that transmit label binding information record the number of bypassing LSRs. The number increases by one after every LSR. If the number exceeds the specified maximum value, the system considers that a loop occurs and terminates the LSP.

In the latter mode, the messages that transmit label binding information record the IDs of bypassing LSRs. The ID of an LSR is recorded to the vector table of the message after each LSR. Upon receipt of a label binding message, an LSR checks whether its own ID is included in the vector table. If not, the LSR adds its own ID to the record when distributing the message; if yes, the LSR considers that a loop occurs and terminates the LSP.

1.1.6 LDP Inter-Area LSP

1.1.6.1 Overview

When an autonomous system (AS) is grouped into multiple interior gateway protocol (IGP) domains, route aggregation is configured on area border routers (ABRs) to reduce the size of routing tables and improve efficiency. To configure route aggregation on ABRs, you adopt the LDP inter-area LSP technology to build a label switch path for aggregated host routes across multiple IGP areas in an AS.

LDP inter-area LSP achieves this by performing maximum route match extension for LDP.

1.1.6.2 Basic Concepts

Inter-Area LSP

The Inter-area LSP refers to the label switch path across multiple IGP areas in an AS.

ABR

The ABR is a node to connect the backbone area and other areas in OSPF and is a Level 1 or Level 2 node of ISIS.



Note When an AS is grouped into multiple IGP areas and route aggregation is enabled on an ABR, enable LDP inter-area LSP to build a label switch path across multiple IGP areas on the ABR.

1.1.6.3 Working Principle

If LDP inter-area LSP is not enabled, LDP only forwards packets of labels with the exact matching routes and assigns label mapping messages to LDP neighbors. If LDP inter-area LSP is enabled,

there is a FEC maximum matching route in the routing table, and the neighbor to which LDP will assign label mapping messages is the next hop of the maximum matching route, LDP adds the corresponding forwarding entry, and assigns label mapping messages to the LDP neighbor. The FEC refers to that in the received label mapping message but not that obtained from the routing table.

The following figure shows the process for building an LDP inter-area LSP:

Figure 4

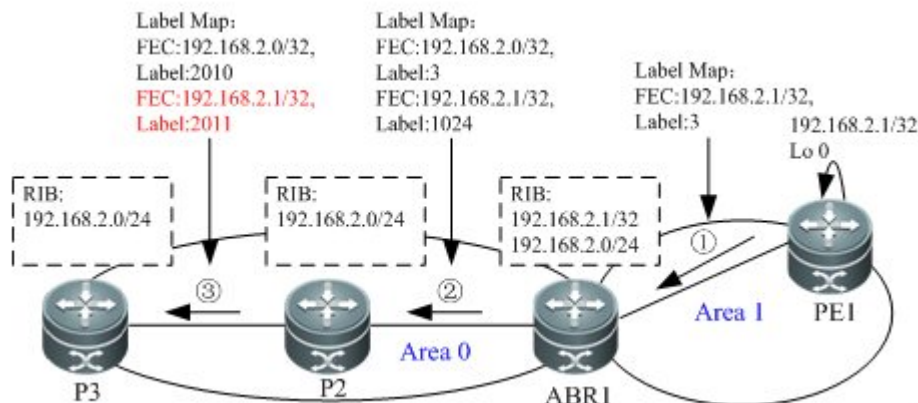

The process is as follows:

- ❖ Configure ABR1 to advertise route aggregation to the backbone area. The routing table of ABR1 contains the aggregated route 192.168.2.0/24 and the host route 192.168.2.1/32.
- ❖ PE1 sends a FEC (label mapping message of 192.168.2.1/32) to ABR1.
- ❖ ABR1 sends a FEC (label mapping messages of 192.168.2.0/24 and 192.168.2.1/32) to the upstream node P2.
- ❖ The routing table of P2 contains the aggregated route 192.168.2.0/24. When receiving the label mapping message of 192.168.2.0/24, it sends a label mapping message to the upstream node P3. When receiving the label mapping message of 192.168.2.1/32, P2 sends a label mapping message of 192.168.2.1/32 to the upstream node P3, because the routing table contains a maximum matching route (192.168.2.0/24) with the FEC and the neighbor (ABR1) to which the label mapping message is assigned is the next hop of the route.
- ❖ P3 performs the same as P2.
- ❖ After the preceding steps, an inter-area LSP, which is P3-P2-ABR1-PE1 (192.168.2.1/32) is established between Area 0 and Area 1.

This method is similar to the DU label assignment mode + Ordered label assignment control mode. The LSP built in this mode is applicable to IGP shortest path. Because only aggregated routes are available for the upstream, DOD label assignment is not applicable to LDP inter-area LSP.

To delete a MPLS forwarding entry added because of the maximum matching route, which is indicated in the label removal message or because the maximum matching route is deleted, you

must deliver label removal messages to the upstream, regardless of the label assignment control mode, Ordered mode or Independent mode. The following figure shows the process for removing an LDP inter-area LSP:

Figure 5

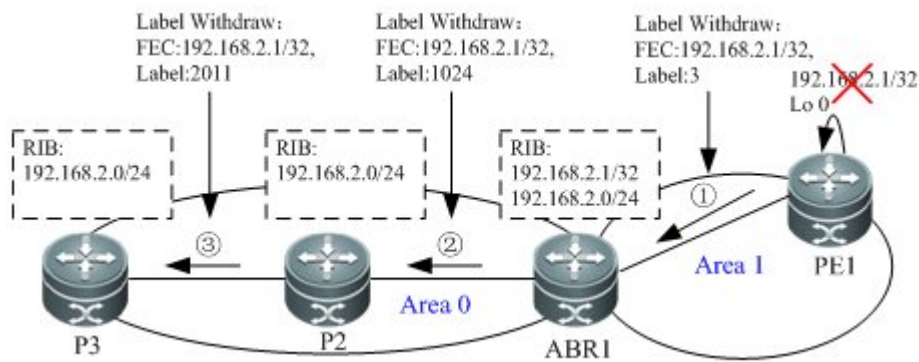

The route platform advertises LDP maximum matching route update or removal once the route of the MPLS forwarding entry added because of the maximum matching route changes, to ensure more exact LSP.

1.1.6.4 Protocols and Standards

RFC 5283: LDP Extension for Inter-Area Label Switched Paths (LSPs)

1.1.7 LDP Session Protection

1.1.7.1 Overview

The link failure may greatly influence route convergence and aggregation, because the Hello adjacency of the LDP session is disconnected and the LDP session is disconnected. When the link is recovered, the LDP session is re-established and label bindings are re-switched, resulting in low efficiency of LDP convergence.

The LDP session protection function protects the LDP sessions between directly-connected LSRs and LDP over TE. It speeds up LDP convergence when a link is recovered, especially when a link fails for a short time.

1.1.7.2 Working Principle

When LDP session protection is enabled for two directly-connected LSRs, a Hello adjacency connection is established between the LSRs. If the link between them fails, the extended Hello adjacency connection can be maintained as long as a replaceable path is available between them. A basic Hello adjacency may be disconnected when a link fails, but the extended Hello adjacency connection maintains the LDP session. When the link is recovered, the LSR does not need to establish a new LDP session, improving the LDP convergence efficiency.

Figure 6 LDP session protection

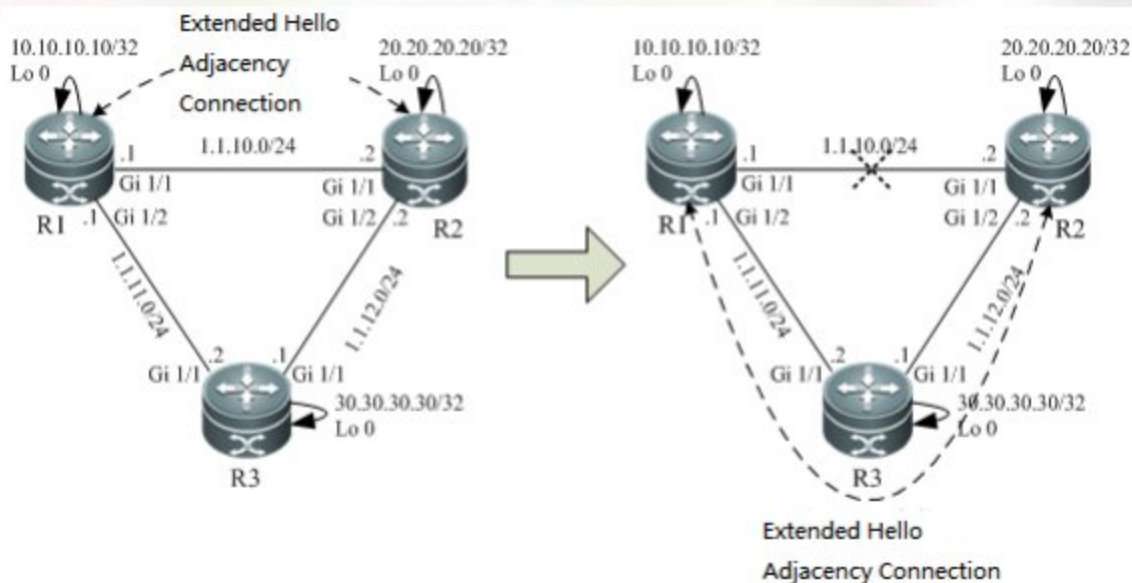

As shown in the figure, devices R1, R2, and R3 can communicate with each other at the data link layer and are enabled with OSPF. LDP is enabled on R1 and R3. A basic Hello adjacency connection is established between R1 and R2. To protect the LDP session between R1 and R2, enable LDP session protection on them to establish an extended Hello adjacency connection between them.

When the link between R1 and R2 fails, the basic Hello adjacency connection is disconnected, but the path R1-R3-R2 is available for reaching R2. As a result, the extended Hello adjacency connection maintains the LDP session.

No new LDP session or label switch binding is needed when the link between them is recovered.

1.1.8 Applications

Thanks to the combination of Layer 2 switching and Layer 3 routing technologies, the MPLS technology improves the forwarding rate of packets. With the development of the Application-Specific Integrated Circuit (ASIC) technologies, the forwarding rate is no longer a bottleneck in network development. As a result, the edges of MPLS in enhancing forwarding rates are not remarkable. Due to the innate advantage of combining Layer 2 switching and Layer 3 routing technologies, however, MPLS still has unprecedented edges over other technologies in terms of virtual private networks (VPNs) and traffic engineering (TE). In this context, MPLS receives more and more attention. The MPLS applications also gradually shift to the application areas of MPLS VPN and MPLS TE.

1.2 Configuration

To configure basic MPLS forwarding functions, perform the following configuration procedures:

- ❖ Enabling MPLS Globally (Mandatory)
- ❖ Enabling LDP Globally (Mandatory)
- ❖ Enabling Label Switching on an Interface (Mandatory)

- ❖ Enabling LDP on an Interface(Mandatory)
- ❖ Configuring MPLS MTU on an Interface (Optional)
- ❖ Fragmenting MPLS Packets (Optional)
- ❖ Handling ICMP Error Messages (Optional)
- ❖ Configuring the MPLS TTL Replication Function (Optional)
- ❖ Verifying the MPLS Information (Optional)



Caution

1. The LDP is a topology-driven protocol. To ensure the normal working of the LDP, you should enable IPv4 routing protocols and ensure their normal operations.
2. For the router products, the **ip ref** command must be used in the interface configuration mode to enable the router MPLS express forwarding function and improve the forwarding performance.

1.2.1 Enabling MPLS Globally

In the configuration mode, you can run the **mpls ip** command to enable a device to support MPLS forwarding. By default, MPLS is disabled on a device. After MPLS is enabled, the device first forwards packets according to their labels rather than IP addresses. When the label forwarding fails, the device then attempts to forward packets based on their IP addresses.

Run the **no mpls ip** command to disable MPLS forwarding.

Command	Function
Qtech(config)# mpls ip	Enable MPLS globally.
Qtech(config)# no mpls ip	Disable MPLS globally.

- For QSW-6510 series products, the **mpls ip** command (global configuration mode) is not used to control the chip forwarding but to control the software forwarding.

1.2.2 Enabling LDP Globally

In the global configuration mode, you can first use the **mpls router ldp [vrf-name]** command to enable LDP for a VRF instance and enter the LDP configuration mode.

Run the **no mpls router ldp [vrf-name]** command to disable LDP for a VRF instance.

Command	Function
Qtech(config)# mpls router ldp [vrf-name]	Enable LDP for a VRF instance and enter the LDP configuration mode.
Qtech(config-mpls-router)# ldp router-id interface loopback id [force]	Configure the LDP router ID. The loopback address is generally used as the router ID.
Qtech(config)# no mpls router ldp [vrf-name]	Disable LDP for a VRF instance.



Caution

After LDP is enabled globally, you still need to run the **mpls ip** command in the interface mode to enable LDP for an interface.

If no *vrf-name* is entered, LDP is globally enabled for all VRF instances.

You are generally required to specify the router ID for an LDP when you enable LDP.

1.2.3 Enabling Label Switching on an Interface

By default, interfaces do not forward MPLS packets. In the global configuration mode, you can use the **mpls ip** command to enable MPLS on a device. You should also use the **label-switching** command to explicitly enable MPLS on a specified interface.

Command	Function
Qtech(config-if-type ID)# label-switching	Enable MPLS on an interface.
Qtech(config-if-type ID)# no label-switching	Disable MPLS on an interface.

- For the router products, the **ip ref** command must be used in the interface configuration mode to enable the router MPLS express forwarding function and improve the forwarding performance.
- If you enable label forwarding in a VLAN on the switch, there must be only one member port. Otherwise, packets cannot be flooded in the VLAN.
- When unknown unicast packets or broadcast packets enter the switch through a port, if label forwarding is enabled in the VLANs where the port belongs, the packets in the VLANs (including VLANs without label forwarding enabled) cannot be forwarded. Qtech Networks recommends that you enable label forwarding on routing ports but not in VLANs.



Note

After you disable MPLS packets forwarding on a public network interface, packets forwarding from the AC to the PW is not affected.

1.2.4 Enabling LDP on an Interface

After LDP is globally enabled, you should run the **mpls ip** command in the interface mode to enable LDP on an interface.

Command	Function
Qtech(config-if-type ID)# mpls ip	Enable LDP on an interface.
Qtech(config-if-type ID)# no mpls ip	Disable LDP on an interface.



Caution

After LDP is enabled in the interface mode, the LDP does not take effect on an interface if the **mpls router ldp** command is not used in the global configuration mode to enable LDP. To enable LDP on the interface, you must also use the **label-switching** command to enable MPLS on the interface.

1.2.5 Configuring MPLS MTU on an Interface (Optional)

By default, the MTU of MPLS packets that can be transmitted by an interface is the same as the MTU of the interface. The MPLS MTU determines whether MPLS packets should be fragmented during the forwarding. The MPLS MTU indicates the overall length of MPLS encapsulation and encapsulated (such as IP) layers.

Run the **no mpls mtu** command to restore the default value of the MPLS MTU on an interface.

Command	Function
Qtech(config-if-type ID)# mpls mtu bytes	Configure the MPLS MTU on an interface.
Qtech(config-if-type ID)# no mpls mtu	Restore the default value of the MPLS MTU on an interface.

- For QSW-6510 series products, the MPLS MTU configured on an interface cannot exceed the size of packets transmitted on the interface. For the switches adopting ASIC forwarding, this configuration is invalid. The switches forward packets based on the MTU configured on actual interfaces and directly discard the packet whose size exceeds the MTU. To modify the MTU of an interface, you can use the **mtu** command in the interface configuration mode. Fragmentation is supported by only process forwarding and router forwarding. You should adjust the MTU value according to the actual application to avoid performance degradation due to fragmentation.

1.2.6 Fragmenting MPLS Packets (Optional)

By default, MPLS packets that exceed the MPLS MTU on an interface are fragmented as IP fragmentations. The fragmented IP packets are still encapsulated with the original labels and transmitted along the original LSP.

Run the **no mpls ip fragment** command to directly discard packets that should be fragmented.

Command	Function
Qtech(config)# no mpls ip fragment	Directly discard MPLS packets that exceed the MPLS MTU on an interface.
Qtech(config)# mpls ip fragment	Restore the default value to fragment packets that exceed the MPLS MTU on an interface.



Note

This command is valid only for the encapsulated IP packets. It is invalid for non-IP packets.

- This configuration is invalid for MPLS service forwarding with MPLS multi-service cards, such as M8600-MPLS. The packets exceeding the interface MTU cannot be forwarding and are discarded. Only process forwarding supports fragment.

1.2.7 Handling ICMP Error Messages (Optional)

To handle ICMP error messages (such as typical MPLS TTL timeout messages) generated during the forwarding of MPLS packets, you can use the `mpls ip icmp-error pop labels` command to provide different processing methods for MPLS packets with different numbers of labels. The default value of labels is 1. This indicates that the ICMP error messages generated by MPLS packets with a single layer of labels are forwarded through the global routing table. The ICMP error messages generated by MPLS packets with multiple layers of labels are forwarded along the LSP of the original label stack.

Command	Function
Qtech(config)# <code>mpls ip icmp-error pop labels</code>	Control ICMP error messages generated by labeled MPLS packets.
Qtech(config)# <code>no mpls ip icmp-error pop</code>	Restore the default value.

1.2.8 Configuring the MPLS TTL Replication Function (Optional)

There are two modes for handling the TTL of encapsulated and de-encapsulated IP (or MPLS) packets on an MPLS network:

- ❖ TTL replication mode: This is the default working mode. The procedure is as follows: When a label is pushed, the label TTL copies the TTL of the existing IP or MPLS header to the TTL field of the label. When a label is popped out, the TTL is copied back from the external label to the inner IP packet or MPLS packet.
- ❖ TTL non-replication mode: In this mode, the TTL is not copied. The procedure is as follows: When a label is pushed, the TTL value of the label is directly set as 255. When a label is popped out, the original TTL value of the inner IP packet or MPLS packet is exposed and retained.

Run the `mpls ip ttl propagate { public | VPN }` command to configure the TTL replication function for packets sent and forwarded by a device.

Command	Function
Qtech(config)# [<code>no</code>] <code>mpls ip ttl propagate public</code>	Enable or disable the TTL propagate for MPLS packets sent by the device.
Qtech(config)# [<code>no</code>] <code>mpls ip ttl propagate VPN</code>	Enable or disable the TTL propagate for MPLS service packets forwarded by the device.

After the TTL replication function is enabled on an MPLS network, you can use the Tracert tool on a CE to track all the LSRs that the packets pass through in the MPLS domain. If the TTL non-replication mode is configured on PEs, the entire LSP of the packets is considered as only one hop.

- ☑ For QSW-6510 series products, TTL in the inner header is copied after TTL replication is enabled, whether it is smaller than the TTL in the outer header.

1.2.9 Verifying the MPLS Information

You can use the show commands in the privilege mode to display MPLS information and verify the configuration results.

- ❖ Display MPLS information.

Display the utilization information about the label space and the interfaces enabled with MPLS. You can verify whether the configurations are accurate based on the information.

Command	Function
Qtech# show mpls summary	Display basic MPLS information.

- ❖ Display the MPLS forwarding table.

Display the contents of MPLS forwarding entries and the contents of MPLS forwarding entries added to an MPLS application protocol (such as LDP and MP-BGP).

Command	Function
Qtech# show mpls forwarding-table [summary] [[<i>ip-address/mask</i> label label interface interface-name next-hop ip-address] [ftn [ip vc] ilm [ip vc]] { vrf vrf-name global } [ftn ilm]] [frr] [detail]]	Display the information about the MPLS forwarding table.

- ❖ Display the utilization of the label pool.

Command	Function
Qtech# show mpls label-pool	Display information about the utilization of the MPLS label pool.

- ❖ Check the LSP connectivity.

Command	Function
Qtech# ping mpls ipv4 <i>ip-address/mask</i> [repeat repeat] [tll time-to-live] [timeout timeout] [size size] [interval mseconds] [source ip-address] [destination ip-address] [force-explicit-null] [pad pattern] [reply mode { ipv4 router-alert }] [dsmap] [flags fec] [verbose]	Check the LSP connectivity.
Qtech# tracert mpls ipv4 <i>ip-address/mask</i> [timeout timeout] [tll tll] [source ip-address] [destination ip-address] [force-explicit-null] [reply mode { ipv4 router-alert }] [flags fec] [verbose]	Check the LSR nodes that the LSP passes through.

1.2.10 Configuring Optional LDP Parameters (Optional)

You can modify the default LDP parameters as required. To modify LDP parameters, you should run the commands in the LDP or the interface configuration mode.

1.2.10.1 Configuring Parameters for an LDP Session

Configuring the LDP Router ID

The LDP Router ID, expressed in the format of IP addresses, uniquely identifies one LSR in a domain. By default, the LDP uses the system Router ID as the LDP Router ID, that is, the LSR ID. The value of an LDP Router ID must be globally unique. In addition, the LDP Router ID must be reachable to other LSRs. This is because the LDP defaults the LDP Router ID as the transport address. You can run the `ldp router-id` command to modify the LSR ID.

Command	Function
<code>Qtech(config-mpls-router)# ldp router-id interface interface-name [force]</code>	Specify the address of an interface as the LDP Router ID of the LSR. force indicates that the current configurations immediately take effect.
<code>Qtech(config-mpls-router)# no ldp router-id</code>	Restore the default value. The system Router ID is used as the LDP Router ID.

Enabling Hello Packets Receiving

To enable the device to receive all target hello packets or the target hello packets from the neighbor permitted by the ACL, use the following command in the **config-mpls-router** mode.

Command	Function
<code>Qtech(config-mpls-router)# discovery targeted-hello accept [from acl-name]</code>	Use this command to enable the device to receive all target hello packets or the target hello packets from the neighbor permitted by the ACL. All other targeted hello packets are discarded except for those from the extended LDP neighbors. This function is disabled by default. Use the no or default form of this command to restore the default setting. from: Only receives target hello packets from the neighbor permitted by the ACL. <i>acl-name:</i> The ACL name.

When you configure two devices as remote peers, configure one end as neighbor and enable this function on the other. When you delete remote peers, you only need to delete the neighbor configuration.

The following example enables the device to receive target hello packets from all devices.

```
Qtech(config)# mpls router ldp
Qtech(config mpls router)# discovery targeted hello accept
```

The following example enables the device to receive target hello packets from neighbor 1.1.1.1.

```
Qtech(config)# ip access list standard target_acl
Qtech(config std nacl)# permit host 1.1.1.1
```

```
Qtech(config std nacl)# exit
Qtech(config)# mpls router ldp
Qtech(config mpls router)# discovery targeted hello accept from target_acl
```

Configuring transport-address

By default, the LSR ID is used as the global transport address. As an option, you can choose the main address of an interface or specify an IP address as the transport address to set up an LDP session on the interface. There are the following two configuration methods.

Use commands to configure the transport address of an interface.

Command	Function
Qtech(config-if-type ID)# mpls ldp transport-address { interface ip-address }	Configure the transport address for LDP sessions on an interface.
Qtech(config-if-type ID)# no mpls ldp transport-address	Delete the configuration on the interface. By default, the global transport address is adopted. If no global transport address is configured, the LSR ID is used as the transport address.

Use commands in the LDP configuration mode to globally configure a transport address for all LDP sessions.

Command	Function
Qtech(config-mpls-router)# transport-address { interface ip-address interface-name }	Configure a global transport address for LDP sessions.
Qtech(config-mpls-router)# no transport-address	Remove the global setting and restore the LSR ID as the transport address.



Caution

When you specify an IP address as the transport address, make sure that the address is reachable to other directly connected LSRs; otherwise, the LDP session cannot be set up.

If transport addresses are configured on an interface and globally, the basic LDP session set up on the interface prefers the transport address configured for the interface.

The configured transport address is valid only for the basic LDP session. The LDP session set up through extended mechanisms always use the LSR ID as the transport address.

Configuring the Time Interval for Hello Packets

The LDP periodically sends Hello packets to detect LDP peers. By default, the interval for sending Hello packets in the basic LDP discovery mechanism is 5s. You can freely set the interval that ranges from 1 to 65535 seconds in the interface mode.

Command	Function
Qtech(config-if-type ID)# mpls ldp hello-interval seconds	Set the interval for sending Hello packets in the basic LDP discovery mechanism.

Qtech(config-if-type ID)# no mpls ldp hello-interval	Restore the default interval for sending Hello packets in the basic LDP discovery mechanism.
---	--

The default interval for sending Hello packets in the extended LDP discovery mechanism is 10s. You can run the discovery target-hello interval command to modify the interval.

Command	Function
Qtech(config-mpls-router)# discovery target-hello interval seconds	Set the interval for sending Hello packets in the extended LDP discovery mechanism.
Qtech(config-mpls-router)# no discovery target-hello interval	Restore the default interval for sending Hello packets in the extended LDP discovery mechanism.

Configuring the Hold Time of Hello Packets

After an LDP peer is detected by periodically sending Hello packets, the local LDP device retains the peer for a period of time although no Hello packet is received from the peer, and considers that the peer expires after this period. This period of time is called the hold time of Hello packets. The default hold time of Hello packets is 15s. You can freely set the interval that ranges from 1 to 65535 seconds in the interface mode. The value 65535 indicates an indefinite hold time.

Command	Function
Qtech(config-if-type ID)# mpls ldp hello-holdtime seconds	Set the hold time of Hello packets.
Qtech(config-if-type ID)# no mpls ldp hello-holdtime	Restore the default hold time of Hello packets.

The default hold time of Hello packets in the extended LDP discovery mechanism is 45s. You can run the discovery target-hello holdtime command to modify this value.

Command	Function
Qtech(config-mpls-router)# discovery target-hello holdtime seconds	Set the hold time of Hello packets in the extended LDP discovery mechanism.
Qtech(config-mpls-router)# no discovery target-hello holdtime	Restore the default hold time of Hello packets in the extended LDP discovery mechanism.

Configuring the Hold Time of Keepalive Packets

After an LDP peer is detected by periodically sending Hello packets and an LDP session is set up in TCP mode, the local LDP device retains the peer for a period of time although no Keepalive packet is received from the peer. The local LDP device considers that the peer expires and voluntarily terminates the LDP session after this period. This period of time is called the hold time of Keepalive packets. The default hold time of Keepalive packets for the session set up in the basic discovery mechanism is 45s and that for the session set up in the extended discovery mechanism is 180s. You can freely set the value at the range of 15 to 65535. The interval for sending Keepalive packets is one third of the hold time of Keepalive packets.

Command	Function
Qtech(config-if-type ID)# mpls ldp keepalive-holdtime seconds	In the interface mode, set the hold time of Keepalive packets for the session set up in the basic discovery mechanism.

Qtech(config-if-type ID)# no mpls ldp keepalive-holdtime	Restore the default hold time of Keepalive packets for the session set up in the basic discovery mechanism.
Qtech(config-mpls-router)# targeted-session holdtime seconds	In the LDP mode, set the hold time of Keepalive packets for the session set up in the extended discovery mechanism.
Qtech(config-mpls-router)# no targeted-session holdtime	Restore the default hold time of Keepalive packets for the session set up in the extended discovery mechanism.

Configuring the Maximum Number of Repeated Label Requests

When an LDP device requests labels, it waits for a period of time to start another attempt if no label is detected due to various reasons. The default number of repeated requests is indefinite. You can freely set the value that ranges from 0 to 255 in the interface mode.

Command	Function
Qtech(config-mpls-router)# mpls ldp max-label-requests times	Set the maximum number of repeated LDP label requests.
Qtech(config-mpls-router)# no mpls ldp max-label-requests	Restore the default number of repeated LDP label requests.

Configuring the Maximum PDU

The messages exchanged between LDP devices are all contained in PDUs. You can freely set the value of the PDU that ranges from 256 to 4096 in the interface mode. The default PDU value is 4096.

Command	Function
Qtech(config-mpls-router)# mpls ldp max-pdu max-pdu	Set the maximum PDU.
Qtech(config-mpls-router)# no mpls ldp max-pdu	Restore the default PDU (4096).

Configuring the Extended LDP Discovery Mechanism

The basic discovery mechanism is used to detect the local LDP peers. That is, set up a local LDP session with the directly connected LSR. The extended discovery mechanism is used to detect the remote LDP peers. That is, set up a remote LDP session with the non-directly connected LSR.

Command	Function
Qtech(config-mpls-router)# neighbor ip-address	Create an extended LDP peer.
Qtech(config-mpls-router)# no neighbor ip-address	Delete an extended LDP peer.

1.2.10.2 Configuring LDP Loop Detection

Configuring the Loop Detection Mode

The LDP provides two methods to detect loops: maximum number of hops and path vector. By default, loop detection is disabled for the LDP.

In the loop detection based on the maximum number of hops, in addition to label information, a packet also carries the number of hops and the number increases by one every time the packet

passes an LSR. When the number exceeds a preconfigured maximum value, the device considers that a loop occurs on the LSP.

In the loop detection mode of path vector, the packet also carries the LSR ID apart from the label information. At each hop, an LSR first checks whether the number of LSRs in the path vector list already exceeds the preset maximum number in the path vector list. If yes, it means that a loop occurs. If not, the LSR continues to check whether its LSR ID already exists in the path vector list of the LDP message. If yes, it means that a loop occurs; if not, the LSR adds its own LSR ID to the path vector list.

Command	Function
Qtech(config-mpls-router)# loop-detection	Enable loop detection.
Qtech(config-mpls-router)# no loop-detection	Disable loop detection.

Configuring the Maximum Number of Hops

In the interface mode, you can set the maximum number of hops allowed in the loop detection mode. By default, the number is 254. You can set the value at the range of 1 to 255. If loop detection is enabled and the number of hops in an LDP message is detected to exceed the set value, the LSR considers that a loop occurs.

Command	Function
Qtech(config-if-type ID)# mpls ldp max-hop-count number	Set the maximum number of hops in loop detection.
Qtech(config-if-type ID)# no mpls ldp max-hop-count	Restore the default value of the maximum number of hops in loop detection.

Configuring the Maximum Number in the Path Vector List

In the interface mode, you can set the maximum number of LSRs included in the path list of the loop detection based on path vector. By default, the number is 254. You can set the number at the range of 0 to 254. The number means the maximum number of LSRs that can be carried in the path vector list. After loop detection is enabled, an LSR considers that a loop occurs if the LSR detects its own LSR ID in the path vector list or the number of LSR IDs in the path vector list exceeds the preset value.

Command	Function
Qtech(config-mpls-router)# mpls ldp max-path-vector number	Set the maximum number in the path vector list of loop detection.
Qtech(config-mpls-router)# no mpls ldp max-path-vector	Restore the default value of the maximum number in the path vector list of loop detection.

1.2.10.3 Configuring the LDP Working Mode

Configuring the LDP Label Distribution Control Mode

The LDP label distribution control mode specifies when an LSR notifies its neighbors of the binding between labels and FECs. There are two control modes: independent control and ordered control.

In independent control mode, the LSR announces to its adjacent devices the binding of labels and FECs at any required time. In ordered control mode, an LSR binds an FEC to a label and sends the binding upstream only when the FEC has the next-hop label mapping or the LSR is the egress LSR of the FEC.

By default, the LDP uses the independent control mode. You can run the `lsp-control-mode` command to set the LDP control mode.

Command	Function
Qtech(config-mpls-router)# lsp-control-mode { independent orderd }	Set the label distribution control mode.
Qtech(config-mpls-router)# no lsp-control-mode	Restore the default label distribution control mode.

Configuring the LDP Label Distribution Mode

The LDP label distribution mode specifies how an LSR notifies its neighbors of the binding between labels and FECs. There are two modes: DOD and DU.

In DOD mode, a downstream LSR responds to a label binding message only after the receipt of a label request from an upstream LSR neighbor. In DU mode, one LSR voluntarily sends label binding messages to its upstream LSRs according to certain triggering policies. If the upstream and downstream LSRs use different label distribution modes, use the DU mode if the LSRs are connected to each other through Ethernet.

By default, the LDP works in DU mode. You can use the `distribution-mode` command in the interface mode to set the label distribution mode on an interface.

Command	Function
Qtech(config-if-type ID)# mpls ldp distribution-mode { du dod }	Set the label distribution mode.
Qtech(config-if-type ID)# no mpls ldp distribution-mode	Restore the default label distribution mode (DU).

Configuring the LDP Label Retention Mode

The label retention mode specifies whether an LSR should retain the label binding learnt from a label mapping message if the message is not sent from the next hop of the corresponding FEC or the message does not match any existing IP route. There are two label retention modes: conservative and liberal modes.

When the preceding situation occurs, the liberal mode retains the binding of the FEC and label from the neighbor whereas the conservative mode does not retain the binding information.

The conservative label retention mode uses and maintains a small number of labels. The LSR should re-obtain the label values in the case of route changes, prolonging responses. The liberal label retention mode, however, responds rapidly to route changes but unnecessary label mappings are also distributed and maintained.

By default, the LDP uses the liberal label retention mode.

You can run the `label-retention-mode` command to set the label retention mode.

Command	Function
Qtech(config-mpls-router)# label-retention-mode { liberal conservation }	Set the label retention mode.
Qtech(config-mpls-router)# no label-retention-mode	Restore the default label retention mode.

Configuring the Transmission Mode of Label Release Messages

When an FEC becomes invalid, the LDP sends label release messages to downstream devices to cancel the label bound to the FEC. Each LDP device on the LSR determines whether to transmit the messages to downstream devices based on the setting on the transmission mode of label release messages.

By default, an LDP device does not send label release messages received from an upstream device to downstream devices.

You can run the `propagate-release` command to set the transmission mode of label release messages.

Command	Function
Qtech(config-mpls-router)# propagate-release	Configure a device to send label release messages to downstream devices.
Qtech(config-mpls-router)# no propagate-release	Configure a device not to send label release messages to downstream devices.

1.2.10.4 Configuring Label Control Policies

Configuring Label Distribution Policies

By default, the LDP assigns labels to all valid IGP routes (excluding BGP routes). In some special situations, you may only want to assign labels to some routes or to only certain LDP peers. In this manner, you can reduce the number of labels and the number of LSPs to lessen device and network burdens.

Command	Function
Qtech(config-mpls-router)# advertise-labels for host-routes	Configure the device to assign labels to only host routes that satisfy the mask length of 32 bits in the route forwarding table. By default, the mask length of routes is not restricted.
Qtech(config-mpls-router)# advertise-labels for bgp-routes [acl <i>acl-name</i>]	Configure the device to assign labels to BGP routes. By default, the LDP does not assign labels to BGP routes.
Qtech(config-mpls-router)# advertise-labels for default-route	Configure the device to assign labels to default routes. By default, the LDP assigns implicit null label 3 to default routes.
Qtech(config-mpls-router)# advertise-labels for acl <i>prefix-access-list</i> [to <i>peer-access-list</i>]	Configure the device to assign labels to FECs that match ACL rules and specify the device to assign labels only to LDP peers that match the rules.



Caution By default, the LDP assigns labels to only IGP routes. To assign labels to BGP routes, you can run the **advertise-labels for bgp-routes** command.

By default, the LDP does not set up an LSP for default routes.

Configuring Label Reception Policies

By default, the LDP receives all label binding information sent from all neighbors. In certain situations, you may need to control the device to receive only some binding information about FECs and labels from certain neighbors. In this case, you can run the **neighbor ip-address labels accept** command.

Command	Function
Qtech(config-mpls-router)# neighbor ip-address labels accept acl-name	Configure a label reception policy.

Configuring Policies for Distributing Explicit Null Labels

By default, the LDP assigns implicit null labels to the FEC (such as direct routes) with the local device as the egress. You can use the **explicit-null** command to assign explicit null labels to all direct routes or routes that match certain ACL rules. You can also use the **no explicit-null** command to restore the default setting.

Command	Function
Qtech(config-mpls-router)# explicit-null [for prefix_acl to peer_acl]	Configure a device to assign explicit null labels to all direct routes or routes that match certain ACL rules.
Qtech(config-mpls-router)# no explicit-null	Restore the default setting.



Caution For an FEC with the local device as the egress, the device cannot assign explicit null labels to the FEC if the corresponding LSP is a tunnel that carries L2VPN or L3VPN services.

Configure this function only for the global LDP instance. This function is not supported by the VRF instance.

1.2.10.5 Configuring the LDP MD5 Authentication

To enhance the reliability of LDP sessions, you can configure the MD5 authentication for the TCP connections used by the LDP sessions. You can run the **neighbor ip-address password [0 | 7] pwd-string** command to configure the MD5 authentication for TCP connections between a device and its peer and run the **no neighbor ip-address password [0 | 7] pwd-string** command to restore the default setting.

Command	Function
Qtech(config-mpls-router)# neighbor ip-address password [0 7] pwd-string	Configure a device to adopt the MD5 authentication for the TCP connections with its peer.

Command	Function
Qtech(config-mpls-router)# no neighbor <i>ip-address</i> password	Restore the default setting.

1.2.10.6 Configuring LDP Inter-Area LSP

Default Setting

The following table describes the default setting of LDP inter-area LSP.

Feature	Default
LDP inter-area LSP	This function is disabled.

Creating a Configuration Task

❖ Application Environment

When an AS is grouped into multiple IGP areas and route aggregation is enabled on an ABR, enable LDP inter-area LSP to build a label switch path across multiple IGP areas on all the ABRs running LDP.

❖ Preset Task

Before you enable LDP inter-area LSP, complete the following tasks:

- 1) Configure IGP.
- 2) Configure ABRs to aggregate host routes.
- 3) Configure MPLS LDP sessions.

Configuring LDP Inter-Area LSP

Command	Function
Qtech# configure terminal	Enter the global configuration mode.
Qtech(config)# mpls router ldp	Enter the LDP configuration mode.
Qtech(config-mpls-router)# inter-area-lsp	Enable LDP inter-area LSP on devices between PEs.

Displaying Configuration

Use the following commands to display LDP configuration parameters:

Command	Function
show mpls ldp parameters	Display LDP configuration parameters to check whether LDP inter-area LSP is enabled.
show mpls ldp bindings	Display the FEC-label binding. If LDP inter-area LSP is enabled, the maximum matching route of the FEC added with the LDP entry has an IA identifier.

1.2.10.7 Configuring LDP Session Protection

Default Setting

The following table describes the default setting of LDP session protection.

Feature	Default
LDP session protection	This function is disabled.

Creating a Configuration Task

❖ Application Environment

To protect LDP sessions between directly-connected LSRs, enable LDP session protection on both LSRs.

❖ Preset Task

Before you enable LDP session protection, complete the following tasks:

- 1) Configure IGP.
- 2) Configure MPLS LDP sessions.

Enabling LDP Session Protection

Command	Function
Qtech# configure terminal	Enter the global configuration mode.
Qtech(config)# mpls router ldp	Enter the LDP configuration mode.
Qtech(config-mpls-router)# session protection	Enable LDP session protection.

(Optional) Configuring LDP Session Protection Parameters

Command	Function
Qtech# configure terminal	Enter the global configuration mode.
Qtech(config)# mpls router ldp	Enter the LDP configuration mode.
Qtech(config-mpls-router)# session protection for acl <i>acl_1</i>	Configure protection for only sessions with the LSR ID matching the specified ACL rule of LDP neighbors. By default, no ACL rule is specified, which means all LDP sessions are protected.
Qtech(config-mpls-router)# session protection duration { infinite <i>seconds</i> }	Configure session protection time. The default session protection time is 86400 seconds (24 hours).

Displaying Configuration

Command	Function
show mpls ldp neighbor detail	Display LDP session information about all or specified VRFs to check whether LDP session protection is enabled.
show mpls ldp parameter	Display LDP configuration parameters to check whether LDP session protection is enabled.

1.2.10.8 Verifying the LDP Information

Display LDP attributes.

You can run the **show mpls ldp parameters [all | vrf vrf-name]** command to display information about LDP attributes, including the LSR ID, transport address, loop detection mechanism, label

distribution control mode, label retention mode, the interval and hold time of Hello packets with extended peers, and the interval and hold time of Keepalive packets with extended peers. You can verify the information to confirm whether the configurations are correct. By default, the LDP attributes of the default VRF are displayed. If all is chosen, the LDP attributes of all VRFs are displayed; if vrf-name is specified, the LDP attributes of a specified VRF are displayed.

Command	Function
Qtech# show mpls ldp parameters [all vrf vrf-name]	Display information about LDP attributes.

Display the information about an interface enabled with LDP.

You can use the **show mpls ldp interface** [all | vrf vrf-name | interface interface-name] command to display the LDP status information about interfaces in all or a specified VRF. You can also display the LDP status information about specific interfaces. By default, the LDP status information about the interfaces of the default VRF is displayed. If all is chosen, the LDP status of interfaces in all VRFs is displayed; if vrf-name is specified, the LDP status of interfaces in a specified VRF is displayed; if interface-name is specified, the LDP status of the specified interface is displayed.

Command	Function
Qtech# show mpls ldp interface [all vrf vrf-name interface-name]	Display information about the interface enabled with LDP.

Display the binding between FECs and labels.

You can use the **show mpls ldp binding** [all | vrf vrf-name] | [ip-address/mask | label label] | [remote | local] command to display the binding information between FECs and labels. You can also use this command to display the LDP working status, whether an FEC is properly bound to a label, or the specific label value bound to an FEC. When using this command, you can filter the display information based on the VRF, address prefix, label value, remote binding, or local binding.

Command	Function
Qtech# show mpls ldp bindings [all vrf vrf-name] [ip-address/mask label label] [remote local]	Display the binding between FECs and labels.

Display LDP neighbors.

You can use the **show mpls ldp neighbor** [all | vrf vrf-name] | [detail] command to display the LDP neighbors of all or a specified VRF, including the TCP connection port, LDP status, statistics about packets received and transmitted, the voluntary LDP discovery party of the local and remote LDP devices. The parameter detail displays the detailed information about LDP neighbors.

Command	Function
Qtech# show mpls ldp neighbor [all vrf vrf-name] [detail]	Display information about LDP neighbors.

Display information about discovered LDP neighbors.

You can use the **show mpls ldp discovery** [all | vrf vrf-name] | [detail] command to display the information about the ports where LDP neighbors are discovered and about the neighbors. The parameter detail displays the detailed information about LDP neighbors.

Command	Function
Qtech# show mpls ldp discovery [all vrf <i>vrf-name</i>] [detail]	Display information about discovered LDP neighbors.

Reset the LDP session.

You can use the `clear mpls ldp neighbor` command to reset an LDP session and set up a new session.

Command	Function
Qtech# clear mpls ldp neighbor [all vrf <i>vrf-name</i>] [* <i>ip-address</i>]	Reset an LDP session and set up a new session.

1.2.11 Configuring Static MPLS Forwarding

To support basic MPLS forwarding functions, you can also use static configurations rather than the LDP. To configure basic MPLS forwarding functions in static mode, perform the following configuration procedures:

- ❖ (Mandatory) Enabling MPLS Globally
- ❖ (Mandatory) Enabling MPLS on an Interface
- ❖ (Mandatory) Configuring a Static LSP



Caution

The configuration of a static LSP is independent of LDP. As a result, IPv4 routes are not required. Even if no IPv4 routes exist on the network, the static LSP takes effect, as long as the physical network is reachable.

For the configuration procedures to enable MPLS globally and enable MPLS on an interface, refer to Procedures for Configuring Basic MPLS.

1.2.11.1 Configuring a Static LSP

The configuration of an MPLS network in static mode centers around the static LSP. The other configurations are the same as those of the LDP. To configure a static LSP, perform the following three procedures:

- ❖ Configuring a Static FTN on the Ingress LSR
- ❖ Configuring a Static ILM on the Intermediate LSR.
- ❖ Configuring a Static ILM on the PHP LSR



Note

The label values 16 to 1024 are reserved for static LSPs. When you configure static LSPs, you can choose only these reserved values.

- ✓ On a router, you must use the **ip ref** command on the label forwarding interface to enable MPLS fast forwarding to improve forwarding performance of the router.

1.2.11.2 Configuring a Static FTN on the Ingress LSR

On the ingress LSP, set up an FTN entry for the FEC, that is, bind the FEC to a label.

You can run the `mpls static ftn` command in the global configuration mode to configure a static FTN. The syntax of the command is as follows:

Command	Function
Qtech(config)# mpls static ftn <i>ip-address / mask</i> out-label <i>label nexthop interface nexthop-ip</i>	Add a global FTN.
Qtech(config)# no mpls static ftn <i>ip-address/mask</i>	Delete a global FTN.

For example, to configure a global FTN that binds label 16 to FEC 192.168.1.0/24, supports the next hop of the LSP as 192.168.10.10, and the outgoing interface as GigabitEthernet 2/1, run the following command:

```
Qtech(config)# mpls static ftn 192.168.1.0/24 out label 16 GigabitEthernet 2/1 192.168.10.10
```

To delete the TFN, run the following command. In this case, you are required to only enter the FEC. Other parameters are not required.

```
Qtech(config)# no mpls static ftn 192.168.1.0/24
```

1.2.11.3 Configuring a Static ILM on the Intermediate LSR.

An intermediate LSR should forward labels for incoming labeled packets. In this case, you are required to configure ILM forwarding entries to map incoming labels to outgoing ones. You can run the `mpls static ilm in-label` command in the global configuration mode to configure a static ILM. The syntax of the command is as follows:

Command	Function
Qtech(config)# mpls static ilm in-label <i>in_label</i> forward-action swap-label <i>swap_label nexthop</i> <i>interface nexthop-ip fec ip-address/mask</i>	Add a global ILM.
Qtech(config)# no mpls static ilm in-label <i>in_label</i>	Delete a global ILM.

For example, to configure a global ILM that maps the incoming label 16 to the outgoing label 17, supports the next hop of the LSP as 192.168.11.11, the outgoing interface as GigabitEthernet 2/2, and the FEC of the LSP as 192.168.1.0/24, run the following command:

```
Qtech(config)# mpls static ilm in label 16 forward action swap label 17 nexthop GigabitEthernet 2/2 192.168.11.11 fec 192.168.1.0/24
```

To delete the ILM, run the following command:

```
Qtech(config)# no mpls static ilm in label 16
```

1.2.11.4 Configuring a Static ILM on the PHP LSR

Since the second but last hop should perform PHP, its ILM entries are different from those on other intermediate LSRs. That is, the outgoing label in the ILM of the PHP LSR on the LSP should be an implicit null label (3).



Caution For information about the PHP, refer to related materials.

For example, you are required to configure a global ILM on the PHP LSR of the LSP. The LSR pops out the incoming label 17 and sends the packets from GigabitEthernet 2/2. The next hop address is 192.168.12.12 and the corresponding FEC is 192.168.1.0/24. Run the following command:

```
Qtech(config)# mpls static ilm in label 17 forward action swap label 3 nexthop GigabitEthernet 2/2 192.168.11.11 fec 192.168.1.0/24
```

To delete the ILM, run the following command:

```
Qtech(config)# no mpls static ilm in label 17
```

1.2.11.5 Displaying MPLS Forwarding Table

To display the MPLS forwarding table, you can use the following command in the privileged EXEC mode.

Command	Function
<pre>show mpls forwarding-table [summary [[ip-address/mask label label interface interface-name next-hop ip-address]] [ftn [ip vc] ilm [ip vc]] { vrf vrf-name global } [ftn ilm]] [frr] [detail]]</pre>	<p>Display the MPLS forwarding table.</p> <p>-: displays the whole MPLS forwarding table.</p> <p>summary: displays the statistics information of MPLS process forwarding.</p> <p><i>ip-address/mask</i>:: displays ILM and FTN entries of a specified FEC.</p> <p>label label: displays the ILM entry of a specified label.</p> <p>interface interface-name: displays the MPLS forwarding entry (ILM and FTN) of a specified egress.</p> <p>next-hop ip-address: displays the MPLS forwarding entry (ILM and FTN) of a specified next-hop address.</p> <p>ftn: displays an FEC mapping entry.</p> <p>ilm: displays a label forwarding entry.</p> <p>ip: displays the MPLS forwarding entry of an IP application (including unicast route and L3 VPN).</p> <p>vc: displays the MPLS forwarding entry added by the VC.</p> <p>vrf vrf-name: displays the MPLS forwarding entry related to a VRF.</p> <p>detail: displays the details about the MPLS forwarding entry.</p> <p>global: displays global non-VRF MPLS forwarding entries, excluding FTN and ILM entries of VC.</p>

No parameter is carried, indicating that all MPLS forwarding entries are displayed.

Use the **show mpls forwarding-table** command to show information about all MPLS forwarding entries (including ILM and FTN entries).

Use the **show mpls forwarding-table ip-address/mask** command to display information about specified MPLS forwarding entries (including ILM and FTN entries).

Use the **show mpls forwarding-table label label** command to display the ILM forwarding entries of a specified label.

Use the **show mpls forwarding-table interface interface-name** command to display the MPLS forwarding entries of a specified egress (including FTN and ILM entries).

Use the **show mpls forwarding-table next-hop ip-address** command to display the MPLS forwarding entries of a specified next hop (including FTN and ILM entries).

Use the **show mpls forwarding-table detail** command to display details about all MPLS forwarding entries (including ILM and FTN entries).

Use the **show mpls forwarding-table vrf** command to display all MPLS forwarding entries (including ILM and FTN entries) which belong to a VRF.

Use the **show mpls forwarding-table vrf vrf-name ftm** command to display information about all FTN entries which belong to a VRF.

Use the **show mpls forwarding-table vrf vrf-name ilm** command to display information about all ILM entries which belong to a VRF.

Use the **show mpls forwarding-table ftm ip** command to display FTN entries of unicast routes and L3 VPN application.

Use the **show mpls forwarding-table ilm ip** command to display ILM entries of unicast routes and L3 VPN application.

Use the **show mpls forwarding-table ftm** command to display all FTN entries.

Use the **show mpls forwarding-table ilm** command to display all ILM entries.

Use the **show mpls forwarding-table ftm vc** command to display all FTN entries of L2 VPN.

Use the **show mpls forwarding-table ilm vc** command to display all ILM entries of L2 VPN.

Use the **show mpls forwarding-table ftm detail** command to display details about all FTN entries.

Use the **show mpls forwarding-table ilm detail** command to display details about all ILM entries.

The following example displays all MPLS forwarding entries.

```
Qtech#showmpls forwarding table
Label Operation Code:
PH  PUSH label
PP  POP label
SW  SWAP label
```

```

SP  SWAP topmost label and push new label
DP  DROP packet
PC  POP label and continue lookup by IP or Label
PI  POP label and do ip lookup forward
PN  POP label and forward to nexthop
PM  POP label and do MAC lookup forward
PV  POP label and output to VC attach interface
IP  IP lookup forward
s  stale
   Local  Outgoing OP FEC                Outgoing  Nexthop
labellabel                interface
s      1024  PH 1.1.1.1/32                Gi0/2     50.1.1.1
      imp null PH 1.1.2.2/32            Gi0/2     50.1.1.1

```

The following example displays statistics information of the process forwarding module.

```

Qtech# show mpls forwarding table summary
MPLS forwarding is ON
Enable count:1
ILM entrys:14
ILM changes:14
ILM failed changes :0
IP FTN entrys:0
IP FTN changes:4
IP FTN failed changes:0
L2 FTN entrys:0
L2 FTN changes:0
L2 FTN failed changes:0
In label packets:0
Out label packets:0
Send label packets:0
In ip packets:0
Out ip packets:0
Out ip stack packets:0
Forwarding packets:0
Fragment packets:0
Fragment error packets:0
Label error packets:0
Label failed packets:0
Ttl over packets:0
Buffer failed packets:0
Ip don't fragment packets:0
Other failed packets:0

```

The following example displays FRR information of the process forwarding module.

```

Qtech#show mpls forwarding table frr

```

```

Label Operation Code:
PH  PUSH label
PP  POP label
SW  SWAP label
SP  SWAP topmost label and push new label
DP  DROP packet
PC  POP label and continue lookup by IP or Label
PI  POP label and do ip lookup forward
PN  POP label and forward to nexthop
PM  POP label and do MAC lookup forward
PV  POP label and output to VC attach interface
IP  IP lookup forward

Status codes: m  main entry, b  backup entry, *  active.
Local   Outgoing  OP   FEC                Outgoing  Nexthop
Label   label                    interface
m*      1026      PH   120.1.1.0/24      Gi3/18    10.0.2.1
b       1027      PH   120.1.1.0/24      Gi3/19    10.0.3.1
m* 1028  1029      SW   120.1.2.0/24      Gi3/18    10.0.2.1
b 1028  1030      SW   120.1.2.0/24      Gi3/29

```

1.2.11.6 Displaying MPLS REF Table

To display information about the MPLS REF table, including IPv4 FTN, IPv6 FTN, ILM, next hop and global information, you can use the following commands in the privileged EXEC mode.

Command	Function
<pre>show mpls ref ftn-ipv4 [global vrf vrf_name] [ip_address / mask [detail]]</pre>	<p>Display information about IPv4 FTN of MPLS REF.</p> <p>Global: Display MPLS REF information in the global VRF.</p> <p>vrf vrf-name: Display MPLS REF information in the specified VRF.</p> <p>ip-address / mask: Display information about the specified IPv4 FEC.</p> <p>ipv6-address / mask: Display information about the specified IPv6 FEC.</p> <p>in-label label: Perform filtering according to the in-label, in the range from 16 to 1048575.</p> <p>nhlfe_id: ID of next hop label forwarding entry (NHLFE), in the range from 1 to 4294967295.</p> <p>detail: Display MPLS REF table details</p> <p>summary: Display global information</p>
<pre>show mpls ref ilm [in-label label [detail] summary]</pre>	Display information about ILM of MPLS REF.
<pre>show mpls ref nhlfe [[nhlfe_id [detail]] summary]</pre>	Display information about the next hop of MPLS REF.
<pre>show mpls ref summary</pre>	Display the global information about MPLS REF.

The following example displays information about IPv4 FTN of MPLS REF.

```
Qttech# show mpls ref ftn ipv4
```

VRF	FEC	NHLFE ID	NHLFE Type
0	2.2.2.2/32	32767	single path

VRF means the VRF that the FTN belongs to.

FEC means forwarding equivalence class.

NHLFE ID means ID of the next hop label forwarding entry.

NHLFE TYPE means type of the next hop label forwarding entry, either uni-path or multi-path.

The following example displays information about ILM of MPLS REF.

```
Qttech# show mpls ref ilm
```

In Intf	In Label	Type	Pathnum	Opcode	VRF	VC ID	Out Intf	Nexthop
0	112	single	1	pop	0	0	3	10.1.1.1

In intf means incoming interface value, The label is globe-based label space, so the incoming interface value is 0 constantly.

In label means incoming label.

Pathnum means the number of paths.

Opcode means label operation type.

VRF means VRF value.

VC_ID means that used for L2 VPN forwarding.

Out Intf means outgoing interface ID.

Nexthop means next hop IP address.

The following example displays NHLFE information.

```
Qttech# show mpls ref nhlfe
```

ID	Type	Pathnum	Opcode	Intf	ADJ ID	Nexthop
32767	single	1	push	1	20	172.18.1.2

ID means ID of the next hop label forwarding entry.

TYPE means type of the next hop label forwarding entry, either uni-path or multi-path.

Pathnum means the number of paths.

Opcode means label operation type.

Intf means outgoing interface.

ADJ_ID means adjacent list ID.

Nexthop means next hop IP address.

The following example displays global information about MPLS REF.

```
Qtech# show mpls ref summary
MPLSREF Summary:
ctrl pid: 4294963185
ctrl sn: 0
global enable: false
vpn ttl propagate: true
public ttl propagate: true
# of labels popped before icmp reply: 0
fragment enable: true
loadbalance scheme: per flow
```

ctrl pid means ID of MPLS process.

ctrl sn means serial number of MPLS process.

global enable means whether to enable MPLS forwarding globally.

vpn ttl propagate means whether to enable the TTL propagate function on VPN packets.

public ttl propagate means whether to enable the TTL propagate function globally.

of labels popped before icmp reply means the number of labels popping up before ICMP replies.

loadbalance scheme means load balance scheme.

1.3 Configuration Example

1.3.1 Basic MPLS Function Examples

Figure 7

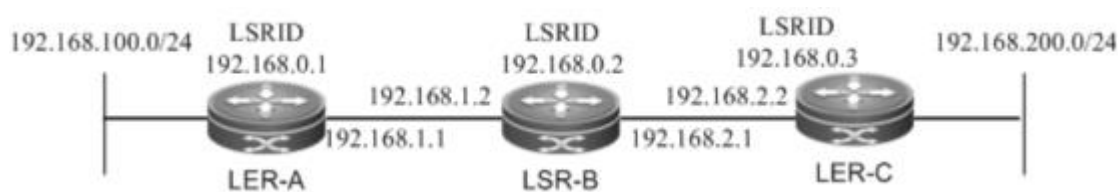

As shown in the preceding figure, three MPLS devices are deployed to construct an MPLS network. The following introduces the setup of an LSP through the LDP and the setup of a static LSP to display the MPLS configuration procedures.

1.3.2 Setting Up an LSP Through LDP

The LDP works only with IPv4 routes. Here, OSPF is enabled to set up IPv4 routes. Before the following configurations, make sure that you have created a loopback interface (Loopback 0) and assigned an IP address, which also serves as the router ID, to the loopback interface on each device.

Configurations on LER_A:

Command	Function
Qtech(config)# mpls ip	Enable MPLS globally.
Qtech(config)# mpls router ldp	Enable LDP and enter the LDP mode.
Qtech(config-mpls-router)# ldp router-id interface loopback 0 force	Configure the LDP router ID. The loopback address is generally used as the router ID.
Qtech (config-mpls-router)# exit	Quit the LDP mode and enter the global configuration mode.
Qtech(config)# interface gigabitEthernet 2/2	Enter the interface mode of GigabitEthernet 2/2.
Qtech(config-if-GigabitEthernet 2/2)# mpls ip	Enable LDP on the interface.
Qtech(config-if-GigabitEthernet 2/2)# label-switching	Enable MPLS on the interface.
Qtech(config-if-GigabitEthernet 2/2)# ip ref	Enable MPLS fast forwarding on the interface of a router.
Qtech(config-if-GigabitEthernet 2/2)# exit	Quit the interface mode and enter the global configuration mode.
Qtech (config)# router ospf 10	Enable OSPF and enter the OSPF mode.
Qtech (config-router)# network 192.168.100.0 0.0.0.255 area 0	Add routing information to OSPF.
Qtech (config-router)# network 192.168.0.1 0.0.0.0 area 0	
Qtech (config-router)# network 192.168.1.0 0.0.0.255 area 0	
Qtech(config-router)# end	End

Configurations on LER_B:

Command	Function
Qtech (config)# mpls ip	Enable MPLS globally.
Qtech (config)# mpls router ldp	Enable LDP and enter the LDP mode.
Qtech(config-mpls-router)# ldp router-id interface loopback 0 force	Configure the LDP router ID. The loopback address is generally used as the router ID.
Qtech (config-mpls-router)# exit	Quit the LDP mode and enter the global configuration mode.
Qtech (config)# interface gigabitEthernet 2/1	Enter the interface mode of GigabitEthernet 2/1.
Qtech(config-if-GigabitEthernet 2/1)# mpls ip	Enable LDP on the interface.
Qtech(config-if-GigabitEthernet 2/1)# label-switching	Enable MPLS on the interface at the public network side.
Qtech(config-if-GigabitEthernet 2/2)# ip ref	Enable MPLS fast forwarding on the interface of a router.
Qtech(config-if-GigabitEthernet 2/1)# exit	Quit the interface mode and enter the global configuration mode.
Qtech (config)# interface gigabitEthernet 2/2	Enter the interface mode of GigabitEthernet 2/2.
Qtech(config-if-GigabitEthernet 2/2)# mpls ip	Enable LDP on the interface.

Qtech(config-if-GigabitEthernet 2/2)# label-switching	Enable MPLS on the interface at the public network side.
Qtech(config-if-GigabitEthernet 2/2)# exit	Quit the interface mode and enter the global configuration mode.
Qtech (config)# router ospf 10	Enable OSPF and enter the OSPF mode.
Qtech (config-router)# network 192.168.1.0 0.0.0.255 area 0 Qtech (config-router)# network 192.168.2 .0 0.0.0.255 area 0 Qtech (config-router)# network 192.168.0.2 0.0.0.0 area 0	Add routing information to OSPF.
Qtech (config-router)# end	End

Configurations on LER_C:

Command	Function
Qtech (config)# mpls ip	Enable MPLS globally.
Qtech (config)# mpls router ldp	Enable LDP and enter the LDP mode.
Qtech(config-mpls-router)# ldp router-id interface loopback 0 force	Configure the LDP router ID. The loopback address is generally used as the router ID.
Qtech (config-mpls-router)# exit	Quit the LDP mode and enter the global configuration mode.
Qtech (config)# interface gigabitEthernet 2/1	Enter the interface mode of GigabitEthernet 2/1.
Qtech(config-if-GigabitEthernet 2/1)# mpls ip	Enable LDP on the interface.
Qtech(config-if-GigabitEthernet 2/1)# label-switching	Enable MPLS on the interface at the public network side.
Qtech(config-if-GigabitEthernet 2/2)# ip ref	Enable MPLS fast forwarding on the interface of a router.
Qtech(config-if-GigabitEthernet 2/1)# exit	Quit the interface mode and enter the global configuration mode.
Qtech (config)# router ospf 10	Enable OSPF and enter the OSPF mode.
Qtech (config-router)# network 192.168.200.0 0.0.0.255 area 0 Qtech (config-router)# network 192.168.0.3 0.0.0.0 area 0 Qtech (config-router)# network 192.168.2.0 0.0.0.255 area 0	Add routing information to OSPF.
Qtech (config-router)# end	End

1.3.3 Configuring a Static LSP

You can configure a static LSP without IPv4 routes.

Consider an example. Set up two LSPs between No.1 interface at the 192.168.100.0/24 network segment on LER_A and No.2 interface at the 192.168.200.0/24 network segment on LER_C to connect the two network segments. You need to configure one LSP from LER_A to LER_C and the other LSP from LER_C to LER_A. This is because the LSP is uni-directional.

- On a router, you must use the **ip ref** command on the label forwarding interface to enable MPLS fast forwarding to improve forwarding performance of the router.

Configurations on LER_A:

Command	Function
Qtech (config)# mpls ip	Enable MPLS globally.
Qtech (config)# interface gigabitEthernet 2/2	Enter the interface mode of GigabitEthernet 2/2.
Qtech(config-if-GigabitEthernet 2/2)# label-switching	Enable MPLS on the interface at the public network side.
Qtech(config-if-GigabitEthernet 2/2)# ip ref	Enable MPLS fast forwarding on the interface of a router.
Qtech(config-if-GigabitEthernet 2/2)# exit	Quit the interface mode and enter the global configuration mode.
Qtech (config)# mpls static ftn 192.168.200.0/24 out-label 16 nexthop gigabitEthernet 2/2 192.168.1.2	Create an FTN that binds 192.168.200.0/24 to label 16, specify the next hop of the FTN as 192.168.1.2 and the outgoing interface as GigabitEthernet 2/2.
Qtech(config-router)# end	End

Configurations on LER_B:

Command	Function
Qtech (config)# mpls ip	Enable MPLS globally.
Qtech (config)# interface gigabitEthernet 2/1	Enter the interface mode of GigabitEthernet 2/1.
Qtech(config-if-GigabitEthernet 2/1)# label-switching	Enable MPLS on the interface at the public network side.
Qtech(config-if-GigabitEthernet 2/1)# ip ref	Enable MPLS fast forwarding on the interface of a router.
Qtech(config-if-GigabitEthernet 2/1)# exit	Quit the interface mode and enter the global configuration mode.
Qtech (config)# interface gigabitEthernet 2/2	Enter the interface mode of GigabitEthernet 2/2.
Qtech(config-if-GigabitEthernet 2/2)# label-switching	Enable MPLS on the interface at the public network side.
Qtech(config-if-GigabitEthernet 2/1)# ip ref	Enable MPLS fast forwarding on the interface of a router.
Qtech(config-if-GigabitEthernet 2/2)# exit	Quit the interface mode and enter the global configuration mode.
Qtech (config)# mpls static ilm in-label 16 forward-action swap-label 3 nexthop gigabitEthernet 2/2 192.168.2.2 fec 192.168.200.0/24	Create an ILM that maps the incoming label 16 to the outgoing label 3 (implicit null label) on GigabitEthernet 2/2. Specify the next hop address as 192.168.2.2 and the FEC as 192.168.200.0/24.
Qtech (config)# mpls static ilm in-label 17 forward-action swap-label 3 nexthop gigabitEthernet 2/1 192.168.1.1 fec 192.168.100.0/24	Create an ILM that maps the incoming label 17 to the outgoing label 3 (implicit null label) on GigabitEthernet 2/1. Specify the next hop address as 192.168.1.1 and the FEC as 192.168.100.0/24.
Qtech (config-router)# end	End

Since LER_B is the PHP LSR for the FEC 192.168.100.0/24, the incoming label 17 is mapped to the outgoing label 3 (implicit null label). The outgoing interface is GigabitEthernet 2/1.

Similarly, since LER_B is the PHP LSR for the FEC 192.168.200.0/24, the incoming label 16 is also mapped to the outgoing label 3 (implicit null label). The outgoing interface is GigabitEthernet 2/2.

Configurations on LER_C:

Command	Function
---------	----------

Qtech (config)# interface gigabitEthernet 2/1	Enter the interface mode of GigabitEthernet 2/1.
Qtech(config-if-GigabitEthernet 2/1)# label-switching	Enable MPLS on the interface at the public network side.
Qtech(config-if-GigabitEthernet 2/1)# ip ref	Enable MPLS fast forwarding on the interface of a router.
Qtech(config-if-GigabitEthernet 2/1)# exit	Quit the interface mode and enter the global configuration mode.
Qtech (config)# mpls static ftn 192.168.100.0/24 out-label 17 nexthop gigabitEthernet 2/1 192.168.2.1	Create an FTN that binds 192.168.200.0/24 to label 16, specify the next hop of the FTN as 192.168.1.2 and the outgoing interface as GigabitEthernet 2/2.
Qtech (config-router)# end	End

After the preceding configurations, the packets destined for the 192.168.200.0/24 network segment on LER_A are sent out by GigabitEthernet 2/2 on LER_A and pushed with label 16. After arrival at the GigabitEthernet 2/1 interface on LER_B, the packets with label 16 are then transformed to IP packets and sent out by GigabitEthernet 2/2 on LER_B. After the IP packets destined for the 192.168.200.0/24 network segment arrives at LER_C, LER_C selects routes based on the destination IP addresses and sends out the packets from GigabitEthernet 2/1.

1.3.4 LDP Inter-Area LSP Configuration Example

The configuration examples are taken on OSPF and ISIS networks.

1.3.4.1 LDP Inter-Area LSP Configuration Example on the OSPF Network

Networking Requirements

The MPLS VPN public network is divided into multiple OSPF areas. Route aggregation advertisement is configured on the ABRs. To build an LSP across multiple OSPF areas between PE1 and PE2, enable LDP inter-area LSP.

Topology

Figure 8 Networking diagram for configuring an LDP inter-area LSP

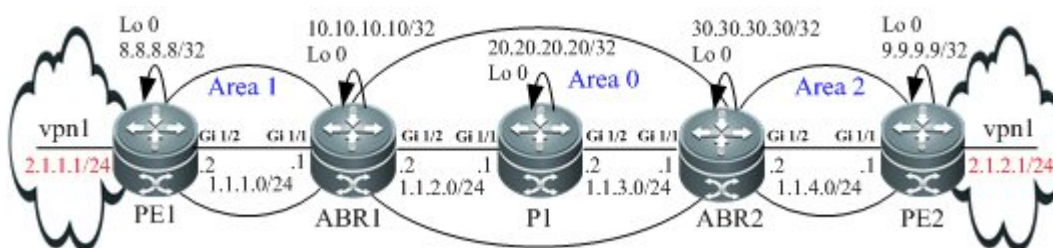

Notes

The configuration points are as follows:

- ❖ Specify IP addresses for the interfaces, configure OSPF, and enable LDP on the interfaces.
- ❖ Configure VPN instances and MP-IBGP neighbors on the PE and configure VPN routing information delivery.
- ❖ Configure aggregation route advertisement on the ABRs.

- ❖ Enable LDP inter-area LSP on each node.

Configuration Steps

Specify IP addresses for the interfaces, configure OSPF, and enable LDP on each node.

Configure PE1:

Configure the loopback interface.

```
Qtech(config)# interface Loopback 0
Qtech(config if Loopback 0)# ip address 8.8.8.8 255.255.255.255
Qtech(config if Loopback 0)# exit
```

Enable MPLS and LDP globally.

```
Qtech(config)# mpls ip
Qtech(config)# mpls router ldp
Qtech(config mpls router)# ldp router id interface Loopback 0 force
Qtech(config mpls router)# exit
```

Specify an IP address for the interface and enable MPLS and LDP on the interface.

```
Qtech(config)# interface gigabitEthernet 1/2
```



Note

On a switch, set the interface to port RoutedPort. This command is unnecessary for a router.

```
Qtech(config if GigabitEthernet 1/2)# no switchport
```

On a router, enable fast forwarding on the interface.

```
Qtech(config if GigabitEthernet 1/2)# ip ref
Qtech(config if GigabitEthernet 1/2)# ip address 1.1.1.2 255.255.255.0
Qtech(config if GigabitEthernet 1/2)# mpls ip
Qtech(config if GigabitEthernet 1/2)# label switching
Qtech(config if GigabitEthernet 1/2)# exit
```

Configure IGP (OSPF).

```
Qtech(config)# router ospf 1
Qtech(config router)# network 1.1.1.0 0.0.0.255 area 1
Qtech(config router)# network 8.8.8.8 0.0.0.0 area 1
Qtech(config router)# exit
```

Configure ABR1:

Configure the loopback interface.

```
Qtech(config)# interface Loopback 0
Qtech(config if Loopback 0)# ip address 10.10.10.10 255.255.255.255
Qtech(config if Loopback 0)# exit
```

Enable MPLS and LDP globally.

```
Qtech(config)# mpls ip
Qtech(config)# mpls router ldp
Qtech(config mpls router)# ldp router id interface Loopback 0 force
Qtech(config mpls router)# exit
```

Specify an IP address for the interface and enable MPLS and LDP on the interface.

```
Qtech(config)# interface gigabitEthernet 1/1
```



Note

On a switch, set the interface to port RoutedPort. This command is unnecessary for a router.

```
Qtech(config if GigabitEthernet 1/1)# no switchport
```



Note

On a router, enable fast forwarding on the interface. This command is unnecessary for a switch.

```
Qtech(config if GigabitEthernet 1/1)# ip ref
Qtech(config if GigabitEthernet 1/1)# ip address 1.1.1.1 255.255.255.0
Qtech(config if GigabitEthernet 1/1)# mpls ip
Qtech(config if GigabitEthernet 1/1)# label switching
Qtech(config if GigabitEthernet 1/1)# exit
Qtech(config)# interface gigabitEthernet 1/2
```



Note

On a switch, set the interface to port RoutedPort. This command is unnecessary for a router.

```
Qtech(config if GigabitEthernet 1/2)# no switchport
```



Note

On a router, enable fast forwarding on the interface. This command is unnecessary for a switch.

```
Qtech(config if GigabitEthernet 1/2)# ip ref
Qtech(config if GigabitEthernet 1/2)# ip address 1.1.2.2 255.255.255.0
Qtech(config if GigabitEthernet 1/2)# mpls ip
Qtech(config if GigabitEthernet 1/2)# label switching
```

```
Qttech(config if GigabitEthernet 1/2)# exit
```

Configure IGP (OSPF).

```
Qttech(config)# router ospf 1
Qttech(config router)# network 1.1.1.0 0.0.0.255 area 0
Qttech(config router)# network 1.1.2.0 0.0.0.255 area 1
Qttech(config router)# network 10.10.10.10 0.0.0.0 area 1
Qttech(config router)# exit
```

Configure P1:

Configure the loopback interface.

```
Qttech(config)# interface Loopback 0
Qttech(config if Loopback 0)# ip address 20.20.20.20 255.255.255.255
Qttech(config if Loopback 0)# exit
```

Enable MPLS and LDP globally.

```
Qttech(config)# mpls ip
Qttech(config)# mpls router ldp
Qttech(config mpls router)# ldp router id interface Loopback 0 force
Qttech(config mpls router)# exit
```

Specify an IP address for the interface and enable MPLS and LDP on the interface.

```
Qttech(config)# interface gigabitEthernet 1/1
```



Note

On a switch, set the interface to port RoutedPort. This command is unnecessary for a router.

```
Qttech(config if GigabitEthernet 1/1)# no switchport
```



Note

On a router, enable fast forwarding on the interface. This command is unnecessary for a switch.

```
Qttech(config if GigabitEthernet 1/1)# ip ref
Qttech(config if GigabitEthernet 1/1)# ip address 1.1.2.1 255.255.255.0
Qttech(config if GigabitEthernet 1/1)# mpls ip
Qttech(config if GigabitEthernet 1/1)# label switching
Qttech(config if GigabitEthernet 1/1)# exit
Qttech(config)# interface gigabitEthernet 1/2
```

**Note**

On a switch, set the interface to port RoutedPort. This command is unnecessary for a router.

```
Qtch(config-if-GigabitEthernet 1/2)# no switchport
```

**Note**

On a router, enable fast forwarding on the interface. This command is unnecessary for a switch.

```
Qtch(config-if-GigabitEthernet 1/2)# ip ref
Qtch(config-if-GigabitEthernet 1/2)# ip address 1.1.3.2 255.255.255.0
Qtch(config-if-GigabitEthernet 1/2)# mpls ip
Qtch(config-if-GigabitEthernet 1/2)# label-switching
Qtch(config-if-GigabitEthernet 1/2)# exit
```

Configure IGP (OSPF).

```
Qtch(config)# router ospf 1
Qtch(config-router)# network 1.1.2.0 0.0.0.255 area 0
Qtch(config-router)# network 1.1.3.0 0.0.0.255 area 0
Qtch(config-router)# network 20.20.20.20 0.0.0.0 area 0
Qtch(config-router)# exit
```

The configuration on ABR2 is the same as that on ABR1 and the configuration on PE2 nodes is the same as that on PE1 nodes. (Details not shown)

Configure VPN instances and MP-IBGP neighbors on the PE and configure VPN routing information delivery.

Configure VRF on PE1. The configuration on PE2 is similar and is not shown.

```
Qtch(config)# ip vrf vpn1
Qtch(config-vrf)# rd 65001:20
Qtch(config-vrf)# route-target both 65001:20
Qtch(config-vrf)# exit
Qtch(config)# interface gigabitEthernet 1/1
```

**Note**

On a switch, set the interface to port RoutedPort. This command is unnecessary for a router.

```
Qtch(config-if-GigabitEthernet 1/1)# no switchport
```



Note

On a router, enable fast forwarding on the interface. This command is unnecessary for a switch.

```
Qtech(config-if-GigabitEthernet 1/1)# ip ref
Qtech(config-if-GigabitEthernet 1/1)# ip vrf forwarding vpn1
Qtech(config-if-GigabitEthernet 1/1)# ip address 2.1.1.1 255.255.255.0
```

Configure MP-IBGP neighbors and configure VPN routing information delivery on PE1. The configuration on PE2 is similar.

```
Qtech(config)# router bgp 65001
Qtech(config-router)# neighbor 9.9.9.9 remote-as 65001
Qtech(config-router)# neighbor 9.9.9.9 update-source Loopback 0
Qtech(config-router)# address-family vpnv4
Qtech(config-router-af)# neighbor 9.9.9.9 activate
Qtech(config-router-af)# neighbor 9.9.9.9 send-community both
Qtech(config-router-af)# exit
Qtech(config-router)# address-family ipv4 vrf vpn1
Qtech(config-router-af)# redistribute connected
Qtech(config-router-af)# exit
Qtech(config-router)# exit
```

Configure aggregation route advertisement on ABR1 and ABR2.

Configure ABR1:

```
Qtech# configure terminal
Enter configuration commands, one per line. End with CNTL/Z.
Qtech(config)# router ospf 1
Qtech(config-router)# area 1 range 8.0.0.0 255.0.0.0
Qtech(config-router)# exit
```

The configuration of ABR1 is the same as that of ABR2. (Details not shown)

Enable LDP inter-area LSP on each node on PE1. Configuration on other nodes is similar.

Enable LDP inter-area LSP on PE1.

```
Qtech# configure terminal
Enter configuration commands, one per line. End with CNTL/Z.
Qtech(config)# mpls router ldp
Qtech(config-router)# inter-area-lsp
Qtech(config-router)# exit
```

Verification

Check whether LDP inter-area LSP is enabled on the PE1 and PE2:

Check whether LDP inter-area LSP is enabled.

```
Qtech# show mpls ldp parameters
```

```
Default VRF:
```

```
Protocol version: 1
Ldp Router ID: 8.8.8.8
Control Mode: INDEPENDENT
Propagate Release: FALSE
Label Merge: TRUE
Label Retention Mode: LIBERAL
```

```
Loop Detection Mode: off
```

```
Inter Area Lsp: TRUE
```

```
Session Protection: FALSE
```

```
Targeted Session Keepalive HoldTime/Interval: 180/60 sec
```

```
Targeted Hello HoldTime/Interval: 90/10 sec
```

Check whether LDP inter-area LSP is enabled and display the added LDP entry of the maximum matching route.

Display the added LDP entry of the maximum matching route.

```
Qttech# show mpls ldp bindings
```

```
Default VRF:
```

```
lib entry: 10.10.10.10/32
```

```
local binding: to lsr: 10.10.10.10:0, label: 1027
```

```
local binding: to lsr: 30.30.30.30:0, label: 1027
```

```
remote binding: from lsr: 10.10.10.10:0, label: imp null
```

```
remote binding: from lsr: 30.30.30.30:0, label: 1030 (not in FIB)
```

```
lib entry: 9.9.9.9/32, (IA)
```

```
local binding: to lsr: 10.10.10.10:0, label: 1028
```

```
local binding: to lsr: 30.30.30.30:0, label: 1028
```

```
remote binding: from lsr: 10.20.10.10:0, label: 1027 (not in FIB)
```

```
remote binding: from lsr: 30.30.30.30:0, label: 1031
```

1.3.4.2 LDP Inter-Area LSP Configuration Example on the ISIS Network

Networking Requirements

The MPLS VPN public network is divided into multiple ISIS areas. Route aggregation advertisement is configured on the ABRs. To build an LSP across multiple ISIS areas between PE1 and PE2, enable LDP inter-area LSP.

Topology

Figure 9 Networking diagram for configuring LDP inter-area LSP

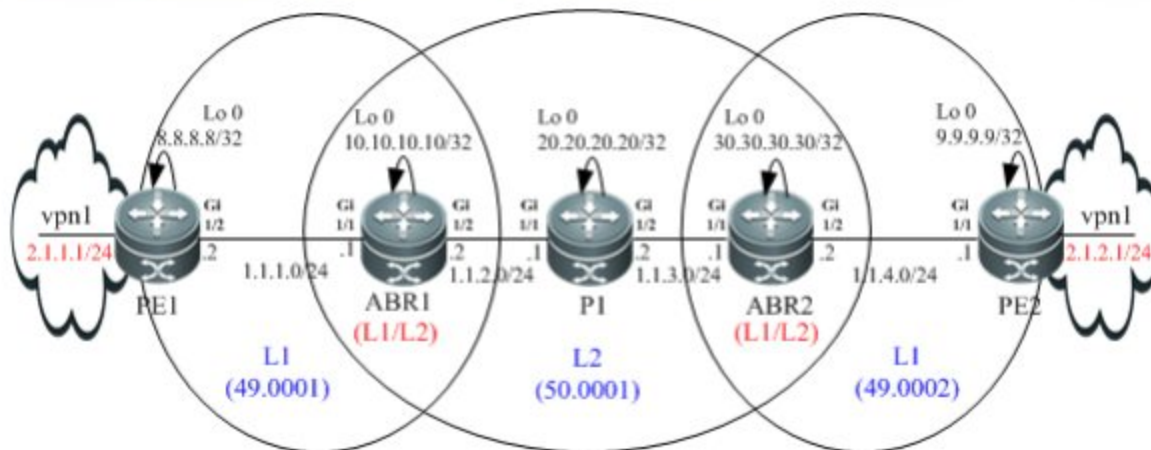

Notes

The configuration points are as follows:

- ❖ Specify IP addresses for the interfaces and configure ISIS on each node.
- ❖ Configure VPN instances and MP-IBGP neighbors on the PE and configure VPN routing information delivery.
- ❖ Configure aggregation route advertisement on the ABRs.
- ❖ Enable LDP inter-area LSP on each node.

Configuration Steps

Configure ISIS on each node, specify an IP address for each interface, and enable ISIS on each interface.

Configure P1:

Configure ISIS.

```
Qtech(config)# router isis
Qtech(config-router)# net 50.0001.0000.0000.0001.00
Qtech(config-router)# is-type level-2-only
Qtech(config-router)# exit
```

Configure the loopback interface and enable ISIS on the interface.

```
Qtech(config)# interface Loopback 0
Qtech(config-if-Loopback 0)# ip address 20.20.20.20 255.255.255.255
Qtech(config-if-Loopback 0)# ip router isis
Qtech(config-if-Loopback 0)# exit
```

Enable MPLS and LDP globally.

```
Qtech(config)# mpls ip
Qtech(config)# mpls router ldp
Qtech(config-mpls-router)# ldp router-id interface Loopback 0 force
Qtech(config-mpls-router)# exit
```

Specify an IP address for the interface and enable MPLS, LDP, and ISIS on the interface.

```
Qtech(config)# interface gigabitEthernet 1/1
```



Note

On a switch, set the interface to port RoutedPort. This command is unnecessary for a router.

```
Qtech(config if GigabitEthernet 1/1)# no switchport
```



Note

On a router, enable fast forwarding on the interface. This command is unnecessary for a switch.

```
Qtech(config if GigabitEthernet 1/1)# ip ref
Qtech(config if GigabitEthernet 1/1)# ip address 1.1.2.1 255.255.255.0
Qtech(config if GigabitEthernet 1/1)# mpls ip
Qtech(config if GigabitEthernet 1/1)# label switching
Qtech(config if GigabitEthernet 1/1)# ip router isis
Qtech(config if GigabitEthernet 1/1)# exit
Qtech(config)# interface gigabitEthernet 1/2
Qtech(config if GigabitEthernet 1/2)# no switchport
Qtech(config if GigabitEthernet 1/2)# ip address 1.1.3.2 255.255.255.0
Qtech(config if GigabitEthernet 1/2)# mpls ip
Qtech(config if GigabitEthernet 1/2)# label switching
Qtech(config if GigabitEthernet 1/2)# ip router isis
Qtech(config if GigabitEthernet 1/2)# exit
```

Configure ABR1:

Configure ISIS.

```
Qtech(config)# router isis
Qtech(config router)# net 49.0001.0000.0000.0002.00
Qtech(config router)# is type level 1 2
Qtech(config router)# exit
```

Configure the loopback interface and enable ISIS on the interface.

```
Qtech(config)# interface Loopback 0
Qtech(config if Loopback 0)# ip address 10.10.10.10 255.255.255.255
Qtech(config if Loopback 0)# ip router isis
Qtech(config if Loopback 0)# exit
```

Enable MPLS and LDP globally.

```
Qtech(config)# mpls ip
Qtech(config)# mpls router ldp
Qtech(config mpls router)# ldp router id interface Loopback 0 force
Qtech(config mpls router)# exit
```

Specify an IP address for the interface and enable MPLS, LDP, and ISIS on the interface.

```
Qtech(config)# interface gigabitEthernet 1/1
```



Note

On a switch, set the interface to port RoutedPort. This command is unnecessary for a router.

```
Qtech(config if GigabitEthernet 1/1)# no switchport
```



Note

On a router, enable fast forwarding on the interface. This command is unnecessary for a switch.

```
Qtech(config if GigabitEthernet 1/1)# ip ref
Qtech(config if GigabitEthernet 1/1)# ip address 1.1.1.1 255.255.255.0
Qtech(config if GigabitEthernet 1/1)# mpls ip
Qtech(config if GigabitEthernet 1/1)# label switching
Qtech(config if GigabitEthernet 1/1)# ip router isis
Qtech(config if GigabitEthernet 1/1)# exit
Qtech(config)# interface gigabitEthernet 1/2
```



Note

On a switch, set the interface to port RoutedPort. This command is unnecessary for a router.

```
Qtech(config if GigabitEthernet 1/2)# no switchport
```



Note

On a router, enable fast forwarding on the interface. This command is unnecessary for a switch.

```
Qtech(config if GigabitEthernet 1/2)# ip ref
Qtech(config if GigabitEthernet 1/2)# ip address 1.1.2.2 255.255.255.0
Qtech(config if GigabitEthernet 1/2)# mpls ip
```

```
Qtech(config if GigabitEthernet 1/2)# label switching
Qtech(config if GigabitEthernet 1/2)# ip router isis
Qtech(config if GigabitEthernet 1/2)# exit
```

Configure PE1:

Configure ISIS.

```
Qtech(config)# router isis
Qtech(config router)# net 49.0001.0000.0000.0003.00
Qtech(config router)# is type level 1
Qtech(config router)# exit
```

Configure the loopback interface and enable ISIS on the interface.

```
Qtech(config)# interface Loopback 0
Qtech(config if Loopback 0)# ip address 8.8.8.8 255.255.255.255
Qtech(config if Loopback 0)# ip router isis
Qtech(config if Loopback 0)# exit
```

Enable MPLS and LDP globally.

```
Qtech(config)# mpls ip
Qtech(config)# mpls router ldp
Qtech(config mpls router)# ldp router id interface Loopback 0 force
Qtech(config mpls router)# exit
```

Specify an IP address for the interface and enable MPLS, LDP, and ISIS on the interface.

```
Qtech(config)# interface gigabitEthernet 1/2
```



Note

On a switch, set the interface to port RoutedPort. This command is unnecessary for a router.

```
Qtech(config if GigabitEthernet 1/2)# no switchport
```



Note

On a router, enable fast forwarding on the interface. This command is unnecessary for a switch.

```
Qtech(config if GigabitEthernet 1/2)# ip ref
Qtech(config if GigabitEthernet 1/2)# ip address 1.1.1.2 255.255.255.0
Qtech(config if GigabitEthernet 1/2)# mpls ip
Qtech(config if GigabitEthernet 1/2)# label switching
Qtech(config if GigabitEthernet 1/2)# ip router isis
Qtech(config if GigabitEthernet 1/2)# exit
```

The configuration on ABR2 is the same as that on ABR1 and the configuration on PE2 nodes is the same as that on PE1 nodes. (Details not shown)

Configure VPN instances and MP-IBGP neighbors on the PE and configure VPN routing information delivery.

Configure VRF on PE1. The configuration on PE2 is similar and is not shown.

```
Qtech(config)# ip vrf vpn1
Qtech(config vrf)# rd 65001:20
Qtech(config vrf)# route target both 65001:20
Qtech(config vrf)# exit
Qtech(config)# interface gigabitEthernet 1/1
```



Note

On a switch, set the interface to port RoutedPort. This command is unnecessary for a router.

```
Qtech(config if GigabitEthernet 1/1)# no switchport
```



Note

On a router, enable fast forwarding on the interface. This command is unnecessary for a switch.

```
Qtech(config if GigabitEthernet 1/1)# ip ref
Qtech(config if GigabitEthernet 1/1)# ip vrf forwarding vpn1
Qtech(config if GigabitEthernet 1/1)# ip address 2.1.1.1 255.255.255.0
```

Configure MP-IBGP neighbors and configure VPN routes instances on PE1. The configuration on PE2 is similar.

```
Qtech(config)# router bgp 65001
Qtech(config router)# neighbor 9.9.9.9 remote as 65001
Qtech(config router)# neighbor 9.9.9.9 update source Loopback 0
Qtech(config router)# address family vpnv4
Qtech(config router af)# neighbor 9.9.9.9 activate
Qtech(config router af)# neighbor 9.9.9.9 send community both
Qtech(config router af)# exit
Qtech(config router)# address family ipv4 vrf vpn1
Qtech(config router af)# redistribute connected
Qtech(config router af)# exit
Qtech(config router)# exit
```

Configure aggregation route advertisement on ABR1 and ABR2.

Configure ABR1:

```
Qtech# configure terminal
```



```
Enter configuration commands, one per line. End with CNTL/Z.
```

```
Qtech(config)# router isis
Qtech(config router)# summary address 8.0.0.0 255.0.0.0
Qtech(config router)# exit
```

The configuration of ABR1 is the same as that of ABR2. (Details not shown)

Enable LDP intra-area LSP on each node on PE1. Configuration on other nodes is similar.

Enable LDP intra-area LSP on PE1.

```
Qtech# configure terminal
Enter configuration commands, one per line. End with CNTL/Z.
Qtech(config)# mpls router ldp
Qtech(config router)# inter area lsp
Qtech(config router)# exit
```

Verification

Check whether LDP inter-area LSP is enabled on PE1 and PE2:

Check whether LDP inter-area LSP is enabled.

```
Qtech# show mpls ldp parameters
Default VRF:
  Protocol version: 1
  Ldp Router ID: 8.8.8.8
  Control Mode: INDEPENDENT
  Propagate Release: FALSE
  Label Merge: TRUE
  Label Retention Mode: LIBERAL
  Loop Detection Mode: off
  Inter Area Lsp: TRUE
  Session Protection: FALSE
  Targeted Session Keepalive HoldTime/Interval: 180/60 sec
  Targeted Hello HoldTime/Interval: 90/10 sec
```

Check whether LDP inter-area LSP is enabled and display the added LDP entry of the maximum matching route.

Display the added LDP entry of the maximum matching route.

```
Qtech# show mpls ldp bindings
Default VRF:
  lib entry: 10.10.10.10/32
    local binding: to lsr: 10.10.10.10:0, label: 1027
    local binding: to lsr: 30.30.30.30:0, label: 1027
    remote binding: from lsr: 10.10.10.10:0, label: imp null
    remote binding: from lsr: 30.30.30.30:0, label: 1030 (not in FIB)
  lib entry: 9.9.9.9/32, (IA)
    local binding: to lsr: 10.10.10.10:0, label: 1028
```

```
local binding: to lsr: 30.30.30.30:0, label: 1028
remote binding: from lsr: 10.20.10.10:0, label: 1027 (not in FIB)
remote binding: from lsr: 30.30.30.30:0, label: 1031
```

1.3.5 LDP Session Protection Configuration Example

Networking Requirements

To protect LDP sessions between directly-connected LSRs, enable LDP session protection on both LSRs.

Topology

Figure 1-10 Networking diagram for configuring LDP session protection

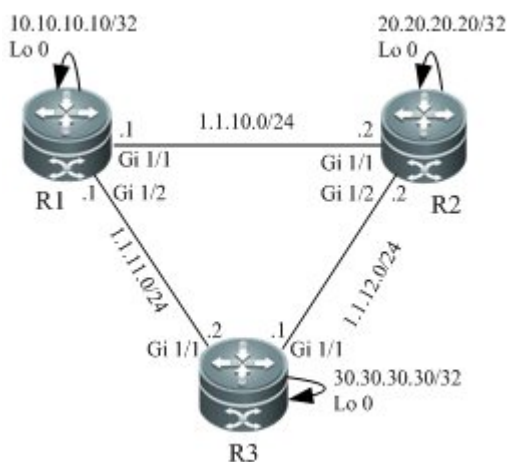

Notes

The configuration points are as follows:

- ❖ Specify IP addresses for the interfaces, configure OSPF, and enable LDP on each node.
- ❖ Enable LDP session protection on nodes as needed.

Configuration Steps

Specify IP addresses for the interfaces, configure OSPF, and enable LDP on the interfaces.

Configure R1. The configuration on R2 and R3 is similar.

Configure the loopback interface.

```
Qtech(config)# interface Loopback 0
Qtech(config-if Loopback 0)# ip address 10.10.10.10 255.255.255.255
Qtech(config-if Loopback 0)# exit
```

Enable MPLS and LDP globally.

```
Qtech(config)# mpls ip
Qtech(config)# mpls router ldp
Qtech(config-mpls-router)# ldp router id interface Loopback 0 force
```

```
Qtech(config mpls router)# exit
```

Specify an IP address for the interface and enable MPLS and LDP on the interface.

```
Qtech(config)# interface gigabitEthernet 1/1
```



Note

On a switch, set the interface to port RoutedPort. This command is unnecessary for a router.

```
Qtech(config if GigabitEthernet 1/1)# no switchport
```



Note

On a router, enable fast forwarding on the interface. This command is unnecessary for a switch.

```
Qtech(config if GigabitEthernet 1/1)# ip ref
Qtech(config if GigabitEthernet 1/1)# ip address 1.1.10.1 255.255.255.0
Qtech(config if GigabitEthernet 1/1)# mpls ip
Qtech(config if GigabitEthernet 1/1)# label switching
Qtech(config if GigabitEthernet 1/1)# exit
Qtech(config)# interface gigabitEthernet 1/2
```



Note

On a switch, set the interface to port RoutedPort. This command is unnecessary for a router.

```
Qtech(config if GigabitEthernet 1/2)# no switchport
```



Note

On a router, enable fast forwarding on the interface. This command is unnecessary for a switch.

```
Qtech(config if GigabitEthernet 1/2)# ip ref
Qtech(config if GigabitEthernet 1/2)# ip address 1.1.11.1 255.255.255.0
Qtech(config if GigabitEthernet 1/2)# mpls ip
Qtech(config if GigabitEthernet 1/2)# label switching
Qtech(config if GigabitEthernet 1/2)# exit
```

Configure IGP (OSPF).

```
Qttech(config)# router ospf 1
Qttech(config router)# network 1.1.10.0 0.0.0.255 area 0
Qttech(config router)# network 1.1.11.0 0.0.0.255 area 0
Qttech(config router)# network 10.10.10.10 0.0.0.0 area 0
Qttech(config router)# exit
```

3) Enable LDP session protection on R1 and R2.

Configure R1. The configuration on R2 is similar.

```
Qttech# configure terminal
Enter configuration commands, one per line. End with CNTL/Z.
Qttech(config)# mpls router ldp
Qttech(config router)# session protection
Qttech(config router)# session protection duration 300
Qttech(config router)# exit
```

Verification

Check whether LDP session protection is enabled on R1 and R2:

Check whether LDP session protection is enabled:

```
Qttech# show mpls ldp parameters
Default VRF:
  Protocol version: 1
  Ldp Router ID: 8.8.8.8
  Control Mode: INDEPENDENT
  Propagate Release: FALSE
  Label Merge: TRUE
  Label Retention Mode: LIBERAL
  Loop Detection Mode: off
  Inter Area Lsp: TRUE
  Session Protection: TRUE
  Targeted Session Keepalive HoldTime/Interval: 180/60 sec
  Targeted Hello HoldTime/Interval: 90/10 sec
```

Check whether LDP session protection is valid:

Check whether LDP session protection is valid:

```
Qttech# show mpls ldp neighbor detail
Default VRF:
  Peer LDP Ident: 20.20.20.20:0; Local LDP Ident: 10.10.10.10:0
  TCP connection: 20.20.20.20.1030 10.10.10.10.646
  State: OPERATIONAL; Msgs sent/recvd: 6/7; UNSOLICITED
  Up time: 00:00:15
  Graceful Restart disabled
  LDP discovery sources:
  Targeted Hello 10.10.10.10 > 20.20.20.20, active, passive;
```

```
Hold time: 45 sec, hello interval: 5 sec
Addresses bound to peer LDP Ident:
1.1.10.2      1.1.20.2      20.20.20.20
Our is PASSIVE
KA hold time: 45 sec; Proposed local/peer: 45/45 sec
Peer distribute label mode: UNSOLICITED
Peer loop detection: Disabled
Peer Path Vector Limit: 0; Max PDU Length: 4096
LDP Session Protection enabled, state: Protecting
duration: 300 seconds
holdup time remaining: 60 seconds
```

2. CONFIGURING L2VPN

2.1 Overview

Similar to an MPLS/VPN BGP L3VPN, an L2VPN also uses the existing public network to extend the private network of a user. For an MPLS L2VPN, Layer 2 user data (such as ATM cells, FR frames, and Ethernet frames) are transparently transmitted on an MPLS network. As far as the user is concerned, the MPLS network is a Layer 2 switching network. The different sites set up Layer 2 connections on the MPLS network.

Compared with L3VPN, the advantages of L2VPN are as follows:

- ❖ Supports various link layer protocols. On an MPLS network, you can provide Layer 2 VPN services based on different medium, including ATM, FR, VLAN, Ethernet, PPP, and HDLC. L2VPN also supports multiple network layer protocols, including IP, IPv6, IPX, and SNA.
- ❖ A PE does not store the information about user VPNs, reducing the overhead on the PE. This largely lessens the burden of PEs and the entire SP network and allows the carriers to support more VPNs and access more users.
- ❖ Allows a user to control the advertising of VPN routes and frees the PE from managing VPN routes. The reliability and confidentiality of user routes are guaranteed.

At present, the service models of an MPLS L2VPN take up the following two forms:

- ❖ Virtual Private Wire Service (VPWS)

You can set up a Pseudo Wire (PW), also called Virtual Circuit (VC), on an IP/MPLS network to simulate Layer 2 point-to-point services, including Ethernet, PPP, HDLC, AAL5 frames, ATM cells, FR, and SONET / SDH. For a user, the VPWS resembles a physical line provided for the user on the carrier's network.

- ❖ Virtual Private LAN Service (VPLS)

Simulate LAN services on an IP/MPLS network to implement Ethernet connections on the WAN. For a user, the user Layer 2 devices are connected to each other across the IP/MPLS core network and the core network is like a virtual switch.

Frame Format of an MPLS L2VPN Packet

As shown in the following figure, an MPLS L2VPN packet is generally encapsulated in two layers of labels. The outer layer is a public label that is responsible for forwarding the packet on the public network. The inner layer is the VC label that is used to identify a VC instance on a PE.

Figure 1-1

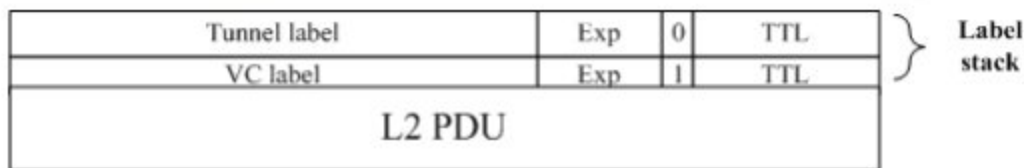

2.1.1 Basic Concepts

The following figure shows the components of an L2VPN.

Figure 1-2

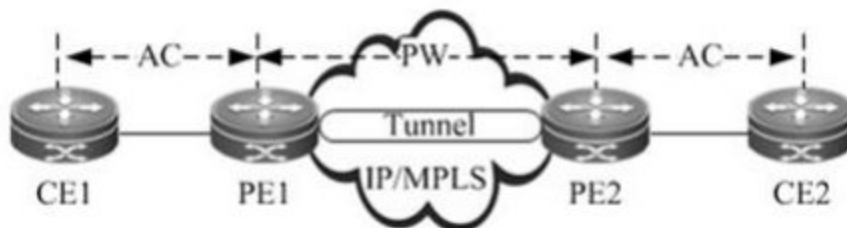

2.1.1.1 CE

A CE is a user device directly connected to the service provider.

2.1.1.2 PE

A PE is an edge device on the SP network connected to CEs. It is responsible for the access of VPN services. The PE forwards packets from a private network to a public tunnel and from the public tunnel to the private network.

In a hierarchical VPLS network, PEs are classified into User Facing Provider Edge devices (U-PEs) and Network Facing Provider Edge devices (N-PEs).

❖ U-PE

A U-PE is a PE next to the user side as the hierarchical VPLS network. It is an aggregation device for users to access a VPN.

❖ N-PE

An N-PE is a core PE device in the hierarchical VPLS network. It is located at the edge of core VPLS domains to provide transparent transmission of VPLS services between core networks.

2.1.1.3 Attachment Circuits

In an L2VPN of any type (VPWS/VPLS), CEs should be connected to PEs through actual physical lines or virtual lines. These physical or virtual lines are referred to as the ACs. For example, an AC can be an Ethernet cable, a VLAN, or an MPLS LSP. All user packets on the AC are generally forwarded to the peer CE without any changes.

2.1.1.4 PW (Pseudo Wire)

A PW is responsible for setting up and maintain the signaling protocol between PEs. The AC transmits frames from a CE to a PE and the PW sends the user frames from one PE to another PE.

In a hierarchical VPLS network, PWs are classified into Hub PWs and Spoke PWs.

❖ Hub PW

A Hub PW indicates a PW set up between N-PEs.

❖ Spoke PW

A Spoke PW indicates a PW set up between a U-PE and N-PE, or a PW with which a user accesses the PE on a basic VPLS network.

2.1.1.5 Forwarder

On an L2VPN, every frame received by a PE from the AC should be forwarded to the corresponding PW. Similarly, the frames received by the PE from the AC are sent to the corresponding AC. This process in forwarding decision-making is called the forwarder.

In VPWS, the forwarder performs the one-to-one mapping for ACs and PWs.

In VPLS, the forwarder is also called the Virtual Switch Instance (VSI) or Virtual Forwarding Instance (VFI), which is the VPLS forwarding table. Through VFI, you can map the ACs of actual VPLS users to PWs.

2.1.1.6 Tunnel

The traffic of PWs between PEs is transmitted over the tunnel. One tunnel can carry multiple PWs. The tunnels mentioned in this chapter always refer to MPLS LSPs.

2.1.1.7 Encapsulation

The L2VPN payload is transmitted over PWs. The PWE3 defines the encapsulation formats and technologies of various packets transmitted over PWs. The PW supports two encapsulation modes: raw and tag. In the raw mode, the service distinguishers are removed from the PDUs transmitted on PWs. In the tag mode, the service distinguishers are included in the PDUs transmitted on PWs. For Ethernet emulated services, the service distinguisher is generally a VLAN tag.

2.1.1.8 PW Signaling

The PW signaling protocol is responsible for creating and maintaining PWs. The PW signaling includes LDP and BGP.

❖ When using LDP sessions to set up PWs

When using LDP sessions to set up PWs, you should set up two types of LDP sessions: LDP sessions set up through the basic discovery mechanism and the extended discovery mechanism. The

former is used to set up public LSPs and the latter to transmit the label mapping messages of PWs. The setup and disconnection of a PW are as follows:

- ❖ Exchange Hello packets between PEs through the target LDP session (through the extended LDP discovery mechanism) and set up the LDP session.
- ❖ When the status of the AC at one PE end is Up, the PE assigns a label to the corresponding PW.
- ❖ The PE encodes the label value and the PW ID to the FEC TLV and sends a label mapping message to the peer PE through the target LDP session.
- ❖ Upon receipt of the label mapping message, the peer PE decodes the PW ID and label value and checks whether the interface parameters (such as MTU) and PW types are consistent.
- ❖ The PW is set up after both ends exchange their label values and verify the validity of PW IDs and interface parameters.
- ❖ To disconnect a PW, send a label withdrawal message to the peer and then disconnect the PW.



Note

Note the following conditions when you set up a PW through LDP; otherwise, the PW cannot be set up:

- 1) The MTUs and PW types on the devices at both ends of the PW must be consistent.
- 2) The PW IDs on the devices at both ends of the PW must be consistent.

❖ Using BGP signaling to set up PWs

Unlike using LDP signaling, this method does not need to configure the connection between CEs in a static manner. Instead, the entire carrier network is divided into different VPNs and CEs are numbered globally in VPN sites. Similar with BGP/MPLS L3 VPN, BGP signaling uses VPN Target to identify CE sites that belong to the same VPN. The process of discovering VPN sites by VPN Target is called the automatic discovery. If BGP is used as the signaling protocol, there will be two stages. The first stage is automatic discovery and the second stage is to set up bidirectional PWs between PEs according to the result of the automatic discovery.

The method of establishing PWs by using the BGP signaling protocol has brought in a concept of the label blocks. It uses the label block to allocate labels for multiple links at a time. Users can specify the site range for a local CE, indicating the number of remote CEs that can be connected with the CE. The system allocates one label block to the CE at a time. The label block's size is equal to the site range. In this way, users can allocate extra labels for VPN. In a short term, this may cause waste of the label resource, but can reduce configuration tasks when VPN is expanded.

Given the BGP protocol's characteristics, such as the route reflector's characteristics, the method of setting up PWs can reduce the full inter-connection of BGP sessions, thus facilitating the expansion of capacity.

2.1.2 Basic Forwarding Process

An L2VPN adopts the two-layer label stack to transmit services on the backbone network. The outer label is used to forward packets on the backbone network and the inner VC label is used to identify a VC instance on PEs. Based on the inner VC label, a PE determines the CE to which the packets should be sent. The following figure shows the forwarding process:

Figure 1-3

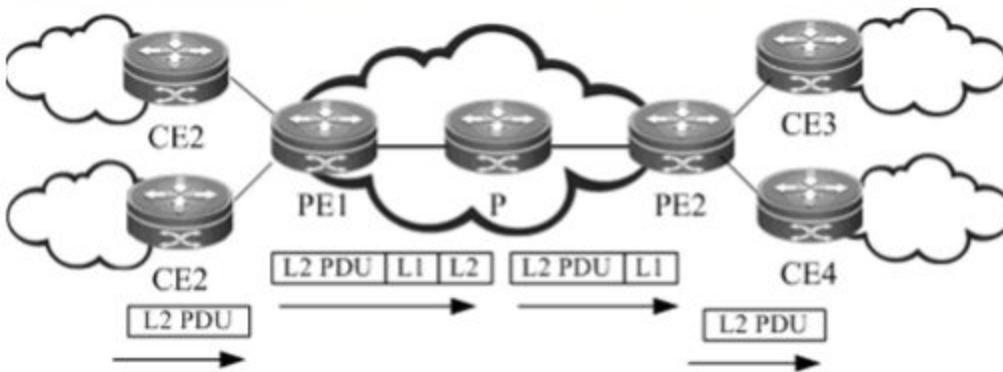

When PE1 receives a Layer 2 packet from CE2, PE1 searches the PW forwarding entry based on the PW associated with the AS and learns that the next hop is PE2 and the PW label is L1. PE1 then searches the public LSP based on the next hop (PE2) and obtains the outer label L2. As a result, PE1 encapsulates an MPLS header and pushes the inner label L1 and outer label L2 to the Layer packet and sends it to P. P forwards the MPLS packet based on the label and the PHP P pops out the outer label and sends the packet to PE2. Upon receipt of the packet, PE2 searches the PW ID entry based on the inner label L1, learns the outgoing interface (that is, the egress AC), pops out the inner label, and directly sends the Layer 2 packet to the destination CE4.

-
- ☑ After enabling the port protection mode on the member ports of the AC in L2VPN, the port protection mode does not take effect for the non-Trunk member ports.
 - ☑ The DHCP packets cannot be transmitted transparently after the `ip dhcp snooping` command is enabled.
 - ☑ The QoS policy for the DSCP matching does not take effect for the MPLS packets.
-

2.2 Configuring VPWS

Introduction to VPWS

As an end-to-end bearer technology of Layer 2 services, VPWS is a P2P L2VPN. On two PEs in a PSN, VPWS uses the LDP as the signaling to simulate various Layer 2 services of a CE through the MPLS LSP, including ATM, FR, VLAN, Ethernet and PPP. Moreover, the MPLS network can provide traditional IP, MPLS L3VPN and other services. Simply speaking, MPLS L2VPN is to transmit users' layer-2 data transparently on the MPLS network.

❖ Signaling protocol of VPWS

VPWSs can be divided into Martini and Kompella VPWSs by signaling protocols. Martini VPWSs adopt the LDP protocol as the signaling protocol, while Kompella VPWSs adopt the BGP protocol as the signaling protocol.

❖ Intercommunication of heterogeneous mediums of VPWS

When CEs on two ends of the same L2VPN feature different link types, L2VPN's feature of heterogeneous medium intercommunication will be needed. According to the suggestion of draft-kompella-ppvpn-l2vpn, to establish the L2VPN connection, the encapsulation type of the L2VPN interface of PEs is ip-interworking. Users' layer-3 data (IP packets) is transmitted on the MPLS network transparently.

2.2.1 Configuring Martini VPWS

- It is recommended to set PW as the **ethernetvlan** mode if VPLS service is provided on switches through Trunk access or on routers through sub-interface access.
- For QSW-6510 products, DHCP packets cannot be transmitted transparently after the **ip dhcp snooping** command is enabled.
- For QSW-6510 series products, VPLS can be bound to only one port.
- For QSW-6510 series products, VPLS instances are only supported by SVI interfaces and a VPLS instance can be bound to only one SVI interface.
- For QSW-6510 series products, one VPLS instance can be configured with mixed access modes. For example, PEs in one VPLS instance is configured with both Access and Trunk access modes. In such case, it is recommended to set the VPLS PW encapsulation mode on the PEs to the **ethernetvlan** mode.

2.2.1.1 Configuring a Public Tunnel

You must set up an LSP on the public network to carry VC services. To run MPLS on the backbone network, you must enable LDP on P and PEs at the same time to set up a public tunnel. This means that you have to configure LDP on the routers and enable MPLS on each interface. The configuration procedure is as follows:

Command	Function
Qtech# configure terminal	Enter the global configuration mode.
Qtech (config)# mpls ip	Enable MPLS globally.  Caution This command is inapplicable for switch chip forwarding.
Qtech (config)# mpls router ldp	Enable LDP and enter the MPLS routing configuration mode.
Qtech (config-mpls-router)# ldp router-id interface loopback id [force]	Configure the LDP router ID. The IP address of the loopback interface is generally used as the router ID.
Qtech (config-mpls-router)# exit	Quit the MPLS routing configuration mode.
Qtech (config)# interface type ID	Enter the public interface configuration mode.
Qtech (config-if-type ID)# ip address ip-address mask	Assign an IP address to the interface.
Qtech (config-if-type ID)# label-switching	Enable MPLS forwarding on the interface at the public network side.
Qtech (config-if-type ID)# mpls ip	<input checked="" type="checkbox"/> Enable LDP on the interface.

Qtech (config-if-type ID)# ip ref	For routers, the fast-forwarding function of the interface must be enabled. Switches do not need to use this command.
Qtech (config-if-type ID)# show running-config	Display all configuration information.

Configure an MPLS network.

```
Qtech# configure terminal
Qtech(config)# mpls router ldp
Qtech(config mpls router)# )# ldp router id interface loopback 0 force
Qtech(config mpls router)# exit
Qtech(config)# interface gigabitethernet 1/1
```

The **no switchport** command is used to switch the port mode on switches to routed port mode. It is not applicable to routers. You are not required to run this command on routers.

```
Qtech(config if gigabitethernet 1/1)# no switchport
# For routers, the fast-forwarding function of the interface must be enabled. Switches do not need to use this command.
Qtech(config if gigabitethernet 1/1)# no switchport
Qtech(config if gigabitethernet 1/1)# ip address 192.168.10.1 255.255.255.0
Qtech(config if gigabitethernet 1/1)# label switching
Qtech(config if gigabitethernet 1/1)# mpls ip
```

2.2.1.2 Configuring Remote LDP Peers

The setup and maintenance of a PW is completed by the extended LDP. If other LSRs exist between two PEs, you should adopt the extended LDP discovery mechanism to set up a remote LDP session between the PEs and assign PW labels in the session. The procedures to configure a remote LDP peer and setting up a remote LDP session are as follows:

Command	Function
Qtech# configure terminal	Enter the global configuration mode.
Qtech (config)# mpls router ldp	Enable LDP and enter the LDP configuration mode.
Qtech (config-mpls-router)# neighbor ip-address	Configure a remote LDP session.
Qtech (config-mpls-router)# show running-config	Display all configuration information.

Configure a remote LDP peer at 3.3.3.3.

```
Qtech# configure terminal
Qtech(config)# mpls router ldp
Qtech(config mpls router)# neighbor 3.3.3.3
Qtech(config)# exit
```



Caution

The PW label messages of the LDP are not affected by the LDP label distribution mode or label retention mode. The LDP works in the DU and liberal label retention mode.

2.2.1.3 Configuring User Access VPWS

Switch VPWS Access Method

The services of user access VPWS on the switch include several modes. According to whether the packet carries VLAN TAG, the user access can be divided into the following modes:

- 1) Access port access
- 2) Trunk interface access
- 3) Dot1q Tunnel port access

Only the VLAN interface (SVI interface of switches) can provide the VPWS service. IP and VPWS services cannot be enabled concurrently on the VLAN interface.



Note VPWS services are supported by only VLAN interfaces (that is, SVI interfaces on switches). In addition, the VLAN must have only one member interface. You cannot enable both IP and VPWS services on VLAN interfaces.



Note One VLAN interface can be bound to only one VC instance. The same VC instance cannot be bound to different VLAN interfaces.



Note When the **xconnect** command is used to specify the neighbor address of the VC peer end, you must use the Router ID of this peer end as the Peer address and the Router ID must be the 32-bit address of the Loopback interface.



Note After enabling the port protection mode on the member ports of the AC end of L2VPN, the port protection mode does not take effect for the non-Trunk member ports.

These access methods are described in detail as follows.

❖ VLAN Access Interface Access

The VLAN access interface access is applicable to the transmission of user packets that are not encapsulated through 802.1q (that is, packets without VLAN tags) on ACs. Enter the privilege mode and perform the following configuration procedure:

Command	Function
Qtech# configure terminal	Enter the global configuration mode.
Qtech (config)# interface type ID	Enter the interface configuration mode.
Qtech (config-if-type ID)# switchport mode access	Set the interface to work in access mode.

Qtech (config-if-type ID)# switchport access vlan <i>vlan-id</i>	Set the interface as a member interface of a VLAN.
Qtech (config-if-type ID)# exit	Quit the interface configuration mode.
Qtech (config)# interface vlan <i>vlan-id</i>	Create and enter the VLAN interface configuration mode.
Qtech (config-if-type ID)# xconnect <i>vc_id</i> <i>vc_peer</i> encapsulation mpls { ethernet ethernetvlan } raw	Create a VC and configure the raw encapsulation mode.
Qtech (config-if-type ID)# show running-config	Display all configuration information.

Configure **GigabitEthernet 1/1** as an access port and configure VPWS services for the corresponding VLAN interface.

```
Qtech# configure terminal
Qtech(config)# interface gigabitEthernet 1/1
Qtech(config if gigabitEthernet 1/1)# switchport mode access
Qtech(config if gigabitEthernet 1/1)# switchport access vlan 2
Qtech(config if gigabitEthernet 1/1)# exit
Qtech(config)# interface vlan 2
Qtech(config if vlan 2)# xconnect 2 2.2.2.2 encapsulation mpls ethernet raw
```



Caution

In the access interface access mode, the PW encapsulation mode cannot be set to tagged. It must be raw. You can flexibly configure the PW type as required.

❖ VLAN Trunk Interface Access

The VLAN trunk interface access is applicable to the transmission of VPWS services from several users on the same AC. The PE determines the VPWS services for user packets based on their VLAN tags and provides the multiplexing of access interfaces.

Enter the privilege mode and perform the following configuration procedure:

Command	Function
Qtech# configure terminal	Enter the global configuration mode.
Qtech (config)# interface <i>type ID</i>	Enter the interface configuration mode.
Qtech (config-if-type ID)# switchport mode trunk	Set the interface to work in trunk mode.
Qtech (config-if-type ID)# switchport trunk allow vlan add <i>vlan-list</i>	Set the trunk link to allow VLAN traffic.
Qtech (config-if-type ID)# exit	Quit the interface configuration mode.
Qtech (config)# interface vlan <i>vlan-id</i>	Create and enter the VLAN interface configuration mode.
Qtech (config-if-type ID)# xconnect <i>vc_peer</i> <i>vc_id</i> encapsulation mpls ethernetvlan tagged	Create a VC and configure the tagged encapsulation mode.

Qtech (config-if-type ID)# show running-config	Display all configuration information.
---	--

Configure **Gigabitethernet 1/1** as access access and configure VPWS services for the corresponding VLAN interface.

```
Qtech# configure terminal
Qtech(config)# interface gigabitethernet 1/1
Qtech(config if gigabitethernet 1/1)# switchport mode trunk
Qtech(config if gigabitethernet 1/1)# switchport trunk allowed vlan add 2 3
Qtech(config if gigabitethernet 1/1)# exit
Qtech(config)# interface vlan 2
Qtech(config if vlan 2)# xconenct 2 2.2.2.2 encapsulation mpls ethernetvlan tagged
Qtech(config if vlan 2)# exit
Qtech(config)# interface vlan 3
Qtech(config if vlan 2)# xconenct 3 2.2.2.2 encapsulation mpls ethernetvlan tagged
```



Note In the trunk interface access mode, the PW encapsulation mode cannot be set to raw. It must be tagged.



Note The L2 VPN service cannot be bound to the Native VLAN of the Trunk interface.

❖ **VLAN Tunnel Interface Access**

The VLAN tunnel interface access is applicable to the transmission of user service packets that carry private VLAN tags on the ACs when a user accesses VPWS services. In this mode, the PE forwards all packets received from the VLAN tunnel interface without any changes. This mode requires the VLAN member interfaces that connect PEs and CEs to work in tunnel mode.

Enter the privilege mode and perform the following configuration procedure:

Command	Function
Qtech# configure terminal	Enter the global configuration mode.
Qtech (config)# interface type ID	Enter the interface configuration mode.
Qtech (config-if-type ID)# switchport access vlan-id	Set the interface as a VLAN member interface.
Qtech (config-if-type ID)# switchport mode dot1q-tunnel	Set the interface to work in tunnel mode.
Qtech (config-if-type ID)# exit	Quit the interface configuration mode.
Qtech (config)# interface vlan vlan-id	Create and enter the VLAN interface configuration mode.
Qtech (config-if-type ID)# xconnect vc_id vc_peer encapsulation mpls ethernet raw	Create a VC and configure the raw encapsulation mode.

```
Qtech ( config-if-type ID )# show
running-config
```

Display all configuration information.

Configure **Gigabitethernet 1/1** as VLAN tunnel access and configure VPWS services for the corresponding VLAN interface.

```
Qtech# configure terminal
Qtech(config)# interface gigabitethernet 1/1
Qtech(config if gigabitethernet 1/1)# switchport mode dot1q tunnel
Qtech(config if gigabitethernet 1/1)# switchport access 2
Qtech(config if gigabitethernet 1/1)# exit
Qtech(config)# interface vlan 2
Qtech(config if vlan 2)# xconenct 2 2.2.2.2 encapsulation mpls ethernet raw
Qtech(config if vlan 2)# exit
```



Note

For the access mode of the VLAN tunnel port, it is recommended to set the PW type as Ethernet and the encapsulation mode must be RAW.



Note

For the access mode of the VLAN tunnel port, only the basic QinQ is supported, and flexible QinQ is not supported.

Router VPWS Access Method

There are several ways for users to access VPWS services provided by routers. Users can choose methods according to actual application needs. Services provided by the VPWS depend on the link protocol adopted by the interface that connects the PE with the CE. Currently, the following four point-to-point L2VPN services are supported:

1. Simulative Ethernet line service
2. Simulative 802.1Q line service
3. Simulative PPP line service
4. Simulative HDLC line service

For the PE, the four L2VPN line services are corresponding to four access modes.



Note

You cannot enable both IP and VPWS services on VLAN interfaces.



Note

One VLAN interface can be bound to only one VC instance. The same VC instance cannot be bound to different VLAN interfaces.

-
- For the router product, only the express forwarding function on the interface connected to the access user VPWS and the WAN is enabled, can the VPWS services work normally.
-



Note To use the **xconnect** command to specify the address of the VC's peer neighbor, the peer Router ID must be applied as the peer address, and the peer Router ID must be the 32-bit address of the Loopback interface.

❖ Ethernet Access

In this scenario, the interface that connects PE with CE encapsulates the Ethernet link protocol and provides the VPWS service. CE is connected to PE through the Ethernet link and requests Etherframe transmitted transparently by PE. The Ethernet interface access method applies to the situation that when users access the VPWS service, the user service packets transmitted on the access link carry private Vlan tags or do not carry Vlan tags. In this mode, all packets received by PE from the interface will be forwarded without being processed.

Enter the privilege mode and perform the following configuration procedure:

Command	Function
Qtech# configure terminal	Enter the global configuration mode.
Qtech (config)# interface type ID	Enter the interface configuration mode.
Qtech (config-if-type ID)# xconnect vc_peer vc_id encapsulation mpls ethernet raw	Create a VC and configure the Ethernet PW Type and the raw encapsulation mode.
Qtech (config-if-type ID)# ip ref	<input checked="" type="checkbox"/> For routers, the fast-forwarding function of the interface must be enabled. Switches do not need to use this command.
Qtech (config-if-type ID)# show running-config	Display all configuration information.

Configure the VPWS services on the Ethernet access interface **Gigabitethernet 1/1**.

```
Qtech# configure terminal
Qtech(config)# interface gigabitethernet 0/1
```

The express forwarding function must be enabled on the router interface:

```
Qtech(config if gigabitethernet 1/1)# ip ref
Qtech(config if gigabitethernet 0/1)# xconnect 2.2.2.2 2 encapsulation mpls ethernet raw
Qtech(config if gigabitethernet 0/1)# exit
```

❖ Ethernet Sub-interface Access

In this scenario, the interface that connects PE with CE encapsulates the 802.1Q link protocol and provides the VPWS service. CE is connected to PE through the Ethernet sub-interface and requests Etherframes transmitted transparently by PE. The Ethernet sub-interface access method applies to the situation that several VPWS services for multiple users are transmitted on an access physical link. PE devices can match packets with VPWS services according to dot1q tags carried by the user

packets, and provide the access port multiplier mode. To adopt the access mode, packets sent by CE to PE must carry vlan tags.

Enter the privilege mode and perform the following configuration procedure:

Command	Function
Qtech# configure terminal	Enter the global configuration mode.
Qtech (config)# interface type ID	Enter the interface configuration mode.
Qtech (config-if-type ID)# xconnect vc_peer vc_id encapsulation mpls ethernetvlan tagged	Create a VC and configure the Ethernetvlan PW Type and the tagged encapsulation mode.
Qtech (config-if-type ID)# ip ref	<input checked="" type="checkbox"/> For routers, the fast-forwarding function of the interface must be enabled. Switches do not need to use this command. Use the command to configure the sub-interface's fast-forwarding function on its master interface.
Qtech (config-if-type ID)# show running-config	Display all configuration information.

Configure **GigabitEthernet 1/1** as access access and configure VPWS services for the corresponding VLAN interface.

```
Qtech# configure terminal
Qtech(config)# interface gigabitEthernet 0/1.1
Qtech(config if gigabitEthernet 0/1.1)#encapsulation dot1Q 1
```

For routers, the fast-forwarding function of the interface must be enabled. Switches do not need to use this command.

```
Qtech(config if gigabitEthernet 1/1)# ip ref
Qtech(config if gigabitEthernet 0/1.1)# xconnect 2.2.2.2 2 encapsulation mpls ethernetvlan tagged
Qtech(config if gigabitEthernet 0/1.1)# exit
```



Note

If the VPWS service is enabled on both master interface and sub-interface, or is enabled on one of them, packets without Vlan tag received by the Ethernet interface belong to the service provided by the master interface. If they carry Vlan tag and match with the sub-interface's Vlan ID, they belong to the service provided by the sub-interface.



Note

To enable the sub-interface to support the fast-forwarding function, the fast-forwarding must be enabled on its master interface using the **ip ref** command.



Note Users can use `mpls mtu` command to modify the MPLS MTU value. By default, it is equal to the MTU value of the interface.

2.2.1.4 Configuring Heterogeneous Medium Communication VPWS

When CEs on two ends of the same L2VPN feature different link types, L2VPN's feature of heterogeneous medium intercommunication will be needed. According to the suggestion of draft-kompella-ppvpn-l2vpn, to establish the L2VPN connection, the encapsulation type of the L2VPN interface of PEs is ip-interworking. Users' IP packets are transmitted on the MPLS network transparently. When the L2VPN's heterogeneous medium communication function is used, VPWS service interfaces of PEs on both ends must encapsulate ip-interworking; after PW connection is set up, process packets as follows:

1. After PE receives packets from CE and decapsulate the link layer, it will transmit the IP packets to the MPLS network.
2. The IP packets will be transmitted transparently through the MPLS network to the peer PE.
3. The peer PE will re-encapsulate the IP packets according its link layer protocol type and sends them to the CE connects to it.
4. The link layer controlling packet (such as PPP's IPCP) sent by CE will be processed by PE and will not be transmitted in the MPLS network.
5. Non-IP packets (such as MPLS packets) will be discarded and will not enter the MPLS network.

❖ Among the Ethernet interfaces on PE, L2VPN interfaces that can be encapsulated in the ip-interworking mode include:

1. Ethernet interface or sub-interface
2. GigabitEthernet interface or sub-interface

Note the following points:

1. After being encapsulated as ip-interworking, the PE's Ethernet interface will only process ARP and IP packets received by the local CE and discard the others, including IPv6 packets;
 2. When PE receives IP packets from CE, the dynamic MAC will not be updated;
 3. If the VPWS import interface that encapsulates ip-interworking on PE receives CE's ARP request packets, no matter what the destination IP is, it will use the PE's MAC address to reply;
 4. Each Ethernet interface or sub-interface of PE can only be connected to one CE and cannot to multiple CEs or other devices through HUB or a layer-2 switch. Otherwise, PE's learned MAC address will be covered, obstructing the forwarding;
- ❖ If CE uses the PPP link protocol to access PE, pay attention to the following points:

1. Unlike the negotiation that provides the homogeneous medium L2VPN PPP simulative line service, the negotiation of PPP is conducted between CE and PE, rather than CEs; the address of the negotiation between PE and CE will not generate the corresponding route.

2. It supports PAP and CHAP authentication. The authentication method is the same as the ordinary situation;

3. It does not support IPHC compression;

4. It supports transparent transmission of IP packets from the local-end CE to the peer CE. However, it does not support transparent transmission through protocols such as MPLS and IPv6.

2.2.1.5 Configuring Inter-AS VPWS

There are two solutions for configuring Inter-AS Martini VPWS:

- ❖ **Inter-AS Option A:** This solution is simple and can be adopted when the number of L2VPNs on ASBR is small.

- ❖ Inter-AS Option C: No VC is needed to be created or maintained on ASBR. When each AS has numerous cross-L2VPNs, this solution can be applied to solve the bottleneck of the ASBR's scalability.

❖ Inter-AS Option A

Figure 1-4 Option A Inter-AS VPWS

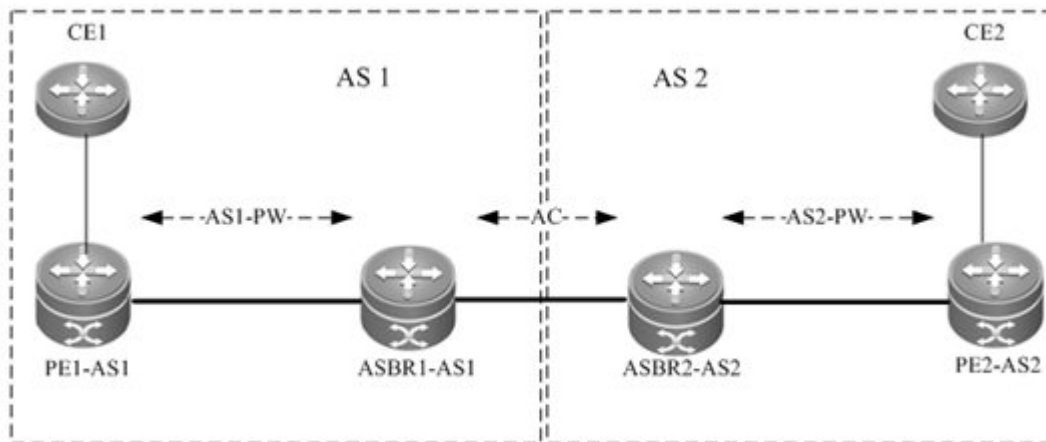

In the solution, ASBRs of two ASs are connected with each other and PEs of their respective autonomous systems. Each ASBR considers the peer ASBR as its CE device. As shown in the above figure, for ASBR1-AS1 of AS1, ASBR2-AS2 of AS2 is only its CE device; for ASBR2-AS2, ASBR1-AS1 is also only an imported CE device.

The Option A solution is easy to realize. Two PE that serve as ASBRs do not need to be configured especially and the interface between ASBRs does not need an IP address. The shortcoming of the solution is that for each Inter-AS L2VPN or each Inter-AS PW, a link must be allocated between ASBRs of two ASs. The link can be logical or physical. When there are numerous Inter-AS PWs, they will cause great pressure to ASBRs and hinder the expansion.

The solution's configuration is similar with the above-mentioned basic VPWS configuration.

Inter-AS Option C

Figure 1-5 Option C Inter-AS VPWS

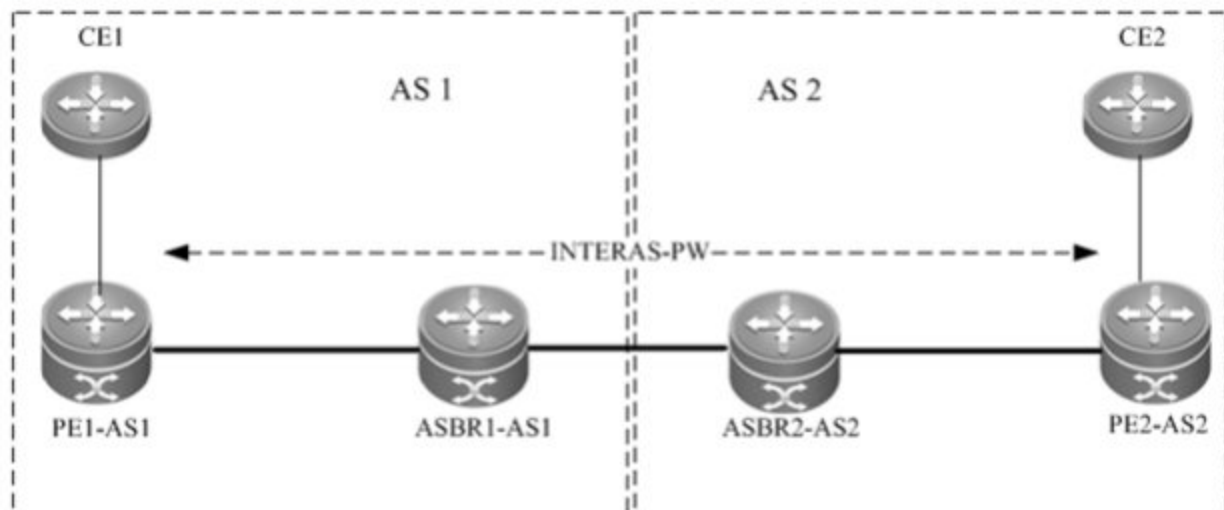

As shown in the above figure, Option C solution is to set up an Inter-AS PW on two ASs directly and exchange PW tags. The principle is described as follows:

By sending tag IPv4 routes to PE in respective ASs and sending tag IPv4 routes received by PEs in respective ASs to the ASBR peers of peer ASs, ASBRs connect the tunnel between two ASs and set up a LSP tunnel between the ingress PE and egress PE; then, the Inter-AS LDP remote session will be set up between PEs in different ASs and PW information will be exchanged.

In the solution, ASBRs do not need to maintain Inter-AS L2VPN information or prepare a physical or logical interface for the Inter-AS L2VPN. But it needs to provide a MPLS tunnel. The L2VPN information is directly exchanged between PEs. Therefore the pressure on ASBRs is decreased, boosting the scalability.

The configuration process is described as follows:

1. Configuring MPLS signaling
2. Configuring PEs
3. Configuring ASBRs
4. Configuring the remote LDP session
5. Configuring the user access VPWS

❖ Configuring MPLS signaling

In each AS, enable the MPLS and LDP functions on PE and P devices and the interface that connects to the P or PE device in AS of the ASBR to set up a basic MPLS network. See the chapter about basic MPLS configuration for the configuration procedures.

❖ Configuring PEs

Configure the PEs in ASs, set up an IBGP session between PE and the AS, and exchange IPv4 routes that carry tags.

Command	Function
Qtech# config terminal	Enter the global configuration mode.
Qtech (config)# router bgp <i>asn-number</i>	Configure BGP protocol and enter the BGP configuration mode.
Qtech (config-router)# neighbor <i>asbr-address</i> remote-as <i>asbr-asn-number</i>	Set up IBGP session between PE and ASBR.
Qtech (config-router)# neighbor <i>asbr-address</i> update-source <i>interface-name</i>	Configure using the Loopback address as the source address of the BGP session set up between peers.
Qtech (config-router)# address-family ipv4	Enter the IPv4 address family.
Qtech (config-router-af)# neighbor <i>asbr-address</i> send-label	Enable IPv4 route tag switching.
Qtech (config-router-af)# show running-config	Display configuration information.

Set up the IBGP session with the ASBR device 10.10.10.2 and enable the IPv4 route tag switching capability.

```
Qtech# configure terminal
Qtech(config)# router bgp 1
Qtech(config router)# neighbor 10.10.10.2 remote as 1
Qtech(config router)# neighbor 10.10.10.2 update source loopback 0
Qtech(config router)# address family ipv4
Qtech(config router af)# neighbor 10.10.10.2 activate
Qtech(config router af)# neighbor 10.10.10.2 send label
Qtech(config router af)# exit
```

❖ Configure ASBR

Configure ASBR to set up the IBGP session with the PE in the same AS and with the ASBR in the other AS. Enable the IPv4 route tag switching function on both sessions. Configure the PE address to be transmitted to another ASBR on the ASBR.

Command	Function
Qtech# config terminal	Enter the global configuration mode.
Qtech (config)# mpls ip	Enable the device to support MPLS forwarding. This command is inapplicable for switch chip forwarding.
Qtech (config)# mpls router ldp	Enable LDP protocol globally.
Qtech (config-mpls-router)# ldp router-id <i>interface</i> Loopback <i>id</i> force	Configure the IP address of the Loopback interface as Router ID.
Qtech (config-mpls-router)# advertise-labels for bgp-routes	Allocate tags for BGP protocol's route.
Qtech (config-mpls-router)# exit	Return to the config mode.
Qtech (config)# router bgp <i>asn-number</i>	Configure BGP protocol and enter the BGP configuration mode.

Qtech (config-router)# neighbor asbr-address remote-as asbr-asn-numbe	Configure setting up EBGP session with ASBR.
Qtech (config-router)# neighbor pe-address remote-as asn-number	Configure setting up EBGP session with PE.
Qtech (config-router)# neighbor pe-address update-source loopback id	Configure using the Loopback address as the source address of the BGP session set up between PE peer.
Qtech (config-router)# address-family ipv4	Enter the IPv4 address family.
Qtech (config-router-af)# network pe-address mask mask-value	(Optional) Use the network command to import the PE route received to BGP. The IGP protocol can be re-distributed to import the route.
Qtech (config-router-af)# neighbor asbr-address send-label	Enable the IPv4 route tag switching capability on the BGP set up with the ASBR in another autonomous domain.
Qtech (config-router-af)# neighbor pe-address send-label	Enable the IPv4 route tag switching capability on the BGP set up with the PE in the same autonomous domain.
Qtech (config-router-af)# neighbor asbr-ip-address route-map name out	(Optional) Configure the route allocation strategy. Define route map rules (Routemap) to control allocation of routes to neighbors and control whether these routes carry tags when they are sent.
Qtech(config-router-af)# neighbor asbr-ip-address route-map name in	(Optional) Configure the route allocation policy. Define route map rules (Routemap) to control only routes that carry tags.
Qtech(config-router-af)# show running-config	Display configuration information.

In the following example, the configured ASBR sets up an EBGP session with the ASBR in another autonomous domain (30.30.30.2) and the tag switching capability is enabled for IPv4 route; the IBG neighbor is created between the ASBR and the PE in the same autonomous domain (10.10.10.1) and the tag switching capability is enabled for IPv4 route.

```
Qtech# configure terminal
Qtech(config)# router bgp 1
Qtech(config router)# neighbor 30.30.30.2 remote as 2
Qtech(config router)# address family ipv4
Qtech(config router af)# neighbor 30.30.30.2 activate
Qtech(config router af)# neighbor 30.30.30.2 send label
Qtech(config router af)# exit
Qtech(config router)# neighbor 10.10.10.1 remote as 1
Qtech(config router)# neighbor 10.10.10.1 update source loopback 0
Qtech(config router)# address family ipv4
Qtech(config router af)# neighbor 10.10.10.1 send label
Qtech(config router af)# exit
```



Note For the IBGP session set up between ASBR and the PE in the same AS, the **neighbor peer-address update-source loopback id** command must be used on the ASBR and PE to configure the address of the device's Loopback interface as the source address of the session. Otherwise, the Inter-AS LSP tunnel cannot be established.



Note The direct EBGP session established between ASBRs usually use the direct connection interface's address as the source address of the BGP session to ensure that both ASBRs have routes that lead to each other. Therefore, we do not recommend using the **neighbor peer-address update-source loopback id** command on the EBGP session established based on direct connection to configure the address of the device's Loopback interface as the source address of the session. If necessary, use the **neighbor ebgp-multihop** command to enable the multi-hop EBGP function. Configure the static route on ASBR to ensure that the route can lead to the peer. Configure the static FTN to ensure that the Inter-AS LSP's tunnel is through.



Note The **label-switching** command must be used on the interface that connects two ASBRs to enable the interface's MPLS packet forwarding.

❖ Configure the LDP remote session

Set up an Inter-AS LDP remote session between PEs in two autonomous domains. See the [Configuring LDP Remote Peer](#) chapter.

❖ Configure the user access VPWS

See the [Configuring User Access VPWS](#) chapter for the detailed configuration.

❖ Check the configuration result.

Command	Function
show bgp ipv4 unicast labels	Display label information allocated by BGP for IPv4 route.
show mpls ldp neighbor	Display neighbor information of LDP.
show mpls l2transport vc [detail]	Display VC status information.

Display route and label information on ASBR or PE.

```
Qtech # show bgp ipv4 unicast labels
Network      Next Hop      In Label/Out Label
1.1.1.1/32   192.167.1.1   17/18
1.1.1.2/32   192.167.1.1   no-label/19
```

Field	Definition
Network	Route prefix
NextHop	Route's next hop
In Label	Label (if any) allocated by the router

Out Label	Label (if any) learned from the next-hop router of the route
-----------	--

Display LDP session information on PE.

```
Qtech # show mpls ldp neighbor
Default VRF:
  Peer LDP Ident: 10.20.10.10:0; Local LDP Ident: 8.8.8.8:0
  TCP connection: 10.20.10.10.62488 8.8.8.8.646
  State: OPERATIONAL; Msgs sent/rcv: 42/45; UNSOLICITED
  Up time: 00:33:49
  LDP discovery sources:
    Link Peer on GigabitEthernet 2/1, Src IP addr: 192.168.201.220
    Targeted Hello 8.8.8.8 > 10.20.10.10
  Addresses bound to peer LDP Ident:
    10.20.10.10 192.168.201.220 192.168.198.1 10.5.0.1
```

Field	Definition
Peer LDP Ident	LDP identifier of the peer neighbor of the LDP session
Local LDP Identifier	The router's LDP identifier
TCP connection	TCP connection that supports the LDP session
State	Status of the LDP session
Msgs sent/rcv	Quantity of LDP message sent to/received by the session peer
UNSOLICITED and ONDEMAND	Label allocation mode

Display VC status information.

```
Qtech # show mpls l2transport vc detail
Local interface : VLAN 2, AC state: up
Peer address: 192.168.0.1 ,VC ID: 2, VC status: up
VC type: vlan VC mode:tagged
Group id: 0 MTU: 1500
Control Word not support
Output interface: VLAN 300 , imposed label stack {22 ,501 }
MPLS VC label: local 22, remote 22
```

Field	Definition
Local interface	Local interface bound to VC
AC state	AC status, up or down
Peer address	Peer IP address
VC ID	VC's unique identifier
VC status	VC status, up or down
VC type	VC type
VC mode	VC mode, tagged or raw (only applies to the Ethernet access mode)
Group id	VC's local group ID

MTU	MTU of locally-configured VC
Control Word	Whether control word is supported
Output interface	Output interface on the public network used to transmit the VC process
imposed label stack	Added label stack
MPLS VC label	Local indicates the label locally allocated for the VC, while Remote indicates the label allocated by the peer for the VC.

Configuring Kompella VPWS

2.2.1.6 Configuring Public Network Tunnel

The LSP tunnel must be set up in the public network to provide the VC service. To run MPLS in the backbone network, the LDP protocol must be run on P and PE to establish the public network tunnel. This includes configuring the label allocation protocol for MPLS devices and enabling the MPLS forwarding on each interface. The configuration process is described as follows:

Command	Function
Qtech# config terminal	Enter the global configuration mode.
Qtech# mpls ip	Enable MPLS forwarding globally.  Caution This command is inapplicable for switch chip forwarding.
Qtech (config)# mpls router ldp	Enable LDP and enter the LDP configuration mode.
Qtech (config-mpls-router)# ldp router-id interface loopback id [force]	Configure LDP's Router ID, which is usually the IP address of the Loopback interface.
Qtech (config-mpls-router)# exit	Exit from the LDP configuration mode.
Qtech (config)# interface type ID	Enter the public network interface configuration mode.
Qtech (config-if-type ID)# label-switching	Enable the interface's MPLS forwarding function.
Qtech (config-if-type ID)# mpls ip	Enable the interface's LDP function and MPLS forwarding function.
Qtech (config-if-type ID)# ip ref	Enable the fast-forwarding function for routers. It does not need to be enabled for switches.
Qtech (config-if-type ID)# end	Return to the privileged mode.
Qtech# copy running-config startup-config	Save configuration.

#Configure the public network tunnel between PEs.

```
Qtech# configure terminal
Qtech(config)# mpls ip
Qtech(config)# mpls router ldp
Qtech(config mpls router)# ldp router id interface loopback 0 force
```

```

Qttech(config mpls router)# exit
Qttech(config)# interface gigabitethernet 1/1
Qttech(config if GigabitEthernet 1/1)# label switching
Qttech(config if GigabitEthernet 1/1)# mpls ip
Qttech(config if GigabitEthernet 1/1)# ip ref
Qttech(config if GigabitEthernet 1/1)# end
Qttech# copy running config startup config

```



Note As the LDP protocol is topology-driven, the IPv4 route protocol must be enabled and work properly to allow IDP to work properly.

2.2.1.7 Configuring L2VPN Address Family

Kompella VPWS uses MP-BGP4 as the signaling protocol to transmit layer-2 information and VC labels, thus realizing point-to-point VPN. In addition, the MP-BGP4 protocol can be used as the auto-discovery protocol and connect remote CEs. Procedures for enabling the L2VPN address family are as follows:

Command	Function
Qttech# configure terminal	Enter the global configuration mode.
Qttech (config)# router bgp asn-num	Create the BGP and enter the BGP configuration mode.
Qttech (config)# neighbor peer-address remote-as asn-number	Set up IBGP session.
Qttech (config)# neighbor peer-address update-source interface-name	Configure the IBGP session to use the address of the Loopback interface as the session's source address.
Ruiije (config-router)# address-family l2vpn vpws	Enter L2VPN VPWS address family.
Qttech (config-router-af)# neighbor ip-address activate	Activate switching of l2vpn information on the BGP session.
Qttech (config-router-af)# neighbor { ip-address peer-group-name } send-community [both standard extended]	Specify the extended community attribute to be sent to BGP neighbors.
Qttech (config-router-af)# end	Return from address family configuration mode to privileged mode.
Qttech# show bgp l2vpn vpws { all [id:offset neighbor ip-address summary] }	Display L2VPN address family information.

Configure L2VPN address family and enable VPWS information switching.

```

Qttech# configure terminal
Qttech(config)# router bgp 100
Qttech(config router)# neighbor 10.10.10.1 remote as 1
Qttech(config router)# neighbor 10.10.10.1 update source loopback 0
Ruiije(config router)# address family l2vpn vpws

```

```

Qttech(config router af)# neighbor 10.10.10.1 activate
Qttech(config router af)# neighbor 10.10.10.1 send community extended
Qttech(config router af)# end
Qttech# show bgp l2vpn vpws all

```

2.2.1.8 Configuring Kompella VPWS Instance

The **l2 vfi** command can be used to create Kompella VPWS instances or enter the Kompella VPWS configuration mode. The **no l2 vfi** command can be used to delete VFI instances. The sole local VFI instance name and the sole local device VPN ID must be specified when the instance is being created. The auto-discovery must be enabled for the specified VFI instance. The VFI name should correspond to the VPN ID.

The **label-saving** command can be used to enable the label saving mode and allocate a label for the specified remote site. In the label saving mode, **site range** will not take effect.

- For switches, the VLAN bound with VPWS has only one member port, which cannot be changed. After the VLAN member port is changed, the VLAN should be bound with VPWS again.

Command	Function
Qttech# config terminal	Enter the global configuration mode.
Qttech (config)# l2 vfi vpls-name vpnid vpn-id point-to-point	Create the Kompella VPWS instance and enter the VPWS configuration mode.
Qttech (config-vfi)# rd rd_value	First configure RD and configure RD value.
Qttech (config-vfi)# encapsulation mpls [ethernet ethernetvlan ip-interworking]	Specify Kompella L2VPN PW's encapsulation type, which is Ethernet by default.
Qttech (config-vfi)# route-target { import export both } rt_value	Configure RTs. Multiple RTs can be configured.
Qttech (config-vfi)# site-id id [site-range size]	Configure the site's CE ID and site-range. If the site-range is not configured, the default value of 16 will be adopted. Multiple Site IDs can be configured for Kompella VPWS.
Qttech (config-vfi-site)# xconnect interface interface-type interface-number remote-ce-id id	Bind the local interface and specify the remote CE ID to be connected.
Qttech (config-vfi-site)# end	Return to the privileged mode.
Qttech# copy running-config startup-config	Save configuration.

Configure a Kompella VPWS instance.

```

Qttech#configure terminal
Qttech(config)# l2 vfi vpls 1 vpnid 1 point to point
Qttech(config vfi)# rd 100:1
Qttech(config vfi)# encapsulation mpls ethernet
Qttech(config vfi)# route target both 4500:2
Qttech(config vfi)# site id 1
Qttech(config vfi site)# xconnect interface gi 2/2 remote ce id 2
Qttech(config vfi site)#end

```

```
Qtech# copy running-config startup-config
```



Note The **point-to-point** key word must be specified after the **I2 vfi** command to create a Kompella VPWS.



Note To facilitate management, VFI instances of one VPN should be configured with the same ID.



Note Each site's ID is globally unique in VFI instances.



Note VFI instances of all PEs on one VPN must be configured with the same VPWS PW type. Otherwise, BGP signaling cannot negotiate and establish PWs.



Note We recommend specifying the PW type as ethernetvlan for VPWS connected through the sub-interface and as Ethernet for VPWS connected through the Ethernet. If the interface type is different from the specified PW type, although PWs can be established, two PW types adopt different ways to process tags of user packets, causing problems to communication between CEs. In ethernetvlan PWs, vlan tags carried by user packets are processed as p-tags, while in Ethernet PWs, they are transmitted transparently as c-tags.

2.2.1.9 Configuring User Access VPWS

A created VFI instance will only take effect after the user configured with the VFI instance is connected with the link. Multiple point-to-point VCs can be configured in one VFI.

Switch VPWS access mode

Switches can only provide Ethernet VPWS services. The mode can be divided into the following modes according to whether packets carry Vlan Tags:

1. Access port access
2. Trunk interface access
3. VLAN tunnel port access



Note Only the VLAN interface (SVI interface of switches) can provide the VPWS service. IP and VPWS services cannot be enabled concurrently on the VLAN interface.



Note For switches, VLAN that binds VPWS can have only one member port, which cannot be changed. After the VLAN member port is changed, VPWS must be re-configured and bound.



Note One VLAN interface can only bind one VC instance and one VC instance cannot be bound on different VLAN interfaces.



Note When the port protection mode is enabled on the AC-end member port of L2VPN, if the corresponding member port is not a Trunk interface, the port protection mode will not take effect on the member port.

These access methods are described in detail as follows.

❖ Vlan access port access

This mode applies when user packets transmitted on the access link are not encapsulated by 802.1q (the packets do not carry VLAN tag). Enter the privileged mode and complete the following configuration procedures:

Command	Function
Qtech# configure terminal	Enter the global configuration mode.
Qtech (config)# interface type ID	Enter the interface configuration mode.
Qtech (config-if-type ID)# switchport mode access	Set the interface in the access mode.
Qtech (config-if-type ID)# switchport access vlan vlan-id	Set the interface as a member port of a vlan port.
Qtech (config-if-type ID)# exit	Exit from the interface configuration mode.
Qtech (config)# I2 vfi vfi_name vpnid vpn_id point-to-point	Enter the vfi configuration mode.
Qtech (config-vfi)# rd rd_value	Define the RD value of the Kompella VPWS instance.
Qtech (config-vfi)# route-target { import export both } rt_value	Configure RT.
Qtech (config-vfi)# encapsulation mpls ethernet	Configure the encapsulation method of VFI as Ethernet.
Qtech (config-vfi)# site-id id [site-range size]	Configure VFI's site information.
Qtech (config-vfi-site)# xconnect interface vlan vlan-id remote-ce-id id	Connect the interface that binds VFI locally with the VFI's remote CEs.



Caution In the VLAN access port access mode, we recommend choosing **Ethernet** as the PW encapsulation mode and the encapsulation modes on two ends of a PW must be the same.

Configure gigabitethernet 1/1 to be connected through the access port and configure VPWS service under the corresponding Vlan interface.

```

Qttech# configure terminal
Qttech(config)# interface gigabitethernet 1/1
Qttech(config if gigabitethernet 1/1)# switchport mode access
Qttech(config if gigabitethernet 1/1)# switchport access vlan 2
Qttech(config if gigabitethernet 1/1)# exit
Qttech(config)# l2 vfi vfiA vpnid 1 point to point
Qttech(config vfi)# rd 2:2
Qttech(config vfi)# route target both 2:2
Qttech(config vfi)# encapsulation mpls ethernet
Qttech(config vfi)# site id 1
Qttech(config vfi site)# xconnect interface vlan 2 remote ce id 2

```

❖ Vlan Trunk interface access

The Vlan Trunk interface access mode applies when several VPWS services for multiple users are transmitted on a access link. PE devices can match packets with VPWS services according to vlan tags carried by the user packets, and provide the access port multiplier mode.

Enter the privileged mode and complete the following configuration procedures:

Command	Function
Qttech# configure terminal	Enter the global configuration mode.
Qttech (config)# interface <i>type ID</i>	Enter the interface configuration mode.
Qttech (config-if- <i>type ID</i>)# switchport mode trunk	Set the interface in the trunk working mode.
Qttech (config-if- <i>type ID</i>)# switchport trunk allow vlan add <i>vlan-list</i>	Set the vlan flows allowed to be transmitted on the trunk link.
Qttech (config-if- <i>type ID</i>)# exit	Exit from the interface configuration mode.
Qttech (config)# l2 vfi <i>vfi_name</i> vpnid <i>vpn_id</i> point-to-point	Enter the vfi configuration mode.
Qttech (config-vfi)# rd <i>rd_value</i>	Define the RD value of the Kompella VPWS instance.
Qttech (config-vfi)# route-target { import export } both } <i>rt_value</i>	Configure RT.
Qttech (config-vfi)# encapsulation mpls ethernetvlan	Configure the encapsulation method of VFI as ethernetvlan.
Qttech (config-vfi)# site-id <i>id</i> [site-range <i>size</i>]	Configure VFI's site information.
Qttech (config-vfi-site)# xconnect interface vlan <i>vlan-id</i> remote-ce-id <i>id</i>	Connect the interface that binds VFI locally with the VFI's remote CEs.



Note In the Trunk access port access mode, we recommend choosing **ethernetvlan** as the PW encapsulation mode and the encapsulation modes on two ends of a PW must be the same.



Note

The L2 VPN service cannot be bound to the Native VLAN of the Trunk interface.

Configure **gigabitethernet 1/1** to be connected through the trunk interface and configure VPWS under the corresponding Vlan interface.

```
Qtech# configure terminal
Qtech(config)# interface gigabitethernet 1/1
Qtech(config-if-gigabitethernet 1/1)# switchport mode trunk
Qtech(config-if-gigabitethernet 1/1)# switchport trunk allowed vlan add 2 3
Qtech(config-if-gigabitethernet 1/1)# exit
Qtech(config)# l2 vfi vfiA vpnid 1 point-to-point
Qtech(config-vfi)# rd 2:2
Qtech(config-vfi)# route-target both 2:2
Qtech(config-vfi)# encapsulation mpls ethernetvlan
Qtech(config-vfi)# site-id 1
Qtech(config-vfi-site)# xconnect interface vlan 2 remote-ce-id 2
```

❖ Vlan tunnel port access

This mode applies when user service packets transmitted on the access link carry private Vlan tags when the user is connected to the VPWS service. In this mode, all packets received by PE from the interface will be forwarded without being processed. The mode requires the Vlan member port that connects PE with CE to work in the tunnel mode.

Enter the privileged mode and complete the following configuration procedures:

Command	Function
Qtech# configure terminal	Enter the global configuration mode.
Qtech (config)# interface type ID	Enter the interface configuration mode.
Qtech (config-if-type ID)# switchport access vlan-id	Set the interface Vlan member port.
Qtech (config-if-type ID)# switchport mode dot1q-tunnel	Set the interface to work in the tunnel mode.
Qtech (config-if-type ID)# exit	Exit from the interface configuration mode.
Qtech (config)# l2 vfi vfi_name vpnid vpn_id point-to-point	Enter the vfi configuration mode.
Qtech (config-vfi)# rd rd_value	Define the RD value of the Kompella VPWS instance.
Qtech (config-vfi)# route-target { import export both } rt_value	Configure RT.
Qtech (config-vfi)# encapsulation mpls ethernetvlan	Configure the encapsulation method of VFI as ethernetvlan.
Qtech (config-vfi)# site-id id [site-range size]	Configure VFI's site information.
Qtech (config-vfi-site)# xconnect interface vlan vlan-id remote-ce-id id	Connect the interface that binds VFI locally with the VFI's remote CEs.



Note In the VLAN tunnel port access mode, we recommend choosing **Ethernet** as the PW encapsulation mode and the encapsulation modes on two ends of a PW must be the same.



Note For the VLAN tunnel port access mode, only the basic QinQ is supported, and flexible QinQ is not supported.

Configure **gigabitethernet 1/1** to be connected through the vlan tunnel mode and configure VPWS under the corresponding Vlan interface.

```
Qtech# configure terminal
Qtech(config)# interface gigabitethernet 1/1
Qtech(config-if-gigabitethernet 1/1)# switchport mode dot1q-tunnel
Qtech(config-if-gigabitethernet 1/1)# switchport access 2
Qtech(config-if-gigabitethernet 1/1)# exit
Qtech(config)# vfi vfiA vpnid 1 point-to-point
Qtech(config-vfi)# rd 2:2
Qtech(config-vfi)# route-target both 2:2
Qtech(config-vfi)# encapsulation mpls ethernetvlan
Qtech(config-vfi)# site-id 1
Qtech(config-vfi-site)# xconnect interface vlan 2 remote-ce-id 2
```

Router VPWS access mode

There are several ways for users to connect to VPWS services provided by routers. Users can choose methods according to actual application needs. Services provided by the VPWS depend on the link protocol adopted by the interface that connects the PE with the CE. Currently, the following four point-to-point L2VPN services are supported:

1. Simulative Ethernet line service
2. Simulative 802.1Q line service
3. Simulative PPP line service
4. Simulative PPP line service

❖ Ethernet interface access

The Ethernet interface access mode applies when users access the VFI service, the user service packets transmitted on the access link carry private Vlan tags or do not carry Vlan tags. In this mode, all packets received by PE from the interface will be forwarded without being processed and the private tags are considered part of the data.

Command	Function
Qtech# configure terminal	Enter the global configuration mode.

Qtech (config)# interface <i>type ID</i>	Enter the interface configuration mode.
Qtech (config-if- <i>type ID</i>)# ip ref	Enable fast-forwarding of the Ethernet interface.
Qtech (config-if- <i>type ID</i>)# exit	Exit from the interface configuration mode.
Qtech (config)# I2 vfi <i>vfi_name vpnid vpn_id point-to-point</i>	Enter the vfi configuration mode.
Qtech (config-vfi)# rd <i>rd_value</i>	Define the RD value of the Kompella VPWS instance.
Qtech (config-vfi)# route-target { import export both } <i>rt_value</i>	Configure RT.
Qtech (config-vfi)# encapsulation mpls ethernet	Configure the encapsulation method of VFI as Ethernet.
Qtech (config-vfi)# site-id <i>id</i> [site-range <i>size</i>]	Configure VFI's site information.
Qtech (config-vfi-site)# xconnect interface <i>type ID remote-ce-id id</i>	Connect the interface that binds VFI locally with the VFI's remote CEs.

Configure gigabitethernet 1/0 to provide the VPWS service of transmitting Etherframes transparently.

```
Qtech# configure terminal
Qtech(config)# interface gigabitethernet 1/0
Qtech(config if gigabitethernet 1/0)# ip ref
Qtech(config if gigabitethernet 1/0)# exit
Qtech(config)# 12 vfi vfiA vpnid 1 point to point
Qtech(config vfi)# rd 2:2
Qtech(config vfi)# route target both 2:2
Qtech(config vfi)# encapsulation mpls ethernet
Qtech(config vfi)# site id 1
Qtech(config vfi site)# xconnect interface gigabitethernet 1/0 remote ce id 2
```



Caution In the Ethernet interface access mode, we recommend choosing **Ethernet** as the PW encapsulation mode and the encapsulation modes on two ends of a PW must be the same.



Caution The remote CE ID must be specified to establish the Kompella VPWS.

❖ Ethernet sub-interface access

The interface that connects PE with CE is encapsulated by the 802.1Q link protocol and provides the VPWS service. CE is connected to PE through the Ethernet sub-interface and requests Etherframe transmitted transparently by PE. The Ethernet sub-interface access mode applies when several VPWS services for multiple users are transmitted on a physical access link. PE devices can match packets with VPWS services according to dot1q tags carried by the user packets, and provide the access port multiplier mode. To adopt the access mode, packets sent by CE to PE must carry vlan tags.

Enter the privileged mode and complete the following configuration procedures:

Command	Function
Qtech# configure terminal	Enter the global configuration mode.
Qtech (config)# interface <i>type ID</i>	Enter the sub-interface configuration mode.
Qtech (config-if- <i>type ID</i>)# encapsulation dot1Q <i>vlan-id</i>	Configure the Vlan ID to be encapsulated.
Qtech (config-if- <i>type ID</i>)# exit	Exit from the interface configuration mode.
Qtech (config)# l2 vfi <i>vfi_name</i> vpnid <i>vpn_id</i> point-to-point	Enter the vfi configuration mode.
Qtech (config-vfi)# rd <i>rd_value</i>	Define the RD value of the Kompella VPWS instance.
Qtech (config-vfi)# route-target { import export both } <i>rt_value</i>	Configure RT.
Qtech (config-vfi)# encapsulation mpls ethernetvlan	Configure the encapsulation method of VFI as ethernetvlan.
Qtech (config-vfi)# site-id <i>id</i> [site-range <i>size</i>]	Configure VFI's site information.
Qtech (config-vfi-site)# xconnect interface <i>type ID</i> remote-ce-id <i>id</i>	Connect the interface that binds VFI locally with the VFI's remote CEs.

Configure gigabitethernet 1/0.100 to provide the VPWS service of transmitting Etherframes transparently.

```
Qtech# configure terminal
Qtech(config)# interface gigabitethernet 1/0
Qtech(config if gigabitethernet 1/0)# ip ref
Qtech(config if gigabitethernet 1/0)# exit
Qtech(config)# interface gigabitethernet 1/0.100
Qtech(config if serial 1/0.100)# encapsulation dot1q 100
Qtech(config if serial 1/0.100)# exit
Qtech(config)# l2 vfi vfiA vpnid 1 point to point
Qtech(config vfi)# rd 2:2
Qtech(config vfi)# route target both 2:2
Qtech(config vfi)# encapsulation mpls ethernetvlan
Qtech(config vfi)# site id 1
Qtech(config vfi site)# xconnect interface gigabitethernet 1/0.100 remote ce id 2
```



Caution

In the sub-interface access mode, we recommend choosing **ethernetvlan** as the PW encapsulation mode and the encapsulation modes on two ends of a PW must be the same.



Caution

The **ip ref** command must be used to enable the fast-forwarding function on the master interface of the sub-interface.

2.2.1.10 Configuring Heterogeneous Medium Communication VPWS

When CEs on two ends of the same L2VPN feature different link types, L2VPN's feature of heterogeneous medium intercommunication will be needed. According to the suggestion of draft-kompella-ppvpn-l2vpn, to establish the L2VPN connection, the encapsulation type of the L2VPN interface of PEs is ip-interworking. Users' IP packets are transmitted on the MPLS network transparently. When the L2VPN's heterogeneous medium communication function is used, VPWS service interfaces of PEs on both ends must encapsulate ip-interworking; after PW connection is set up, process packets as follows:

1. After PE receives packets from CE and decapsulate the link layer, it will transmit the IP packets to the MPLS network;
 2. The IP packets will be transmitted transparently through the MPLS network to the peer PE;
 3. The peer PE will re-encapsulate the IP packets according its link layer protocol type and sends them to the CE connects to it;
 4. The link layer controlling packet (such PPP's IPCP) sent by CE will be processed by PE and will not be transmitted in the MPLS network;
 5. Non-IP packets (such as MPLS packets) will be discarded and will not enter the MPLS network.
- ❖ Among the Ethernet interfaces on PE, L2VPN interfaces that can be encapsulated in the ip-interworking mode include:
 1. Ethernet interface or sub-interface of the Ethernet type
 2. Ethernet interface or sub-interface of the GigabitEthernet type

Note the following points:

1. After being encapsulated as ip-interworking, the PE's Ethernet interface will only process ARP and IP packets received by the local CE and discard the others, including IPv6 packets;
 2. When PE receives IP packets from CE, the dynamic MAC will not be updated;
 3. If the VPWS import interface that encapsulates ip-interworking on PE receives CE's ARP request packets, no matter what the destination IP is, it will use the PE's MAC address to reply;
 4. Each Ethernet interface or sub-interface of PE can only be connected to one CE and cannot to multiple CEs or other devices through HUB or a layer-2 switch. Otherwise, PE's learned MAC address will be covered, obstructing the forwarding.
- ❖ If CE uses the PPP link protocol to access PE, pay attention to the following points:
 1. Unlike the negotiation that provides the homogeneous medium L2VPN PPP simulative line service, the negotiation of PPP is conducted between CE and PE, rather than CEs; the address of the negotiation between PE and CE will not generate the corresponding route.
 2. It supports PAP and CHAP authentication. The authentication method is the same as the ordinary situation;

3.It does not support IPHC compression;

4.It supports transparent transmission of IP packets from the local CE to the peer CE. However, it does not support transparent transmission though protocols such as MPLS and IPv6.



Note If both ends of the CR is configured with the same network segment's address, they can be connected no matter which IP address is configured for the PE-end PPP proxy as CE has a network segment route that needs to the peer CE and the next-hop output interface can be obtained.



Note If two ends of CE are configured with different network segments' addresses, the PE-end PPP proxy must be specified as the peer CE address and a route that leads to the peer CE's network segment must be configured statically in CE.

Configure the heterogeneous medium communication VPWS access service, enter the privileged mode, and complete the following procedures:

Command	Function
Qtech# configure terminal	Enter the global configuration mode.
Qtech (config)# I2 vfi <i>vpws-name</i> vpnid <i>vpn-id</i> point-to-point	Create the Kompella VPWS instance and enter the VPWS configuration mode.
Qtech (config-vfi)# rd <i>rd_value</i>	First configure RD and configure RD value.
Qtech (config-vfi)# encapsulation mpls ip-interworking	Specify ip-interworking as Kompella L2VPN PW's encapsulation type.
Qtech (config-vfi)# route-target { import export both } <i>rt_value</i>	Configure RTs. Multiple RTs can be configured.
Qtech (config-vfi-site)# xconnect interface <i>interface-type</i> <i>interface-number</i> remote-ce-id <i>id</i>	Configure the local interface to be bound and specify the ID of CE to be connected remotely.
Qtech (config-vfi-site)# exit-site-mode	Return to VFI configuration mode.
Qtech (config-vfi)# exit	Return to global configuration mode.
Qtech (config)# interface <i>type ID</i>	Enter the interface configuration mode.
Qtech (config-if-type <i>ID</i>)# ip ref	<input checked="" type="checkbox"/> For routers, the fast-forwarding function of the interface must be enabled. Switches do not need to use this command.
Qtech (config-if-type <i>ID</i>)# show running-config	Display existing configuration.

Configure serial 1/0 to provide the heterogeneous medium VPWS service of the PPP access mode.

```
Qtech(config)# interface serial 1/0
Qtech(config if serial 1/0)# encapsulation ppp
```

For routers, the fast-forwarding function of the interface must be enabled. Switches do not need to use this command.

```
Qtech(config-if serial 1/0)# ip ref
Qtech(config-if serial 1/0)# exit

Qtech# configure terminal
Qtech# l2 vfi vpws1 vpid 1 point-to-point
Qtech(config-vfi)# rd 100:1
Qtech(config-vfi)# encapsulation mpls ip interworking
Qtech(config-vfi)# route-target both 100:1
Qtech(config-vfi)# site-id 1
Qtech(config-vfi-site)# xconnect interface serial 1/0 remote ce id 2
```

2.2.1.11 Configuring Inter-AS VPWS

In real application, multiple sites of a user's VPN may be connected to multiple service providers using different ASs, or multiple ASs of a service provider. The application mode in which VPN crosses multiple ASs is called Inter-AS VPN. There are two solutions for configuring Inter-AS VPWS:

- ❖ Inter-AS Option A: This solution is simple and can be adopted when the number of L2VPNs on ASBR is small.
- ❖ Inter-AS Option C: No VC is needed to be created or maintained on ASBR. When each AS has numerous cross-L2VPNs, this solution can be applied to solve the bottleneck of the ASBR's scalability.

Option A

Figure 1-6 Option A Inter-AS VPWS

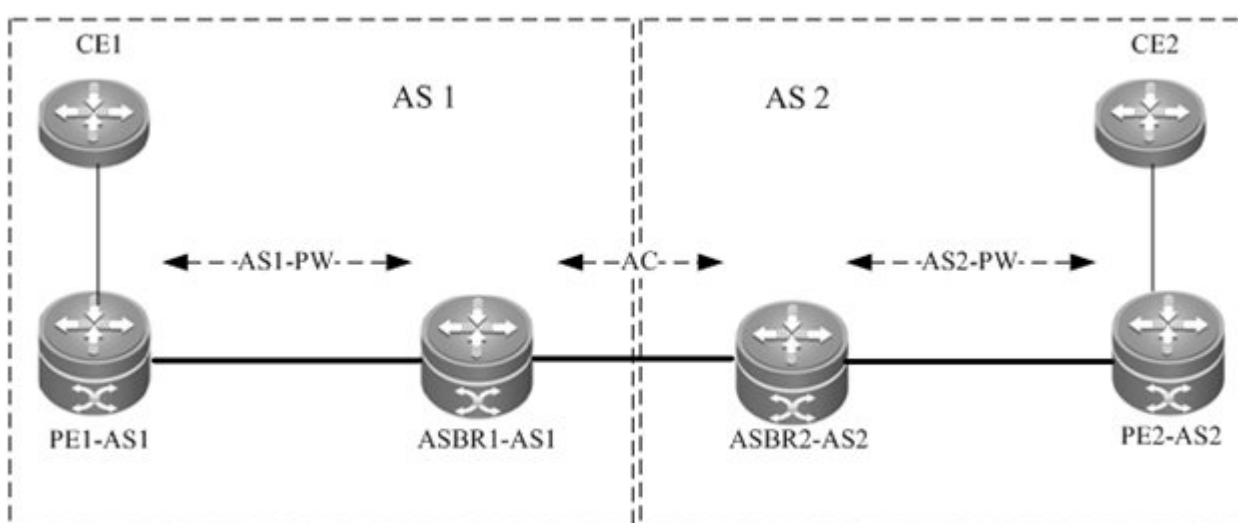

In the solution, ASBRs of two ASs are connected with each other and PEs of their respective autonomous systems. Each ASBR considers the peer ASBR as its CE device. As shown in the above figure, for ASBR1-AS1 of AS1, ASBR2-AS2 of AS2 is only its CE device; for ASBR2-AS2, ASBR1-AS1 is also only an imported CE device.

Option A is easy to realize. Two PE that serve as ASBRs do not need to be configured especially and the interface between ASBRs does not need an IP address. The shortcoming of the solution is that for each Inter-AS L2VPN or each Inter-AS PW, a link must be allocated between ASBRs of two ASs. The link can be logical or physical. When there are numerous Inter-AS PWs, they will cause great pressure to ASBRs and hinder the expansion.

The solution's configuration is similar with the above-mentioned basic VPWS configuration.

Option C

Figure 1-7 Option C Inter-AS VPWS

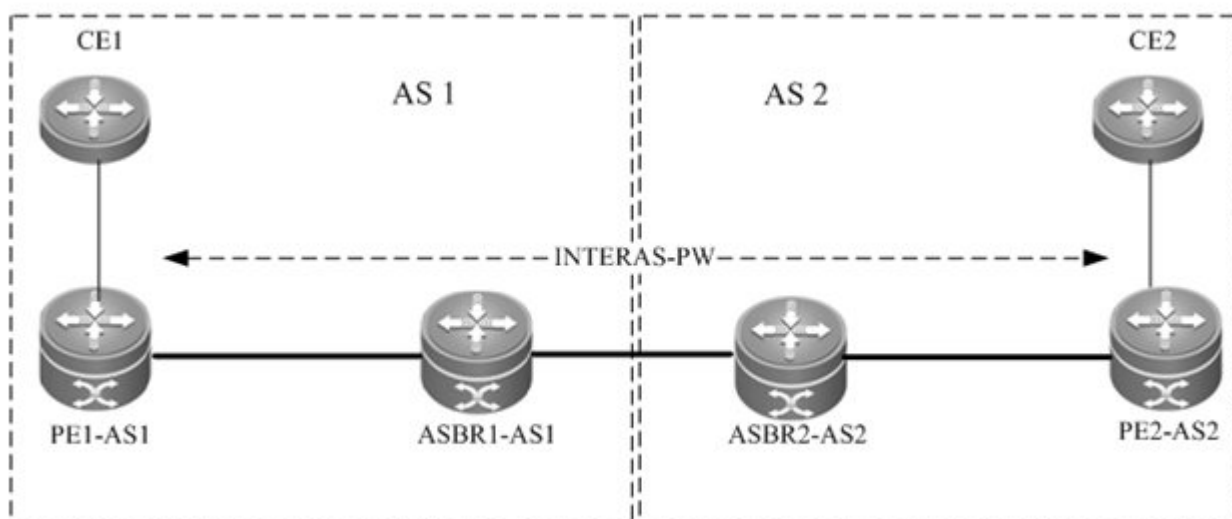

As shown in the above figure, Option C is to set up an Inter-AS PW on two ASs directly and switch PW labels. The principle is described as follows:

By sending tag IPv4 routes to PE in respective ASs and sending tag IPv4 routes received by PEs in respective ASs to the ASBR peers of peer ASs, ASBRs connect the tunnel between two ASs and set up a LSP tunnel between the ingress PE and egress PE; then, the Inter-AS LDP remote session will be set up between PEs in different ASs and PW information can be switched.

In the solution, ASBRs do not need to maintain Inter-AS L2VPN information or prepare a physical or logical interface for the Inter-AS L2VPN. But it needs to provide a MPLS tunnel. The L2VPN information is directly switched between PEs. Therefore the pressure on ASBRs is decreased, boosting the scalability.

The configuration process is described as follows:

- ❖ Configuring MPLS signaling
- ❖ Configuring PEs
- ❖ Configure ASBR
- ❖ Configuring the L2VPN address family
- ❖ Configuring a Kompella VPWS instance.
- ❖ Configuring the user access VPWS
- ❖ Checking the configuration result

Configuring MPLS signaling

In each AS, enable the MPLS and LDP functions on PE and P devices and the interface that connects to the P or PE device in AS of the ASBR to set up a basic MPLS network. See the chapter about basic MPLS configuration for the configuration procedures.

Configuring PEs

Configure the PEs in ASs, set up an IBGP session between PE and the AS, and switch IPv4 routes that carry tags.

Command	Function
Qtech# config terminal	Enter the global configuration mode.
Qtech (config)# router bgp <i>asn-number</i>	Configure BGP protocol and enter the BGP configuration mode.
Qtech (config-router)# neighbor <i>asbr-address remote-as asbr-asn-number</i>	Set up IBGP session between PE and ASBR.
Qtech (config-router)# neighbor <i>asbr-address update-source interface-name</i>	Configure using the Loopback address as the source address of the BGP session set up between peers.
Qtech (config-router)# address-family ipv4	Enter the IPv4 address family.
Qtech (config-router-af)# neighbor <i>asbr-address send-label</i>	Enable IPv4 route tag switching.
Qtech (config-router-af)# show running-config	Display configuration information.

Set up the IBGP session with the ASBR device 10.10.10.2 and enable the IPv4 route tag switching capability.

```
Qtech# configure terminal
Qtech(config)# router bgp 1
Qtech(config router)# neighbor 10.10.10.2 remote as 1
Qtech(config router)# neighbor 10.10.10.2 update source loopback 0
Qtech(config router)# address family ipv4
Qtech(config router af)# neighbor 10.10.10.2 activate
Qtech(config router af)# neighbor 10.10.10.2 send label
Qtech(config router af)# exit
```

Configure ASBR

Configure ASBR to set up the IBGP session with the PE in the same AS and with the ASBR in the other AS. Enable the IPv4 route tag switching function on both sessions and enable MPLS globally. Configure the PE address to be transmitted to another ASBR on the ASBR.

Command	Function
Qtech# config terminal	Enter the global configuration mode.
Qtech (config)# mpls ip	Enable the device to support MPLS forwarding.  Caution This command is inapplicable for switch chip forwarding.
Qtech (config)# mpls router ldp	Enable LDP protocol globally.
Qtech (config-mpls-router)# ldp router-id interface loopback id force	Configure the IP address of the Loopback interface as Router ID.
Qtech (config-mpls-router)# advertise-labels for bgp-routes	Allocate labels for BGP protocol's route.
Qtech (config-mpls-router)# exit	Return to the config mode.
Qtech (config)# router bgp asn-number	Configure BGP protocol and enter the BGP configuration mode.
Qtech (config-router)# neighbor asbr-address remote-as asbr-asn-numbe	Configure setting up EBGP session with ASBR.
Qtech (config-router)# neighbor pe-address remote-as asn-number	Configure setting up EBGP session with PE.
Qtech (config-router)# neighbor pe-address update-source loopback id	Configure using the Loopack address as the source address of the BGP session set up between PE peer.
Qtech (config-router)# address-family ipv4	Enter the IPv4 address family.
Qtech (config-router-af)# network pe-address mask mask-value	(Optional) Use the network command to import the PE route received to BGP. The IGP protocol can be re-distributed to import the route
Qtech (config-router-af)# neighbor asbr-address send-label	Enable the IPv4 route label switching capability on the BGP set up with the ASBR in another autonomous domain.
Qtech (config-router-af)# neighbor pe-address send-label	Enable the IPv4 route label switching capability on the BGP set up with the PE in the same autonomous domain.
Qtech (config-router-af)# neighbor asbr-ip-address route-map name out	(Optional) Configure the route allocation strategy. Define route map rules (Routemap) to control allocation of routes to neighbors and control whether these routes carry labels when they are sent.
Qtech(config-router-af)# neighbor asbr-ip-address route-map name in	(Optional) Configure the route allocation policy. Define route map rules (Routemap) to control only routes that carry labels.

```
Qtech(config-router-af)# show running-config
```

Display configuration information.

In the following example, the configured ASBR sets up an EBGP session with the ASBR in another autonomous domain (30.30.30.2) and the label switching capability is enabled for IPv4 route; the IBG neighbor is created between the ASBR and the PE in the same autonomous domain (10.10.10.1) and the label switching capability is enabled for IPv4 route.

```
Qtech# configure terminal
Qtech(config)# mpls ip
Qtech(config)# mpls router ldp
Qtech(config mpls router)# ldp router id interface loopback 0 force
Qtech(config mpls router)# advertise labels for bgp routes
Qtech(config mpls router)# exit
Qtech(config)# router bgp 1
Qtech(config router)# neighbor 30.30.30.2 remote as 2
Qtech(config router)# address family ipv4
Qtech(config router af)# neighbor 30.30.30.2 activate
Qtech(config router af)# neighbor 30.30.30.2 send label
Qtech(config router af)# exit
Qtech(config router)# neighbor 10.10.10.1 remote as 1
Qtech(config router)# neighbor 10.10.10.1 update source loopback 0
Qtech(config router)# address family ipv4
Qtech(config router af)# neighbor 10.10.10.1 send label
Qtech(config router af)# exit
```



Note

For the IBGP session set up between ASBR and the PE in the same AS, the **neighbor peer-address update-source loopback id** command must be used on the ASBR and PE to configure the address of the device's Loopback interface as the source address of the session. Otherwise, the Inter-AS LSP tunnel cannot be established.



Note

The direct EBGP session established between ASBRs usually use the direct connection interface's address as the source address of the BGP session to ensure that both ASBRs have routes that lead to each other. Therefore, we do not recommend using the **neighbor peer-address update-source loopback id** command on the EBGP session established based on direct connection to configure the address of the device's Loopback interface as the source address of the session. If necessary, use the **neighbor ebgp-multihop** command to enable the multi-hop EBGP function. Configure the static route on ASBR to ensure that the route can lead to the peer. Configure the static FTN to ensure that the cross-domain LSP's tunnel is through.



Note

The **label-switching** command must be used on the interface that connects two ASBRs to enable the interface's MPLS packet forwarding.

Configuring the L2VPN address family

Configure L2VPN address families between PEs of autonomous domains. See the Configuring L2VPN Address Family chapter for detailed configuration.

Configuring a Kompella VPWS instance

Configure L2VPN address families between PEs of autonomous domains. See the Configuring Kompella VPWS Instance chapter for detailed configuration.

Configuring the user access VPWS

See the Configuring User Access VPWS chapter for the detailed configuration.

Checking the configuration result

Command	Function
<code>show bgp ipv4 unicast labels</code>	Display label information allocated by BGP for IPv4 route.
<code>show bgp l2vpn vpws all connections</code>	Display Kompella VPWS connection information.
<code>show mpls l2transport vc [detail]</code>	Display VC status information.

Display route and label information on ASBR or PE.

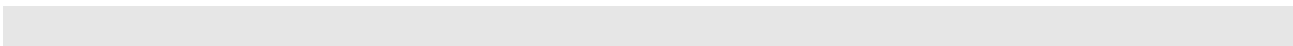

```
Qtech # show bgp ipv4 unicast labels
```

Network	Next Hop	In Label/Out Label
1.1.1.1/32	192.167.1.1	17/18
1.1.1.2/32	192.167.1.1	nolabel/19

Field	Definition
Network	Route prefix
Nexthop	Route's next-hop
In Label	Label (if any) allocated by the router
Out Label	Label (if any) learned from the next-hop router of the route

Display VC status information.

```
Qtech # show mpls l2transport vc detail
```

```
Local interface : VLAN 2, AC state: up  
Peer address: 192.168.0.1 ,VC ID: 2, VC status: up  
VC type: vlan      VC mode:tagged  
Group id: 0      MTU: 1500  
Control Word not support  
Output interface: VLAN 300 , imposed label stack {22 ,501 }  
MPLS VC label: local 22, remote 22
```

Field	Definition
Local interface	Local interface bound by VC
AC state	AC status, up or down
Peer address	VC's peer IP address
VC ID	VC's unique identifier
VC status	VC status, up or down
VC type	VC type
VC mode	VC mode, tagged or raw (only applies to the Ethernet access mode)
Group id	VC's local group ID
MTU	MTU of locally-configured VC
Control Word	Whether control word is supported
Output interface	Output interface on the public network used to transmit the VC process
imposed label stack	Added label stack
MPLS VC label	Local and peer private labels bound for the VC

2.2.1.12 Other Parameters for Configuring Kompella VPWS

Configuring VPWS Instance Descriptors (optional)

Users can configure the descriptive information of each VPWS instance.

Command	Function
Qtech# config terminal	Enter the global configuration mode.
Qtech (config)# I2 vfi <i>vfi-name</i>	Enter the VFI configuration mode.
Qtech (config-vfi)# description <i>vfi-description</i>	(Optional) Configure VFI's descriptive information.
Qtech (config-vfi)# end	Return to the privileged mode.
Qtech# copy running-config startup-config	Save configuration.

Configuring VPWS's compatibility (optional)

By default, the PW MTU value provided by L2VPN is 1,500 bytes. If the same PW's MTUs on two PEs are different, PW connection cannot be set up between the two PEs. Some producers' devices do not support configuring MTU in L2VPN instances. When such devices perform Kompella communication with devices of other producers, the **ignore match I2-extcommunity** command can be used to ignore received MTU and matching detection of EncapsType and Control Flag, thus ensuring the VC link is UP.

Command	Function
Qtech# config terminal	Enter the global configuration mode.
Qtech (config)# I2 vfi <i>vpls-name vpnid vpn-id</i> autodiscovery	Create the Kompella VPWS instance and enter the VPWS configuration mode.
Qtech (config-vfi)# ingore match I2-extcommunity	Configure ignoring detection of L2VPN expanded community attribute members.
Qtech# copy running-config startup-config	Save configuration.



Caution This command only takes effect on Kompella L2VPN.

Configuring MTU of VPWS instance (optional)

Users can configure each VFI instance's MTU value, which is 1500 by default. The MTU value of VFI indicates the length of packet that can be transmitted by PW, or the length of the user's layer-2 packet plus the length of PW-encapsulated packet. By default, if PW does not enable the control word, assuming that two labels are encapsulated, the length of an Ethernet packet that can be transmitted is 1,492 bytes, of which 8 bytes are encapsulated by PW (2 labels).

Command	Function
Qtech# config terminal	Enter the global configuration mode.
Qtech (config)# I2 vfi <i>name</i>	Enter the VFI configuration mode.
Qtech (config-vfi)# mtu <i>mtu</i>	(Optional) Configure VFI's MTU value.
Qtech (config-vfi)# end	Return to the privileged mode.
Qtech# copy running-config startup-config	Save configuration.



Caution Mtus of one VFI instance on different PEs must be configured the same. Otherwise, the signaling protocol cannot establish PW.



Caution If the PW signaling protocol negotiation's MTU is modified, the MTU of the user access service interface must be adjusted (generally adjusted to the length of PW MTU minus the encapsulated length); the PW's public-network-end output interface's MTU, MPLS MTU and PW MTU must be the same to ensure proper forwarding. The **mtu** command can be used on an interface to modify the interface's MTU. Use the **mpls mtu** command to modify the interface's MPLS MTU.

Configuring in and out Labels for the Static PW

The procedure for configuring labels is as follows:

Command	Function
Qtech# config terminal	Enter the global configuration mode.
Qtech (config)# mpls static-l2vc <i>ip-address</i> <i>vc-id out-label out-label-value in-label</i> <i>in-label-value</i>	Configure in and out labels for the static PW.
Qtech (config)# show running-config	Display all configuration information.

Verification

Command	Function
show bgp l2vpn vpws all	Display NLRI information about all Kompella VPWS instances.
show bgp l2vpn vpws all connections	Display Kompella VPWS signaling information.
show mpls l2transport vc [<i>vc_id</i> [<i>ip-address</i>]] [interface <i>interface_name</i>] [detail]	Display VC information established by VPWS.
show mpls vfi [<i>name</i>]	Display VFI instance information of Kompella VPWS.
show mpls ldp vc	Display VC signaling information of Martini VPWS.

MartiniVPWS Switch Configuration Instance

2.2.1.13 Applying access mode between CEs and PEs, configuring PW to work in the Ethernet mode

As shown in the following network topology, the interface that connects PEs and CEs works in the access mode, which means CEs are connected to PEs through the access link. PEs set up the PW service for the VLAN where the access port is located. Working in the Raw mode, frames transmitted by the PW set up between PE1 and PE2 do not carry vlan tag 10.

Figure 1-8

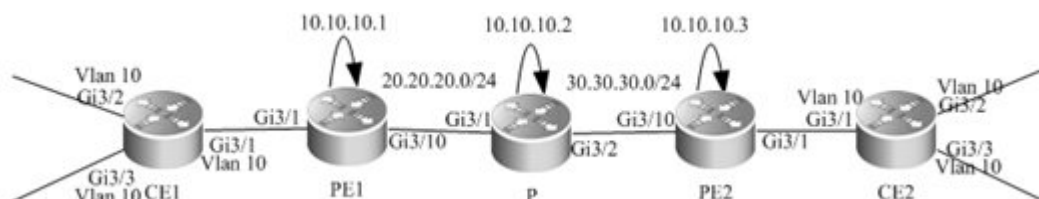

The configuration process is described as follows:

Configuring CE1:

Configure access port.

```
Qtech# configure terminal
Qtech(config)# interface gigabitethernet 3/2
Qtech(config if Gigabitethernet 3/2)# switchport mode access
Qtech(config if Gigabitethernet 3/2)# switchport access vlan 10
Qtech(config if Gigabitethernet 3/2)# exit
Qtech(config)# interface gigabitethernet 3/3
Qtech(config if Gigabitethernet 3/3)# switchport mode access
Qtech(config if Gigabitethernet 3/3)# switchport access vlan 10
Qtech(config if Gigabitethernet 3/3)# end
```

Configure the access access mode on CEs and between PEs.

```
Qtech(config)# interface gigabitethernet 3/1
Qtech(config if Gigabitethernet 3/1)# switchport mode access
Qtech(config if Gigabitethernet 3/1)# switchport access vlan 10
Qtech(config if Gigabitethernet 3/1)# end
```

Configuring PE1:

Configure Loopback interface.

```
Qtech# configure terminal
Qtech(config)# interface loopback 0
```

```
Qtech(config if Loopback 0)# ip address 10.10.10.1 255.255.255.255
```

Configure the public network LSP tunnel and remote LDP neighbor.

```
Qtech(config)# mpls ip
Qtech(config)# mpls router ldp
Qtech(config mpls router)# ldp router id interface loopback 0 force
Qtech(config mpls router)# neighbor 10.10.10.3
Qtech(config mpls router)# exit
Qtech(config)# interface gigabitethernet 3/10
```

The `no switchport` command is used to switch the port mode on switches to the Routed Port mode. It does not apply to routers and does not need to be used on routers.

```
Qtech(config if Gigabitethernet 3/10)# no switchport
Qtech(config if Gigabitethernet 3/10)# ip address 20.20.20.1 255.255.255.0
Qtech(config if Gigabitethernet 3/10)# mpls ip
Qtech(config if Gigabitethernet 3/10)# label switching
Qtech(config if Gigabitethernet 3/10)# exit
Qtech(config)# router ospf 10
Qtech(config router)# network 20.20.20.0 0.0.0.255 area 0
Qtech(config router)# network 10.10.10.1 0.0.0.0 area 0
Qtech(config router)# end
```

Configure the access mode between PEs and CEs.

```
Qtech# configure terminal
Qtech(config)# interface gigabitethernet 3/1
Qtech(config if Gigabitethernet 3/1)# switchport mode access
Qtech(config if Gigabitethernet 3/1)# switchport access vlan 10
Qtech(config if Gigabitethernet 3/1)# exit
```

Configure the PW service for Vlan 10 on PEs.

```
Qtech# configure terminal
Qtech(config)# interface vlan 10
Qtech(config if vlan 10)# xconnect 10.10.10.3 2 encapsulation mpls ethernet raw
Qtech(config if vlan 10)# exit
```

Configuring P:

Configure the public network route protocol and LSP tunnel.

The configuration process is similar with the fore-mentioned MPLS basic function configuration instance.

Configuring PE2:

It is similar with PE. See the configuration of PE1.

Configuring CE2:

It is similar with CE1. See the configuration of CE1.

2.2.1.14 Applying trunk access mode between CEs and PEs, configuring PW to work in the ethernetvlan mode

The network topology is shown in the following figure. CE1 and CE2 have two VLANs respectively. CEs are connected to PEs through Trunk. PEs have to set up a PW for each user's VLAN. In the application mode, multiple VLAN interfaces share one physical port. PE1 and PE2 established two PWs for VLAN10 and VLAN20 respectively to transmit frames carrying VLAN Tag 10 and Vlan tag 20.

Figure 1-9

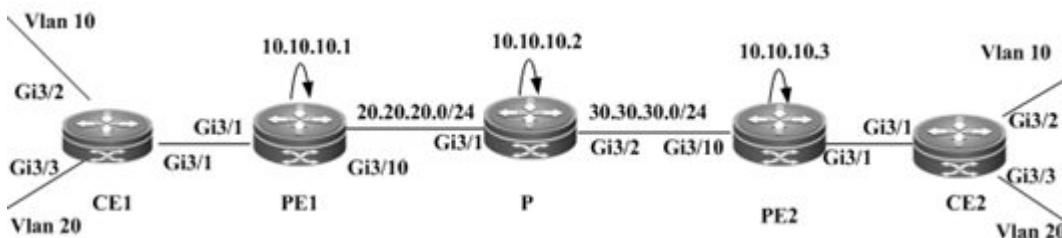

Configuration Steps:

Configuring CE1:

Configure access port.

```
Qtech# configure terminal
Qtech(config)# interface gigabitethernet 3/2
Qtech(config-if Gigabitethernet 3/2)# switchport mode access
Qtech(config-if Gigabitethernet 3/2)# switchport access vlan 10
Qtech(config-if Gigabitethernet 3/2)# exit
Qtech(config)# interface gigabitethernet 3/3
Qtech(config-if Gigabitethernet 3/3)# switchport mode access
Qtech(config-if Gigabitethernet 3/3)# switchport access vlan 20
Qtech(config-if Gigabitethernet 3/3)# end
```

Configure the trunk interface on CEs for connection with PEs.

```
Qtech(config)# interface gigabitethernet 3/1
Qtech(config-if Gigabitethernet 3/1)# switchport mode trunk
Qtech(config-if Gigabitethernet 3/1)# switchport trunk allow vlan add 10, 20
Qtech(config-if Gigabitethernet 3/1)# end
```

Configuring PE1:

Configure Loopback interface.

```
Qtech# configure terminal
Qtech(config)# interface loopback 0
Qtech(config if Loopback 0)# ip address 10.10.10.1 255.255.255.255
```

Configure the public network LSP tunnel and remote LDP neighbor.

The configuration is similar with that for applying the access access mode between CEs and PEs.

Configure the trunk interface on PEs for connection with CEs.

```
Qtech(config)# interface gigabitethernet 3/1
Qtech(config if Gigabitethernet 3/1)# switchport mode trunk
Qtech(config if Gigabitethernet 3/1)# end
```

Establish the PW service for VLAN 10 and VLAN 20 on PEs.

```
Qtech# configure terminal
Qtech(config)# interface vlan 10
Qtech(config if vlan 10)# xconnect 10.10.10.3 1 encapsulation mpls ethernetvlan tagged
Qtech(config if vlan 10)# exit
Qtech(config)# interface vlan 20
Qtech(config if vlan 20)# xconnect 10.10.10.3 2 encapsulation mpls ethernetvlan tagged
Qtech(config if vlan 20)# exit
```

Configuring P:

Configure the public network's LSP tunnel.

The configuration is similar with that for applying the access access mode between CEs and PEs.

Configuring PE2:

The configuration is similar with that of PE1. See the configuration of PE1.

CE2

The configuration is similar with that of CE1. See the configuration of CE1.

2.2.1.15 Applying dot1q tunnel access mode between CEs and PEs, configuring PW to work in the Ethernet mode

The network topology is shown in the following figure. The PW service is provided for a physical interface on PEs so that CEs can connect to PEs through the dot1q tunnel and the PW service can be enabled on the VLAN interface where the tunnel is located. Therefore, the VLAN Tag carried by user's frames will be transmitted transparently. Working in the Raw mode, the PW set up between PE1 and PE2 transmits frames with layer-1 VLAN tags, which are VLAN tags carried by frames received on CEs.

Figure 1-10

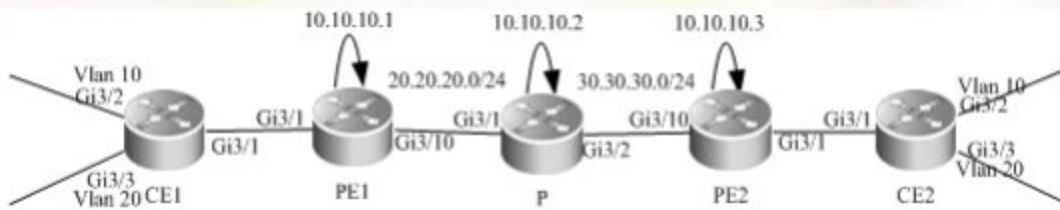

The configuration process is described as follows:

Configuring CE1:

Configure access port.

```
Qtech# configure terminal
Qtech(config)# interface gigabitethernet 3/2
Qtech(config-if-Gigabitethernet 3/2)# switchport mode access
Qtech(config-if-Gigabitethernet 3/2)# switchport access vlan 10
Qtech(config-if-Gigabitethernet 3/2)# exit
Qtech(config)# interface gigabitethernet 3/3
Qtech(config-if-Gigabitethernet 3/3)# switchport mode access
Qtech(config-if-Gigabitethernet 3/3)# switchport access vlan 20
Qtech(config-if-Gigabitethernet 3/3)# end
```

Configure the trunk interface on CEs for connection with PEs.

```
Qtech(config)# interface gigabitethernet 3/1
Qtech(config-if-Gigabitethernet 3/1)# switchport mode trunk
Qtech(config-if-Gigabitethernet 3/1)# switchport trunk allow vlan add 10, 20
Qtech(config-if-Gigabitethernet 3/1)# end
```

Configuring PE1:

Configure Loopback interface.

```
Qtech# configure terminal
Qtech(config)# interface loopback 0
Qtech(config-if-Loopback 0)# ip address 10.10.10.1 255.255.255.255
```

Configure the public network LSP tunnel and remote LDP neighbor.

The configuration is similar with that for applying the access access mode between CEs and PEs.

#Configure PEs to connect with CEs through dot1q.

```
Qtech(config)# interface gigabitethernet 3/1
Qtech(config-if-Gigabitethernet 3/1)# switchport access vlan 2
Qtech(config-if-Gigabitethernet 3/1)# switchport mode dot1q-tunnel
```

Configure the PW service for vlan2 on PEs.

```
Qtech(config)# interface vlan 2
```

```
Qtech(config if Vlan 2)# xconnect 10.10.10.3 2 encapsulation mpls ethernet raw
Qtech(config if Vlan 2)# end
```

Configuring P:

The configuration is similar with that for applying the access access mode between CEs and PEs.

Configuring PE2:

The configuration is similar with PE1.

CE2

The configuration is similar with CE1.

2.2.1.16 Option C Inter-AS VPWS

Figure 1-11 Option C: Inter-AS VPWS



The above figure shows how to realize Inter-AS VPWS through the Option C solution. To set up a PW between PEs of different domains, PW information is not maintained on ASBR and OSPF is used in each AS as IGP to realize inter-AS communication. Assuming CE1 is connected to PE through the access port, it is required to establish L2VPN communication between CE1 and CE2. Configuration of devices is described as follows (only configuration related to the function is included)



Note If CE1 and CE2 are connected to PEs through other modes such as Trunk mode, you only need to adjust the configuration of L2VPN in the VLAN interface mode (see configuration instances of various access modes for L2VPN). The configuration BGP and public network's IGP and MPLS does not need to be modified.

Configuring CE1

```
Qtech# configure terminal
Qtech(config)# interface FastEthernet 0/1
```

The **no switchport** command is used to switch the port mode on switches to the Routed Port mode. It does not apply to routers and does not need to be used on routers.

```
Qtech(config if FastEthernet 0/1)# no switchport
Qtech(config if FastEthernet 0/1)# ip address 192.168.1.1 255.255.255.0
```

```
Qtech(config if FastEthernet 0/1)# end
```

Similar with configuration of CE2

Configuring PE1-AS1

Configure the public network route protocol and MPLS signaling, and configure remote neighbors.

```
Qtech# configure terminal
Qtech(config)# interface loopback 0
Qtech(config if Loopback 0)# ip address 1.1.1.1 255.255.255.255
Qtech(config if Loopback 0)# exit
Qtech(config)# mpls ip
Qtech(config)# mpls router ldp
Qtech(config mpls router)# ldp router id interface loopback 0 force
Qtech(config mpls router)# neighbor 1.1.1.4
Qtech(config mpls router)# exit
Qtech(config)# router ospf 1
Qtech(config router)# network 10.0.0.0 0.0.0.255 area 0
Qtech(config router)# network 1.1.1.1 0.0.0.0 area 0
Qtech(config router)# exit
Qtech(config)# interface GigabitEthernet 0/1
```

The **no switchport** command is used to switch the port mode on switches to the Routed Port mode. It does not apply to routers and does not need to be used on routers.

```
Qtech(config if GigabitEthernet 0/1)# no switchport
Qtech(config if GigabitEthernet 0/1)# ip address 10.0.0.1 255.255.255.0
Qtech(config if GigabitEthernet 0/1)# mpls ip
Qtech(config if GigabitEthernet 0/1)# label switching
Qtech(config if GigabitEthernet 0/1)# end
```

Configure BGP protocol.

```
Qtech# configure terminal
Qtech(config)# router bgp 1
Qtech(config router)# neighbor 1.1.1.2 remote as 1
Qtech(config router)# neighbor 1.1.1.2 update source loopback 0
Qtech(config router)# address family ipv4
Qtech(config router af)# neighbor 1.1.1.2 activate
Qtech(config router af)# neighbor 1.1.1.2 send label
Qtech(config router af)# end
```

Configure the user access VPWS.

```
Qtech# configure terminal
Qtech(config)# interface GigabitEthernet 0/2
Qtech(config if GigabitEthernet 0/2)# switchport access vlan 2
```



```
Qtech(config if GigabitEthernet 0/2)# exit
Qtech(config)# interface vlan 2
Qtech(config if vlan 2)# xconnect 1.1.1.1 1 encapsulation mpls ethernet
Qtech(config if vlan 2)# end
```

Similar with configuration of PE2-AS2

Configuring ASBR1-AS1

Configure Loopback interface.

```
Qtech(config)# interface loopback 0
Qtech(config if Loopback 0)# ip address 1.1.1.2 255.255.255.255
Qtech(config if Loopback 0)# exit
```

Configure the public network route protocol and MPLS signaling.

```
Qtech# configure terminal
Qtech(config)# mpls ip
Qtech(config)# mpls router ldp
Qtech(config mpls router)# ldp router id interface loopback 0 force
Qtech(config mpls router)# exit
Qtech(config)# interface GigabitEthernet 0/1
```

The **no switchport** command is used to switch the port mode on switches to the Routed Port mode. It does not apply to routers and does not need to be used on routers.

```
Qtech(config if GigabitEthernet 0/1)# no switchport
Qtech(config if GigabitEthernet 0/1)# ip address 10.0.0.2 255.255.255.0
Qtech(config if GigabitEthernet 0/1)# mpls ip
Qtech(config if GigabitEthernet 0/1)# label switching
Qtech(config if GigabitEthernet 0/1)# exit
Qtech(config)# router ospf 1
Qtech(config router)# network 10.0.0.0 0.0.0.255 area 0
Qtech(config router)# network 1.1.1.2 0.0.0.0 area 0
Qtech(config router)# exit
```

Configure the IP address of the interface connected with ASBR2.

```
Qtech(config)# interface GigabitEthernet 0/2
```

The **no switchport** command is used to switch the port mode on switches to the Routed Port mode. It does not apply to routers and does not need to be used on routers.

```
Qtech(config if GigabitEthernet 0/2)# no switchport
Qtech(config if GigabitEthernet 0/2)# ip address 10.1.0.1 255.255.255.0
```

Enable the interface's label packet forwarding capability.

```
Qtech(config if GigabitEthernet 0/2)# label switching
Qtech(config if GigabitEthernet 0/2)# exit
```

Configure BGP protocol.

```

Qtech# configure terminal
Qtech(config)# router bgp 1
Qtech(config router)# neighbor 1.1.1.1 remote as 1
Qtech(config router)# neighbor 1.1.1.1 update source loopback 0
Qtech(config router)# neighbor 10.1.0.2 remote as 2
Qtech(config router)# address family ipv4
Qtech(config router af)# neighbor 1.1.1.1 activate
Qtech(config router af)# neighbor 1.1.1.1 send label
Qtech(config router af)# neighbor 10.1.0.2 activate
Qtech(config router af)# neighbor 10.1.0.2 send label
Qtech(config router af)# network 1.1.1.1 mask 255.255.255.255
Qtech(config router af)# end

```

The configuration of ASBR2-AS2 is similar with that of ASBR1-AS1.

The configuration of PE2-AS2 is similar with that of PE1-AS1.

The configuration of CE2 is similar with that of CE1.

MartiniVPWS Router Configuration Instance

2.2.1.17 Connecting CEs to PEs through Ethernet

As shown in the following network topology, the interface that connects PEs and CEs is an Ethernet interface, which means CEs are connected to PEs through the Ethernet interface, through which L2VPN service is provided between CE1 and CE2.

Figure 1-12

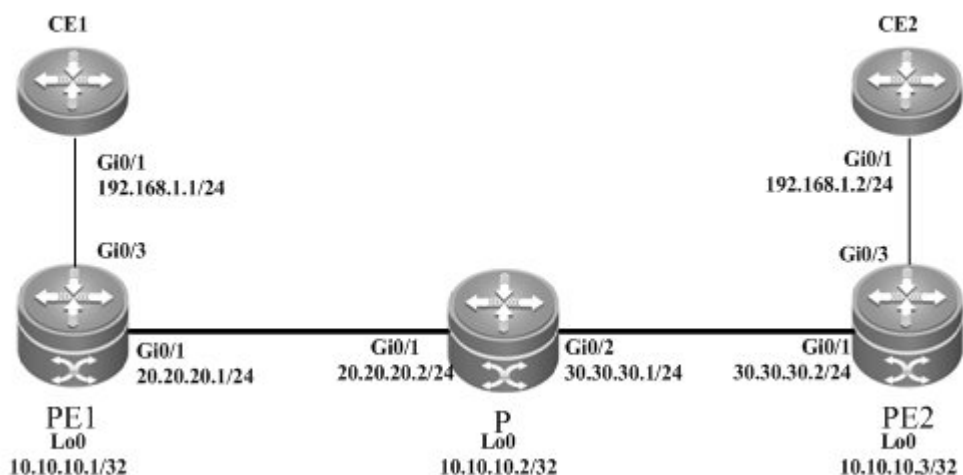

The configuration process is described as follows:

Configuring CE1:

Configure the interface that connects CE1 and PE2.

```
Qtech(config)# interface gigabitethernet 0/1
Qtech(config if Gigabitethernet 0/1)# ip address 192.168.1.1 255.255.255.0
```

For routers, the fast-forwarding function of routers must be enabled on the interface. Switches do not need to use this command.

```
Qtech(config if gigabitethernet 0/1)# ip ref
Qtech(config if Gigabitethernet 0/1)# end
```

Configuring PE1:

Configure Loopback interface.

```
Qtech# configure terminal
Qtech(config)# interface loopback 0
Qtech(config if Loopback 0)# ip address 10.10.10.1 255.255.255.255
```

Configure the public network LSP tunnel and remote LDP neighbor.

```
Qtech(config)# mpls ip
Qtech(config)# mpls router ldp
Qtech(config mpls router)# ldp router id interface loopback 0 force
Qtech(config mpls router)# neighbor 10.10.10.3
Qtech(config mpls router)# exit
Qtech(config)# interface gigabitethernet 0/1
Qtech(config if Gigabitethernet 0/1)# ip address 20.20.20.1 255.255.255.0
Qtech(config if Gigabitethernet 0/1)# mpls ip
```

For routers, the fast-forwarding function of routers must be enabled on the interface. Switches do not need to use this command.

```
Qtech(config if gigabitethernet 0/1)# ip ref
Qtech(config if Gigabitethernet 0/1)# exit
Qtech(config)# router ospf 10
Qtech(config router)# network 20.20.20.0 0.0.0.255 area 0
Qtech(config router)# network 10.10.10.1 0.0.0.0 area 0
Qtech(config router)# end
```

Configure the interface that connects PEs and CEs to enable the VPWS service.

```
Qtech# configure terminal
Qtech(config)# interface gigabitethernet 0/3
Qtech(config if Gigabitethernet 0/3)# xconnect 10.10.10.3 2 encapsulation mpls ethernet raw
Qtech(config if Gigabitethernet 0/3)# exit
```

Configuring P:

Configure the public network route protocol and LSP tunnel.

The configuration process is similar with the fore-mentioned MPLS basic function configuration instance.

Configuring PE2:

It is similar with PE. See the configuration of PE1.

Configuring CE2:

It is similar with CE1. See the configuration of CE1.

2.2.1.18 Connecting CEs to PEs through VLAN

As shown in the following network topology, the interface that connects PEs and CEs is an Ethernet sub-interface, which means CEs are connected to PEs through the Ethernet sub-interface, through which L2VPN service is provided between CE1 and CE2.

Figure 1-13

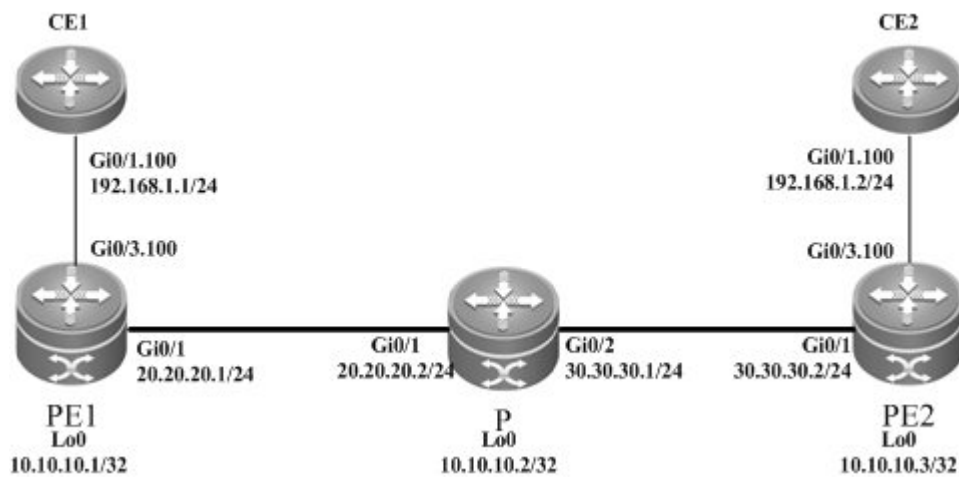

The configuration process is described as follows:

Configuring CE1:

Configure the interface that connects CE1 and PE2.

```
Qtech(config)# interface gigabitethernet 0/1
```

For routers, the fast-forwarding function of routers must be enabled on the interface. Switches do not need to use this command.

```
Qtech(config if gigabitethernet 0/1)# ip ref
```

```
Qtech(config if gigabitethernet 0/1)# exit
```

```
Qtech(config)# interface gigabitethernet 0/1.100
```

```
Qtech(config if Gigabitethernet 0/1.100)# encapsulation dot1Q 100
```

```
Qtech(config if Gigabitethernet 0/1.100)# ip address 192.168.1.1 255.255.255.0
```

```
Qtech(config if Gigabitethernet 0/1.100)# end
```

Configuring PE1:

Configure Loopback interface.

```
Qttech# configure terminal
Qttech(config)# interface loopback 0
Qttech(config if Loopback 0)# ip address 10.10.10.1 255.255.255.255
```

Configure the public network LSP tunnel and remote LDP neighbor.

```
Qttech(config)# mpls ip
Qttech(config)# mpls router ldp
Qttech(config mpls router)# ldp router id interface loopback 0 force
Qttech(config mpls router)# neighbor 10.10.10.3
Qttech(config mpls router)# exit
Qttech(config)# interface gigabitethernet 0/1
Qttech(config if Gigabitethernet 0/1)# ip address 20.20.20.1 255.255.255.0
Qttech(config if Gigabitethernet 0/1)# mpls ip
Qttech(config if Gigabitethernet 0/1)# label switching
```

For routers, the fast-forwarding function of routers must be enabled on the interface. Switches do not need to use this command.

```
Qttech(config if gigabitethernet 0/1)# ip ref
Qttech(config if Gigabitethernet 0/1)# exit
Qttech(config)# router ospf 10
Qttech(config router)# network 20.20.20.0 0.0.0.255 area 0
Qttech(config router)# network 10.10.10.1 0.0.0.0 area 0
Qttech(config router)# end
```

Configure the interface that connects PEs and CEs to enable the VPWS service.

```
Qttech# configure terminal
Qttech(config)# interface gigabitethernet 0/3
Qttech(config if Gigabitethernet 0/3)# ip ref
Qttech(config if Gigabitethernet 0/3)# exit
Qttech(config)# interface gigabitethernet 0/3.100
Qttech(config if Gigabitethernet 0/3.100)# encapsulation dot1Q 100
Qttech(config if Gigabitethernet 0/3.100)# xconnect 10.10.10.3 2 encapsulation mpls
ethernetvlan tagged
Qttech(config if Gigabitethernet 0/3.100)# exit
```

Configuring P:

Configure the public network route protocol and LSP tunnel.

The configuration process is similar with the fore-mentioned MPLS basic function configuration instance.

Configuring PE2:

It is similar with PE. See the configuration of PE1.

Configuring CE2:

It is similar with CE1. See the configuration of CE1.

2.2.1.19 Connecting CEs to PEs through PPP

As shown in the following network topology, the interface that connects PEs and CEs is a POS interface, which means the PPP link protocol is encapsulated and CEs are connected to PEs through PPP, through which L2VPN service is provided between CE1 and CE2.

Figure 1-14

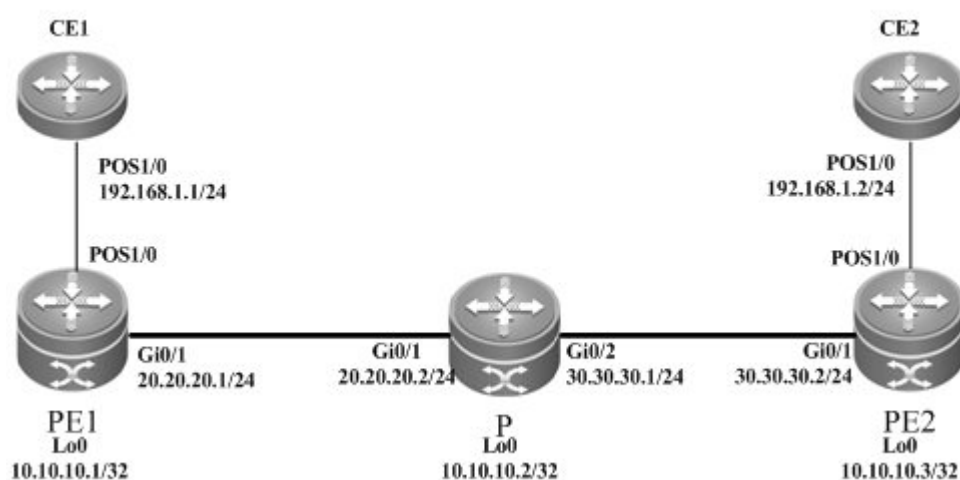

The configuration process is described as follows:

Configuring CE1:

Configure the interface that connects CE1 and PE2.

```
Qtech(config)# interface pos 1/0
Qtech(config if pos 1/0)# encapsulation ppp
Qtech(config if pos 1/0)# ip address 192.168.1.1 255.255.255.0
Qtech(config if pos 1/0)# clock internal
```

For routers, the fast-forwarding function of routers must be enabled on the interface. Switches do not need to use this command.

```
Qtech(config if pos 1/0)# ip ref
Qtech(config if pos 1/0)# end
```

Configuring PE1:

Configure Loopback interface.

```
Qtech# configure terminal
```

```
Qtech(config)# interface loopback 0
Qtech(config if Loopback 0)# ip address 10.10.10.1 255.255.255.255
```

Configure the public network LSP tunnel and remote LDP neighbor.

```
Qtech(config)# mpls ip
Qtech(config)# mpls router ldp
Qtech(config mpls router)# ldp router id interface loopback 0 force
Qtech(config mpls router)# neighbor 10.10.10.3
Qtech(config mpls router)# exit
Qtech(config)# interface gigabitethernet 0/1
Qtech(config if Gigabitethernet 0/1)# ip address 20.20.20.1 255.255.255.0
Qtech(config if Gigabitethernet 0/1)# mpls ip
Qtech(config if Gigabitethernet 0/1)# label switching
```

For routers, the fast-forwarding function of routers must be enabled on the interface. Switches do not need to use this command.

```
Qtech(config if gigabitethernet 0/1)# ip ref
Qtech(config if Gigabitethernet 0/1)# exit
Qtech(config)# router ospf 10
Qtech(config router)# network 20.20.20.0 0.0.0.255 area 0
Qtech(config router)# network 10.10.10.1 0.0.0.0 area 0
Qtech(config router)# end
```

Configuring P:

Configure the public network route protocol and LSP tunnel.

The configuration process is similar with the fore-mentioned MPLS basic function configuration instance.

Configuring PE2:

It is similar with PE. See the configuration of PE1.

Configuring CE2:

It is similar with CE1. See the configuration of CE1.

2.2.1.20 Connecting CEs to PEs through MultiPPP

As shown in the following network topology, PEs and CEs are connected through the Serial interface and the PPP protocol is encapsulated. PEs and CEs bind two Serial interfaces, which work in the MultiPPP mode. Therefore, CEs are connected to PEs through MultiPPP to establish the L2VPN service between CE1 and CE2.

CEs are connected to PEs through MultiPPP by enabling the heterogeneous medium access mode on the PE-end multilink interface. The mode does not support the homogeneous medium access mode.

Figure 1-15

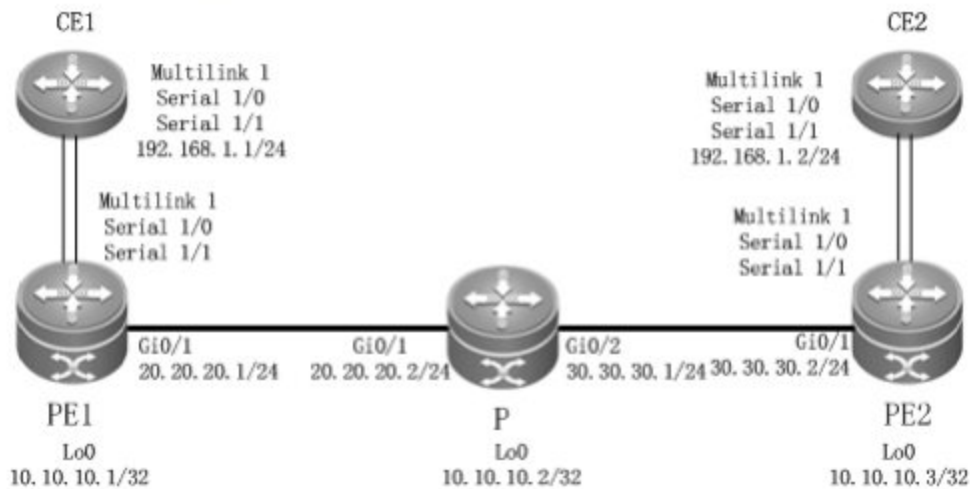

The configuration process is described as follows:

Configuring CE1:

Configure the multilink interface that connects CE1 and PE2.

```
Qtech(config)# interface multilink 1
Qtech(config-multilink 1)# ip address 192.168.1.1 255.255.255.0
```

For routers, the fast-forwarding function of routers must be enabled on the interface. Switches do not need to use this command.

```
Qtech(config-multilink 1)# ip ref
Qtech(config-multilink 1)# end
```

Configure the serial interface bound by the multilink interface.

```
Qtech(config)# interface serial 1/0
Qtech(config-serial 1/0)# encapsulation ppp
Qtech(config-serial 1/0)# ppp multilink
Qtech(config-serial 1/0)# ppp multilink group 1
Qtech(config-serial 1/0)# end
Qtech(config)# interface serial 1/1
Qtech(config-serial 1/1)# encapsulation ppp
Qtech(config-serial 1/1)# ppp multilink
Qtech(config-serial 1/1)# ppp multilink group 1
Qtech(config-serial 1/1)# end
```

Configuring PE1:

Configure Loopback interface.

```
Qtech# configure terminal
Qtech(config)# interface loopback 0
```



```
Qtech(config if Loopback 0)# ip address 10.10.10.1 255.255.255.255
```

Configure the public network LSP tunnel and remote LDP neighbor.

```
Qtech(config)# mpls ip
Qtech(config)# mpls router ldp
Qtech(config mpls router)# ldp router id interface loopback 0 force
Qtech(config mpls router)# neighbor 10.10.10.3
Qtech(config mpls router)# exit
Qtech(config)# interface gigabitethernet 0/1
Qtech(config if Gigabitethernet 0/1)# ip address 20.20.20.1 255.255.255.0
Qtech(config if Gigabitethernet 0/1)# mpls ip
Qtech(config if Gigabitethernet 0/1)# label switching
```

For routers, the fast-forwarding function of routers must be enabled on the interface. Switches do not need to use this command.

```
Qtech(config if gigabitethernet 0/1)# ip ref
Qtech(config if Gigabitethernet 0/1)# exit
Qtech(config)# router ospf 10
Qtech(config router)# network 20.20.20.0 0.0.0.255 area 0
Qtech(config router)# network 10.10.10.1 0.0.0.0 area 0
Qtech(config router)# end
```

Configure the interface that connects PEs and CEs to enable the VPWS service.

Configure the multilink interface.

```
Qtech(config)# interface multilink 1
Qtech(config multilink 1)# ip ref
Qtech(config multilink 1)# xconnect 10.10.10.3 2 encapsulation mpls ip interworking
```

Configure the serial interface bound by the multilink interface.

```
Qtech(config)# interface serial 1/0
Qtech(config serial 1/0)# encapsulation ppp
Qtech(config serial 1/0)# ppp multilink
Qtech(config serial 1/0)# ppp multilink group 1
Qtech(config serial 1/0)# end
Qtech(config)# interface serial 1/1
Qtech(config serial 1/1)# encapsulation ppp
Qtech(config serial 1/1)# ppp multilink
Qtech(config serial 1/1)# ppp multilink group 1
Qtech(config serial 1/1)# end
```

Configuring P:

Configure the public network route protocol and LSP tunnel.

The configuration process is similar with the fore-mentioned MPLS basic function configuration instance.

Configuring PE2:

It is similar with PE. See the configuration of PE1.

Configuring CE2:

It is similar with CE1. See the configuration of CE1.

2.2.1.21 Connecting CEs to PEs through HDLC

As shown in the following network topology, the interface that connects PEs and CEs is a POS interface and the HDLC link protocol is encapsulated, which means CEs are connected to PEs through a HDLC interface, through which L2VPN service is provided between CE1 and CE2.

Figure 1-16

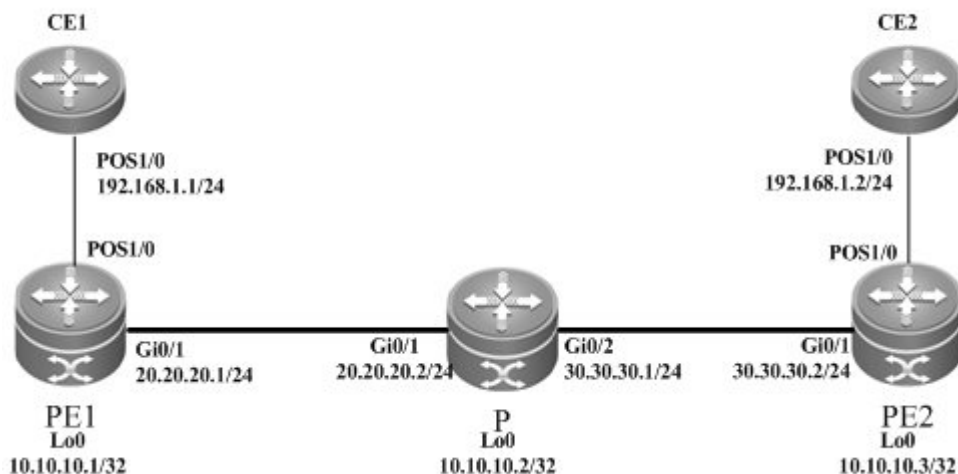

The configuration process is described as follows:

Configuring CE1:

Configure the interface that connects CE1 and PE2.

```
Qtech(config)# interface pos 1/0
Qtech(config if pos 1/0)# encapsulation hdlc
Qtech(config if pos 1/0)# ip address 192.168.1.1 255.255.255.0
Qtech(config if pos 1/0)# clock internal
```

For routers, the fast-forwarding function of routers must be enabled on the interface. Switches do not need to use this command.

```
Qtech(config if pos 1/0)# ip ref
Qtech(config if pos 1/0)# end
```

Configuring PE1:

Configure Loopback interface.

```
Qtech# configure terminal
Qtech(config)# interface loopback 0
Qtech(config if Loopback 0)# ip address 10.10.10.1 255.255.255.255
```

Configure the public network LSP tunnel and remote LDP neighbor.

```
Qtech(config)# mpls ip
Qtech(config)# mpls router ldp
Qtech(config mpls router)# ldp router id interface loopback 0 force
Qtech(config mpls router)# neighbor 10.10.10.3
Qtech(config mpls router)# exit
Qtech(config)# interface gigabitethernet 0/1
Qtech(config if Gigabitethernet 0/1)# ip address 20.20.20.1 255.255.255.0
Qtech(config if Gigabitethernet 0/1)# mpls ip
Qtech(config if Gigabitethernet 0/1)# label switching
```

For routers, the fast-forwarding function of routers must be enabled on the interface. Switches do not need to use this command.

```
Qtech(config if gigabitethernet 0/1)# ip ref
Qtech(config if Gigabitethernet 0/1)# exit
Qtech(config)# router ospf 10
Qtech(config router)# network 20.20.20.0 0.0.0.255 area 0
Qtech(config router)# network 10.10.10.1 0.0.0.0 area 0
Qtech(config router)# end
```

Configuring P:

Configure the public network route protocol and LSP tunnel.

The configuration process is similar with the fore-mentioned MPLS basic function configuration instance.

Configuring PE2:

It is similar with PE. See the configuration of PE1.

Configuring CE2:

It is similar with CE1. See the configuration of CE1.

2.2.1.22 VLAN and PPP Heterogeneous Medium Communication

As shown in the following network topology, the interface that connects PE1 and CE1 is an Ethernet sub-interface and the encapsulated link protocol is 802.1Q. PE2 and CE2 are connected by the POS interface and the encapsulated link protocol is PPP, through which the L2VPN service is

established between CE1 and CE2 and VPWS provides the heterogeneous medium communication L2VPN service.

Figure 1-17

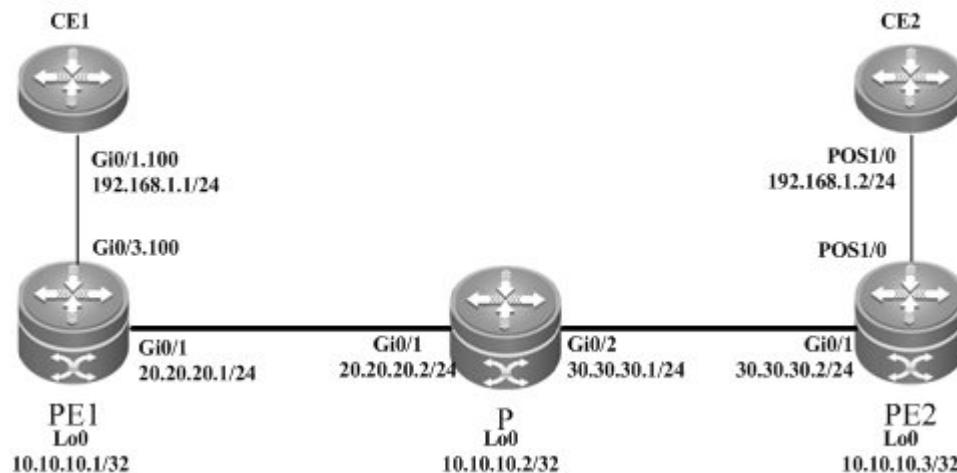

The configuration process is described as follows:

Configure the interface that connects CE1 and PE2.

```
Qtech(config)# interface gigabitethernet 0/1
```

For routers, the fast-forwarding function of routers must be enabled on the interface. Switches do not need to use this command.

```
Qtech(config if gigabitethernet 0/1)# ip ref
Qtech(config if gigabitethernet 0/1)# exit
Qtech(config)# interface gigabitethernet 0/1.100
Qtech(config if Gigabitethernet 0/1.100)# encapsulation dot1Q 100
Qtech(config if Gigabitethernet 0/1.100)# ip address 192.168.1.1 255.255.255.0
Qtech(config if Gigabitethernet 0/1.100)# end
```

Configuring PE1:

Configure Loopback interface.

```
Qtech# configure terminal
Qtech(config)# interface loopback 0
Qtech(config if Loopback 0)# ip address 10.10.10.1 255.255.255.255
```

Configure the public network LSP tunnel and remote LDP neighbor.

```
Qtech(config)# mpls ip
Qtech(config)# mpls router ldp
Qtech(config mpls router)# ldp router id interface loopback 0 force
Qtech(config mpls router)# neighbor 10.10.10.3
Qtech(config mpls router)# exit
```

```
Qtech(config)# interface gigabitethernet 0/1
Qtech(config if Gigabitethernet 0/1)# ip address 20.20.20.1 255.255.255.0
Qtech(config if Gigabitethernet 0/1)# mpls ip
Qtech(config if Gigabitethernet 0/1)# label switching
```

For routers, the fast-forwarding function of routers must be enabled on the interface. Switches do not need to use this command.

```
Qtech(config if gigabitethernet 0/1)# ip ref
Qtech(config if Gigabitethernet 0/1)# exit
Qtech(config)# router ospf 10
Qtech(config router)# network 20.20.20.0 0.0.0.255 area 0
Qtech(config router)# network 10.10.10.1 0.0.0.0 area 0
Qtech(config router)# end
```

Configure the interface that connects PEs and CEs to enable the VPWS service.

```
Qtech# configure terminal
Qtech(config)# interface gigabitethernet 0/3
Qtech(config if Gigabitethernet 0/3)# ip ref
Qtech(config if Gigabitethernet 0/3)# exit
Qtech(config)# interface gigabitethernet 0/3.100
Qtech(config if Gigabitethernet 0/3.100)# encapsulation dot1Q 100
Qtech(config if Gigabitethernet 0/3.100)# xconnect 10.10.10.3 2 encapsulation mpls
ip interworking
Qtech(config if Gigabitethernet 0/3.100)# exit
```

Configuring P:

Configure the public network route protocol and LSP tunnel.

The configuration process is similar with the fore-mentioned MPLS basic function configuration instance.

Configuring PE2:

Configure Loopback interface.

```
Qtech# configure terminal
Qtech(config)# interface loopback 0
Qtech(config if Loopback 0)# ip address 10.10.10.3 255.255.255.255
```

Configure the public network LSP tunnel and remote LDP neighbor.

```
Qtech(config)# mpls ip
Qtech(config)# mpls router ldp
Qtech(config mpls router)# ldp router id interface loopback 0 force
Qtech(config mpls router)# neighbor 10.10.10.1
Qtech(config mpls router)# exit
Qtech(config)# interface gigabitethernet 0/1
```

```
Qtech(config if GigabitEthernet 0/1)# ip address 30.30.30.2 255.255.255.0
Qtech(config if GigabitEthernet 0/1)# mpls ip
Qtech(config if GigabitEthernet 0/1)# label switching
```

For routers, the fast-forwarding function of routers must be enabled on the interface. Switches do not need to use this command.

```
Qtech(config if gigabitEthernet 0/1)# ip ref
Qtech(config if GigabitEthernet 0/1)# exit
Qtech(config)# router ospf 10
Qtech(config router)# network 30.30.30.0 0.0.0.255 area 0
Qtech(config router)# network 10.10.10.3 0.0.0.0 area 0
Qtech(config router)# end
```

Configure the interface that connects PEs and CEs to enable the VPWS service.

```
Qtech# configure terminal
Qtech(config)# interface pos 1/0
Qtech(config if pos1/0)# ip ref
Qtech(config if pos1/0)# encapsulation ppp
Qtech(config if pos1/0)# xconnect 10.10.10.3 2 encapsulation mpls ip interworking
Qtech(config if pos1/0)# exit
```

Configuring CE2:

```
Qtech(config)# interface pos 1/0
Qtech(config if pos 1/0)# ip ref
Qtech(config if pos 1/0)# encapsulation ppp
Qtech(config if pos 1/0)# ip address 192.168.1.2 255.255.255.0
Qtech(config if pos 1/0)# clock internal
Qtech(config if pos 1/0)# end
```

2.2.1.23 VLAN and MultiPPP Heterogeneous Medium Communication

As shown in the following network topology, the interface that connects PE1 and CE1 is an Ethernet sub-interface and the encapsulated link protocol is 802.1Q. PE2 and CE2 are connected by the Serial interface and the encapsulated link protocol is PPP, bound by two physical lines in the MultiPPP working mode, through which the L2VPN service is established between CE1 and CE2 and VPWS provides the heterogeneous medium communication L2VPN service.

Figure 1-18

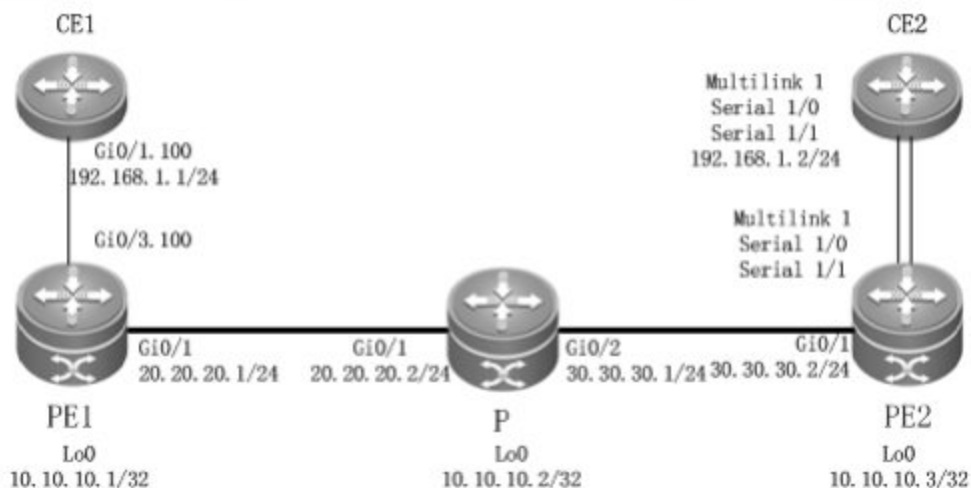

Configuration of CE1 and PE1 is generally same as the configuration of VLAN and PPP heterogeneous medium communication.

The configuration of CE2 and PE2 is generally same as the configuration of CE when it is connected to PE through MutilPPP.

2.2.1.24 VLAN and HDLC Heterogeneous Medium Communication

As shown in the following network topology, the interface that connects PE1 and CE1 is an Ethernet sub-interface and the encapsulated link protocol is 802.1Q. PE2 and CE2 are connected by the POS interface and the encapsulated link protocol is HDLC, through which the L2VPN service is established between CE1 and CE2 and VPWS provides the heterogeneous medium communication L2VPN service.



Figure 1-19

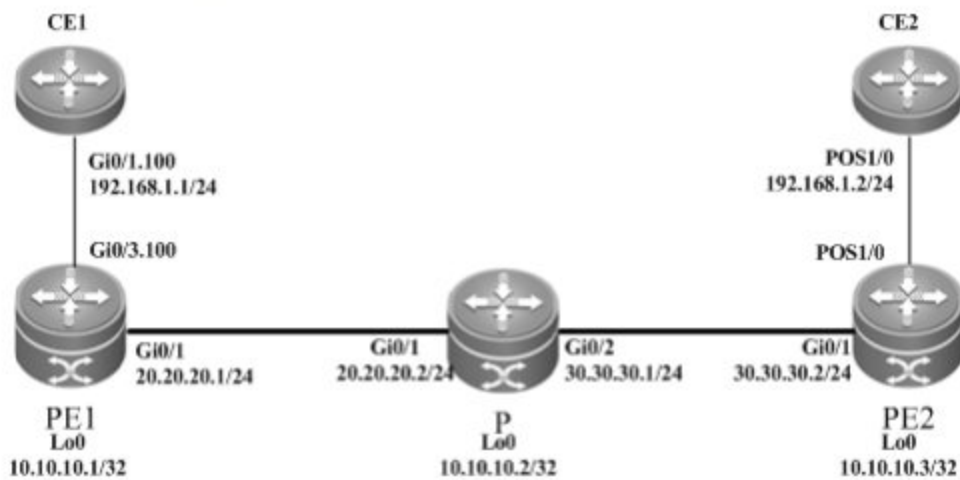

The configuration process is described as follows:

Configure the interface that connects CE1 and PE2.

```
Qtch(config)# interface gigabitethernet 0/1
```

For routers, the fast-forwarding function of routers must be enabled on the interface. Switches do not need to use this command.

```
Qtch(config-if-gigabitethernet 0/1)# ip ref
Qtch(config-if-gigabitethernet 0/1)# exit
Qtch(config)# interface gigabitethernet 0/1.100
Qtch(config-if-Gigabitethernet 0/1.100)# encapsulation dot1Q 100
Qtch(config-if-Gigabitethernet 0/1.100)# ip address 192.168.1.1 255.255.255.0
Qtch(config-if-Gigabitethernet 0/1.100)# end
```

Configuring PE1:

Configure Loopback interface.

```
Qtch# configure terminal
Qtch(config)# interface loopback 0
Qtch(config-if-Loopback 0)# ip address 10.10.10.1 255.255.255.255
```

Configure the public network LSP tunnel and remote LDP neighbor.

```
Qtch(config)# mpls ip
Qtch(config)# mpls router ldp
Qtch(config-mpls-router)# ldp router-id interface loopback 0 force
Qtch(config-mpls-router)# neighbor 10.10.10.3
Qtch(config-mpls-router)# exit
Qtch(config)# interface gigabitethernet 0/1
Qtch(config-if-Gigabitethernet 0/1)# ip address 20.20.20.1 255.255.255.0
```



```
Qtech(config if GigabitEthernet 0/1)# mpls ip
Qtech(config if GigabitEthernet 0/1)# label switching
```

For routers, the fast-forwarding function of routers must be enabled on the interface. Switches do not need to use this command.

```
Qtech(config if gigabitEthernet 0/1)# ip ref
Qtech(config if GigabitEthernet 0/1)# exit
Qtech(config)# router ospf 10
Qtech(config router)# network 20.20.20.0 0.0.0.255 area 0
Qtech(config router)# network 10.10.10.1 0.0.0.0 area 0
Qtech(config router)# end
```

Configure the interface that connects PEs and CEs to enable the VPWS service.

```
Qtech# configure terminal
Qtech(config)# interface gigabitEthernet 0/3
Qtech(config if GigabitEthernet 0/3)# ip ref
Qtech(config if GigabitEthernet 0/3)# exit
Qtech(config)# interface gigabitEthernet 0/3.100
Qtech(config if GigabitEthernet 0/3.100)# encapsulation dot1Q 100
Qtech(config if GigabitEthernet 0/3.100)# xconnect 10.10.10.3 2 encapsulation mpls
ip interworking
Qtech(config if GigabitEthernet 0/3.100)# exit
```

Configuring P:

Configure the public network route protocol and LSP tunnel.

The configuration process is similar with the fore-mentioned MPLS basic function configuration instance.

Configuring PE2:

Configure Loopback interface.

```
Qtech# configure terminal
Qtech(config)# interface loopback 0
Qtech(config if Loopback 0)# ip address 10.10.10.3 255.255.255.255
```

Configure the public network LSP tunnel and remote LDP neighbor.

```
Qtech(config)# mpls ip
Qtech(config)# mpls router ldp
Qtech(config mpls router)# ldp router id interface loopback 0 force
Qtech(config mpls router)# neighbor 10.10.10.1
Qtech(config mpls router)# exit
Qtech(config)# interface gigabitEthernet 0/1
Qtech(config if GigabitEthernet 0/1)# ip address 30.30.30.2 255.255.255.0
Qtech(config if GigabitEthernet 0/1)# mpls ip
```

```
Qtech(config if GigabitEthernet 0/1)# label switching
```

For routers, the fast-forwarding function of routers must be enabled on the interface. Switches do not need to use this command.

```
Qtech(config if gigabitEthernet 0/1)# ip ref
Qtech(config if GigabitEthernet 0/1)# exit
Qtech(config)# router ospf 10
Qtech(config router)# network 30.30.30.0 0.0.0.255 area 0
Qtech(config router)# network 10.10.10.3 0.0.0.0 area 0
Qtech(config router)# end
```

Configure the interface that connects PEs and CEs to enable the VPWS service.

```
Qtech# configure terminal
Qtech(config)# interface pos 1/0
Qtech(config if pos 1/0)# ip ref
Qtech(config if pos1/0)# encapsulation hdlc
Qtech(config if pos1/0)# xconnect 10.10.10.3 2 encapsulation mpls ip interworking
Qtech(config if pos1/0)# exit
```

Configuring CE2:

```
Qtech(config)# interface pos 1/0
Qtech(config if pos 1/0)# ip ref
Qtech(config if pos 1/0)# encapsulation hdlc
Qtech(config if pos 1/0)# ip address 192.168.1.2 255.255.255.0
Qtech(config if pos 1/0)# clock internal
Qtech(config if pos 1/0)# end
```

2.2.1.25 Ethernet and PPP Heterogeneous Medium Communication

As shown in the following network topology, the interface that connects PE1 and CE1 is an Ethernet interface and the encapsulated link protocol is EthernetII. PE2 and CE2 are connected by the POS interface and the encapsulated link protocol is PPP, through which the L2VPN service is established between CE1 and CE2 and VPWS provides the heterogeneous medium communication L2VPN service.

Figure 1-20

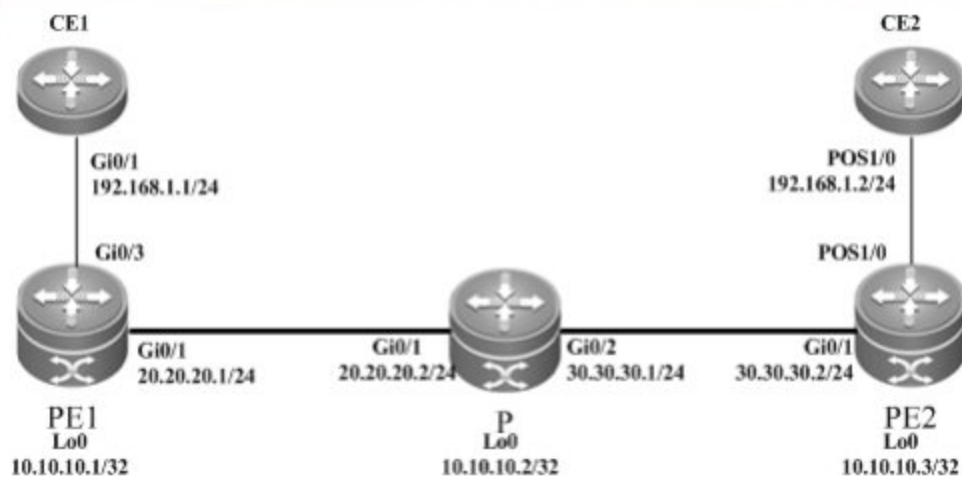

The configuration is general same as that for VLAN and PPP heterogeneous medium communication, except the access mode of PE1 and CE1.

2.2.1.26 Ethernet and MultiPPP Heterogeneous Medium Communication

As shown in the following network topology, the interface that connects PE1 and CE1 is an Ethernet interface and the encapsulated link protocol is EthernetII. PE2 and CE2 are connected by the Serial interface and the encapsulated link protocol is PPP, bound by two physical lines in the MultiPPP working mode, through which the L2VPN service is established between CE1 and CE2 and VPWS provides the heterogeneous medium communication L2VPN service.

Figure 1-21

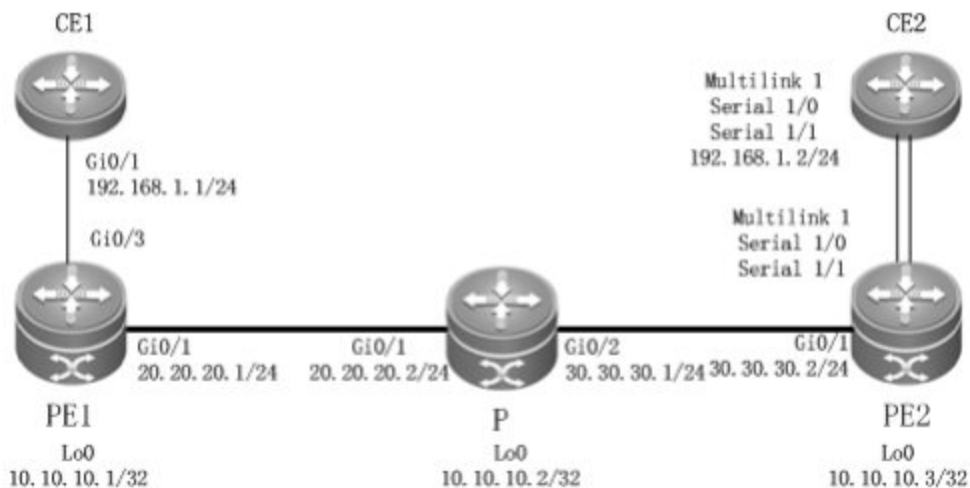

The configuration of CE1 and PE1 is general same as that for VLAN and PPP heterogeneous medium communication, except the access mode of PE1 and CE1.

The configuration of CE2 and PE2 is generally same as the configuration of CE when it is connected to PE through MutilPPP.

2.2.1.27 Ethernet and HDLC Heterogeneous Medium Communication

As shown in the following network topology, the interface that connects PE1 and CE1 is an Ethernet interface and the encapsulated link protocol is EthernetII. PE2 and CE2 are connected by the POS interface and the encapsulated link protocol is HDLC, through which the L2VPN service is established between CE1 and CE2 and VPWS provides the heterogeneous medium communication L2VPN service.

Figure 1-22

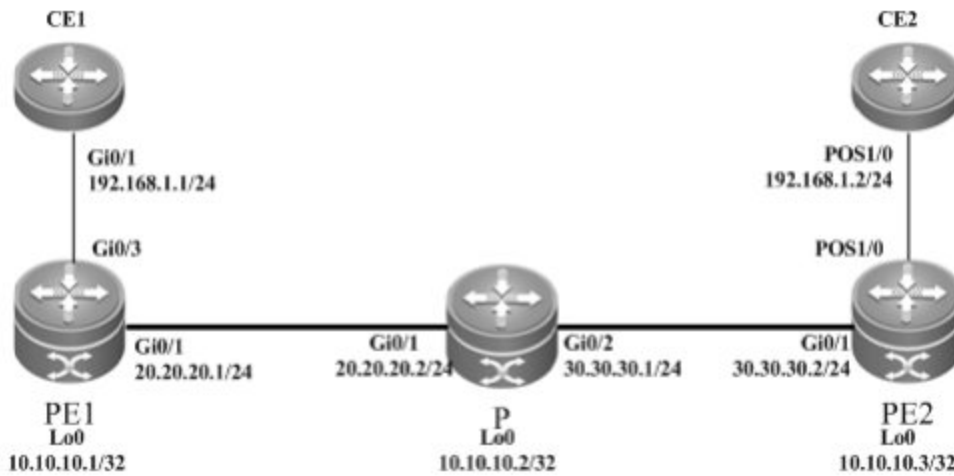

The configuration is general same as that for VLAN and HDLC heterogeneous medium communication, except the access mode of PE1 and CE1.

2.2.1.28 Option C Inter-AS VPWS

Figure 1-23 Option C: Inter-AS VPWS

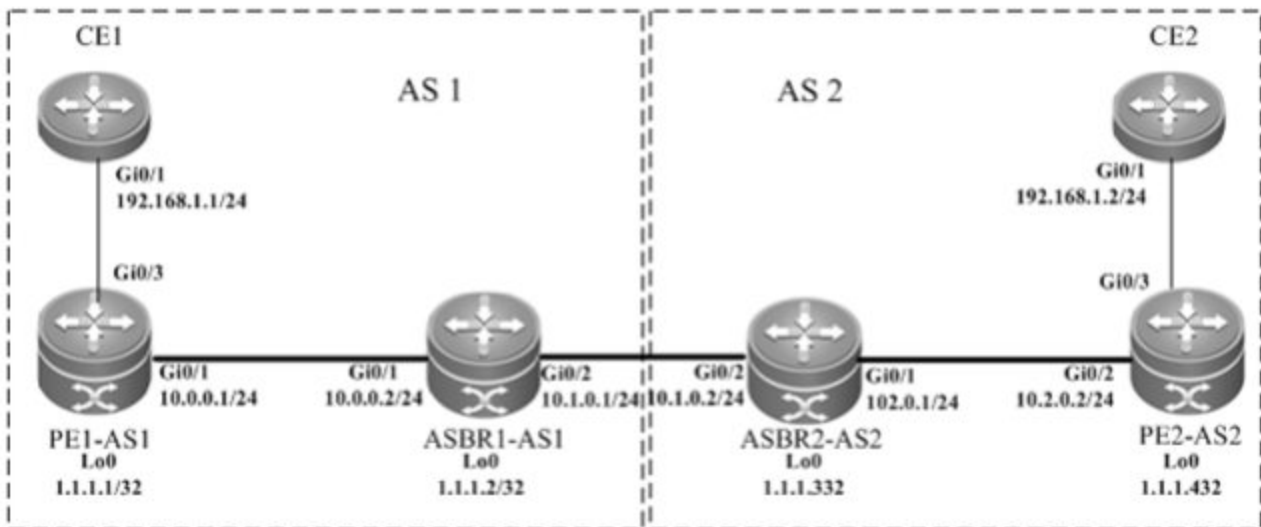

The above figure shows how to realize Inter-AS VPWS through the Option C solution. To set up a PW between PEs of different domains, PW information is not maintained on ASBR and OSPF is used in each AS as IGP to realize inter-AS communication. Assuming CE1 is connected to PE through the master port, it is required to establish L2VPN communication between CE1 and CE2. Configuration of devices is described as follows (only configuration related to the function is included):

Configuring CE1

```
Qttech# configure terminal
```

```
Qttech(config)# interface GigabitEthernet 0/1
```

The **no switchport** command is used to switch the port mode on switches to the Routed Port mode. It does not apply to routers and does not need to be used on routers.

```
Qttech(config if GigabitEthernet 0/1)# no switchport
```

```
Qttech(config if GigabitEthernet 0/1)# ip address 192.168.1.1 255.255.255.0
```

For routers, the fast-forwarding function of routers must be enabled on the interface. Switches do not need to use this command.

```
Qttech(config if gigabitethernet 0/1)# ip ref
```

```
Qttech(config if GigabitEthernet 0/1)# end
```

Similar with configuration of CE2

Configuring PE1-AS1

Configure the public network route protocol and MPLS signaling, and configure remote neighbors.

```
Qttech# configure terminal
```

```
Qttech(config)# interface loopback 0
```

```
Qttech(config if Loopback 0)# ip address 1.1.1.1 255.255.255.255
```

```
Qttech(config if Loopback 0)# exit
```

```
Qttech(config)# mpls ip
```

```
Qttech(config)# mpls router ldp
```

```
Qttech(config mpls router)# ldp router id interface loopback 0 force
```

```
Qttech(config mpls router)# neighbor 1.1.1.4
```

```
Qttech(config mpls router)# exit
```

```
Qttech(config)# router ospf 1
```

```
Qttech(config router)# network 10.0.0.0 0.0.0.255 area 0
```

```
Qttech(config router)# network 1.1.1.1 0.0.0.0 area 0
```

```
Qttech(config router)# exit
```

```
Qttech(config)# interface GigabitEthernet 0/1
```

The **no switchport** command is used to switch the port mode on switches to the Routed Port mode. It does not apply to routers and does not need to be used on routers.

```
Qttech(config if GigabitEthernet 0/1)# no switchport
```

For routers, the fast-forwarding function of routers must be enabled on the interface. Switches do not need to use this command.

```
Qttech(config if gigabitethernet 0/1)# ip ref
```

```
Qttech(config if GigabitEthernet 0/1)# ip address 10.0.0.1 255.255.255.0
```

```
Qttech(config if GigabitEthernet 0/1)# mpls ip
```

```
Qttech(config if GigabitEthernet 0/1)# label switching
```

```
Qttech(config if GigabitEthernet 0/1)# end
```

Configure BGP protocol.

```
Qtech# configure terminal
Qtech(config)# router bgp 1
Qtech(config router)# neighbor 1.1.1.2 remote as 1
Qtech(config router)# neighbor 1.1.1.2 update source loopback 0
Qtech(config router)# address family ipv4
Qtech(config router af)# neighbor 1.1.1.2 activate
Qtech(config router af)# neighbor 1.1.1.2 send label
Qtech(config router af)# end
```

Configure the user access VPWS.

```
Qtech# configure terminal
Qtech(config)# interface GigabitEthernet 0/3
```

For routers, the fast-forwarding function of routers must be enabled on the interface. Switches do not need to use this command.

```
Qtech(config if gigabitethernet 0/3)# ip ref
Qtech(config if GigabitEthernet 0/3)# xconnect 1.1.1.1 1 encapsulation mpls ethernet
Qtech(config if GigabitEthernet 0/3)# end
```

Similar with configuration of PE2-AS2

Configuring ASBR1-AS1

Configure Loopback interface.

```
Qtech(config)# interface loopback 0
Qtech(config if Loopback 0)# ip address 1.1.1.2 255.255.255.255
Qtech(config if Loopback 0)# exit
```

Configure the public network route protocol and MPLS signaling.

```
Qtech# configure terminal
Qtech(config)# mpls ip
Qtech(config)# mpls router ldp
Qtech(config mpls router)# ldp router id interface loopback 0 force
Qtech(config mpls router)# exit
Qtech(config)# interface GigabitEthernet 0/1
```

The **no switchport** command is used to switch the port mode on switches to the Routed Port mode. It does not apply to routers and does not need to be used on routers.

```
Qtech(config if GigabitEthernet 0/1)# no switchport
```

For routers, the fast-forwarding function of routers must be enabled on the interface. Switches do not need to use this command.

```
Qtech(config if gigabitethernet 0/3)# ip ref
Qtech(config if GigabitEthernet 0/1)# ip address 10.0.0.2 255.255.255.0
Qtech(config if GigabitEthernet 0/1)# mpls ip
Qtech(config if GigabitEthernet 0/1)# label switching
```

```
Qtech(config if GigabitEthernet 0/1)# exit
Qtech(config)# router ospf 1
Qtech(config router)# network 10.0.0.0 0.0.0.255 area 0
Qtech(config router)# network 1.1.1.2 0.0.0.0 area 0
Qtech(config router)# exit
```

Configure the IP address of the interface connected with ASBR2.

```
Qtech(config)# interface GigabitEthernet 0/2
```

The **no switchport** command is used to switch the port mode on switches to the Routed Port mode. It does not apply to routers and does not need to be used on routers.

```
Qtech(config if GigabitEthernet 0/2)# no switchport
```

For routers, the fast-forwarding function of routers must be enabled on the interface. Switches do not need to use this command.

```
Qtech(config if gigabitEthernet 0/2)# ip ref
Qtech(config if GigabitEthernet 0/2)# ip address 10.1.0.1 255.255.255.0
```

Enable the interface's label packet forwarding capability.

```
Qtech(config if GigabitEthernet 0/2)# label switching
Qtech(config if GigabitEthernet 0/2)# exit
```

Configure BGP protocol.

```
Qtech# configure terminal
Qtech(config)# router bgp 1
Qtech(config router)# neighbor 1.1.1.1 remote as 1
Qtech(config router)# neighbor 1.1.1.1 update source loopback 0
Qtech(config router)# neighbor 10.1.0.2 remote as 2
Qtech(config router)# address family ipv4
Qtech(config router af)# neighbor 1.1.1.1 activate
Qtech(config router af)# neighbor 1.1.1.1 send label
Qtech(config router af)# neighbor 10.1.0.2 activate
Qtech(config router af)# neighbor 10.1.0.2 send label
Qtech(config router af)# network 1.1.1.1 mask 255.255.255.255
Qtech(config router af)# end
```

The configuration of ASBR2-AS2 is similar with that of ASBR1-AS1.

The configuration of PE2-AS2 is similar with that of PE1-AS1.

The configuration of CE2 is similar with that of CE1.

Kompella VPWS Switch Configuration Instance

2.2.1.29 Applying access access mode between CEs and PEs, configuring PW to work in the Ethernet mode

Networking Requirements

- ❖ The interface that connects PEs and CEs works in the access mode, which means CEs are connected to PEs through the access link.
- ❖ PEs set up the PW service for the VLAN where the access port is located. PEs works in the Raw mode, frames transmitted by the PW set up between PE1 and PE2 do not carry vlan tag 10;

Topology

Figure 1-24

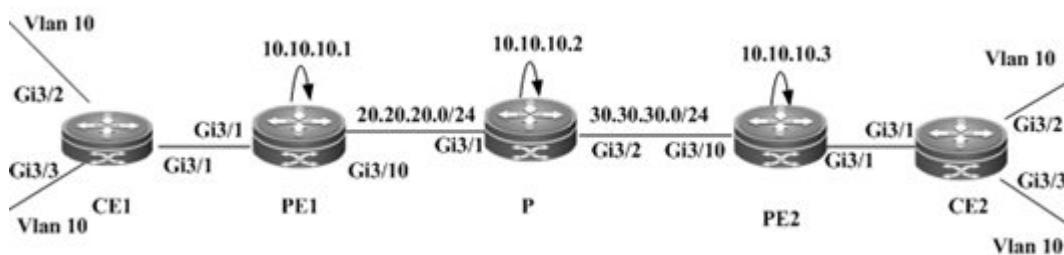

Notes

Before configuring Kompella VPWS, complete the following tasks:

- ❖ Run IGP in the carrier's network to realize connection between PE1 and PE2 devices;
- ❖ Connect CEs to PE devices through the access mode; and
- ❖ Obtain Kompella VPWS configuration information including VPWS instance descriptive information, RT value, CE ID, maximum planned site number, CE ID deviation and interface from the network administrator.

Configuration Steps

Configuring CE1:

Configure access port.

```
Qtech# configure terminal
Qtech(config)# interface gigabitethernet 3/2
Qtech(config-if Gigabitethernet 3/2)# switchport mode access
Qtech(config-if Gigabitethernet 3/2)# switchport access vlan 10
Qtech(config-if Gigabitethernet 3/2)# exit
```

```
Qtech(config)# interface gigabitethernet 3/3
Qtech(config if Gigabitethernet 3/3)# switchport mode access
Qtech(config if Gigabitethernet 3/3)# switchport access vlan 10
Qtech(config if Gigabitethernet 3/3)# end
```

Configure the access access mode on CEs and between PEs.

```
Qtech(config)# interface gigabitethernet 3/1
Qtech(config if Gigabitethernet 3/1)# switchport mode access
Qtech(config if Gigabitethernet 3/1)# switchport access vlan 10
Qtech(config if Gigabitethernet 3/1)# end
```

Configuring PE1:

Configure Loopback interface.

```
Qtech# configure terminal
Qtech(config)# interface loopback 0
Qtech(config if Loopback 0)# ip address 10.10.10.1 255.255.255.255
```

Configure the public network LSP tunnel and remote LDP neighbor.

```
Qtech(config)# mpls ip
Qtech(config)# mpls router ldp
Qtech(config mpls router)# ldp router id interface loopback 0 force
Qtech(config mpls router)# neighbor 10.10.10.3
Qtech(config mpls router)# exit
Qtech(config)# interface gigabitethernet 3/10
```

The `no switchport` command is used to switch the port mode on switches to the Routed Port mode. It does not apply to routers and does not need to be used on routers.

```
Qtech(config if Gigabitethernet 3/10)# no switchport
Qtech(config if Gigabitethernet 3/10)# ip address 20.20.20.1 255.255.255.0
Qtech(config if Gigabitethernet 3/10)# mpls ip
Qtech(config if Gigabitethernet 3/10)# label switching
Qtech(config if Gigabitethernet 3/10)# exit
Qtech(config)# router ospf 10
Qtech(config router)# network 20.20.20.0 0.0.0.255 area 0
Qtech(config router)# network 10.10.10.1 0.0.0.0 area 0
Qtech(config router)# end
```

Configure the access mode on PEs and between CEs.

```
Qtech# configure terminal
Qtech(config)# interface gigabitethernet 3/1
Qtech(config if Gigabitethernet 3/1)# switchport mode access
Qtech(config if Gigabitethernet 3/1)# switchport access vlan 10
Qtech(config if Gigabitethernet 3/1)# exit
```

Configure the L2VPN address family.

```

Qttech(config)# router bgp 100
Qttech(config router)# neighbor 10.10.10.3 remote as 100
Qttech(config router)# neighbor 10.10.10.3 update source loopback 0
Ruiije(config router)# address family l2vpn vpws
Qttech(config router af)# neighbor 10.10.10.3 activate
Qttech(config router af)# neighbor 10.10.10.3 send community extended
Qttech(config router af)# exit

```

Configure VFI instance.

```

Qttech# configure terminal
Qttech(config)# l2 vfi vpws 1 vpnid 1 point to point
Qttech(config vfi)# rd 1:1
Qttech(config vfi)# encapsulation mpls ethernet
Qttech(config vfi)# route target both 10000:1
Qttech(config vfi)# site id 1
Qttech(config vfi site)# xconnect interface vlan 10 remote ce id 2
Qttech(config vfi site)#exit site mode
Qttech(config vfi)#exit

```

Configuring P:

Configure the public network route protocol and LSP tunnel.

The configuration process is similar with the fore-mentioned MPLS basic function configuration instance.

Configuring PE2:

It is similar with PE1. See the configuration of PE1.

Configuring CE2:

It is similar with CE1. See the configuration of CE1.

Showing verification

After the configuration, CE1 can ping with CE 2.

After completing the configuration of Kompella VPWS, use the following commands to check the operation of VPWS.

Command	Function
Qttech# show bgp l2vpn vpws all	Display all the VPWS information.
Qttech# show mpls l2transport vc [vc_id [ip-address]] [interface interface_name] [detail]	Display information about PW (including VPWS PW and VPLS PW)
Qttech# show bgp l2vpn { vpls vpws } all connections [neighbor address] [interface interface_name] [site-id id] [detail]	Display PW's information.

Qtech# show mpls vfi [name]	Display all the configured or specified VFI information.
-------------------------------	--

2.2.1.30 Applying trunk access mode between CEs and PEs, configuring PW to work in the ethernetvlan mode

Networking Requirements

- ❖ CE1 and CE2 have two VLANs respectively. CEs are connected to PEs through Trunk.
- ❖ PEs have to establish a PW for each user's VLAN; multiple VLAN interfaces share one physical port. PE1 and PE2 established two PWs for VLAN10 and VLAN20 respectively to transmit frames carrying VLAN Tag 10 and Vlan tag 20;

Topology

Figure 1-25

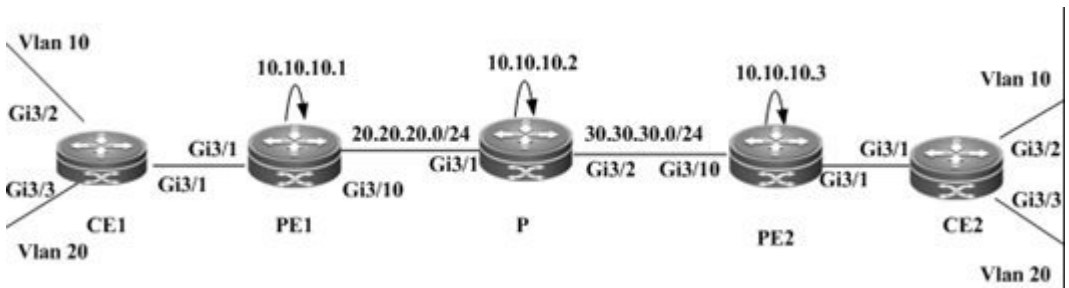

Notes

Before configuring Kompella VPWS, complete the following tasks:

- ❖ Run IGP in the carrier's network to realize connection between PE1 and PE2 devices;
- ❖ Connect CEs to PE devices through the trunk mode; and
- ❖ Obtain Kompella VPWS configuration information including VPWS instance descriptive information, RT value, CE ID, maximum planned site number, CE ID deviation and interface from the network administrator.

Configuration Steps

Configuring CE1:

Configure access port.

```
Qtech# configure terminal
Qtech(config)# interface gigabitethernet 3/2
Qtech(config if Gigabitethernet 3/2)# switchport mode access
Qtech(config if Gigabitethernet 3/2)# switchport access vlan 10
Qtech(config if Gigabitethernet 3/2)# exit
Qtech(config)# interface gigabitethernet 3/3
Qtech(config if Gigabitethernet 3/3)# switchport mode access
```

```
Qtech(config if Gigabitethernet 3/3)# switchport access vlan 20
Qtech(config if Gigabitethernet 3/3)# end
```

Configure the trunk interface on CEs for connection with PEs.

```
Qtech(config)# interface gigabitethernet 3/1
Qtech(config if Gigabitethernet 3/1)# switchport mode trunk
Qtech(config if Gigabitethernet 3/1)# switchport trunk allow vlan add 10, 20
Qtech(config if Gigabitethernet 3/1)# end
```

Configuring PE1:

Configure Loopback interface.

```
Qtech# configure terminal
Qtech(config)# interface loopback 0
Qtech(config if Loopback 0)# ip address 10.10.10.1 255.255.255.255
```

Configure the public network LSP tunnel and remote LDP neighbor.

The configuration is similar with that for applying the access access mode between CEs and PEs.

Configure the trunk interface on PEs for connection with CEs.

```
Qtech(config)# vlan 10
Qtech(config vlan)# exit
Qtech(config)# interface vlan 10
Qtech (config VLAN 10) # exit
Qtech(config)# vlan 20
Qtech(config vlan)# exit
Qtech(config)# interface vlan 20
Qtech (config VLAN 20) # exit
Qtech(config)# interface gigabitethernet 3/1
Qtech(config if Gigabitethernet 3/1)# switchport mode trunk
Qtech(config if Gigabitethernet 3/1)# end
```

Configure the L2VPN address family.

```
Qtech(config)# router bgp 100
Qtech(config router)# neighbor 10.10.10.3 remote as 100
Qtech(config router)# neighbor 10.10.10.3 update source loopback 0
Ruiije(config router)# address family l2vpn vpws
Qtech(config router af)# neighbor 10.10.10.3 activate
Qtech(config router af)# neighbor 10.10.10.3 send community extended
Qtech(config router af)# exit
```

Configure VFI instance.

```
Qtech# configure terminal
Qtech(config)# 12 vfi vpws 1 vpnid 1 point to point
Qtech(config vfi)# rd 1:1
```

```

Qttech(config vfi)# encapsulation mpls ethernetvlan
Qttech(config vfi)# route target both 10000:1
Qttech(config vfi)# site id 1
Qttech(config vfi site)# xconnect interface vlan 10 remote ce id 2
Qttech(config vfi site)#exit site mode
Qttech(config vfi)# site id 3
Qttech(config vfi site)# xconnect interface vlan 20 remote ce id 4
Qttech(config vfi site)#exit site mode

```

Configuring P:

Configure the public network's LSP tunnel.

The configuration is similar with that for applying the access access mode between CEs and PEs.

Configuring PE2:

The configuration is similar with that of PE1. See the configuration of PE1.

CE2

The configuration is similar with that of CE1. See the configuration of CE1.

Showing verification

After the configuration, CE1 can ping with CE 2.

After completing the configuration of Kompella VPWS, use the following commands to check the operation of VPWS.

Command	Function
Qttech# show bgp l2vpn vpws all	Display all the VPWS information.
Qttech# show mpls l2transport vc [vc_id [ip-address]] [interface interface_name] [detail]	Display information about PW (including VPWS PW and VPLS PW)
Qttech# show bgp l2vpn { vpls vpws } all connections [neighbor address] [interface interface_name] [site-id id] [detail]	Display PW's information.
Qttech# show mpls vfi [name]	Display all the configured or specified VFI information.

2.2.1.31 Applying dot1q tunnel access mode between CEs and PEs, configuring PW to work in the Ethernet mode

Networking Requirements

- ❖ The PW service is provided for a physical interface on PEs so that CEs can connect to PEs through the dot1q tunnel and the PW service can be enabled on the VLAN interface where the tunnel is located. Therefore, the VLAN Tag carried by user's frames will be transmitted transparently;

- ❖ Working in the Raw mode, the PW set up between PE1 and PE2 transmits frames with layer-1 VLAN tags, which are VLAN tags carried by frames received on CEs;

Topology

Figure 1-26 Kompella VPWS's dot1q tunnel access mode

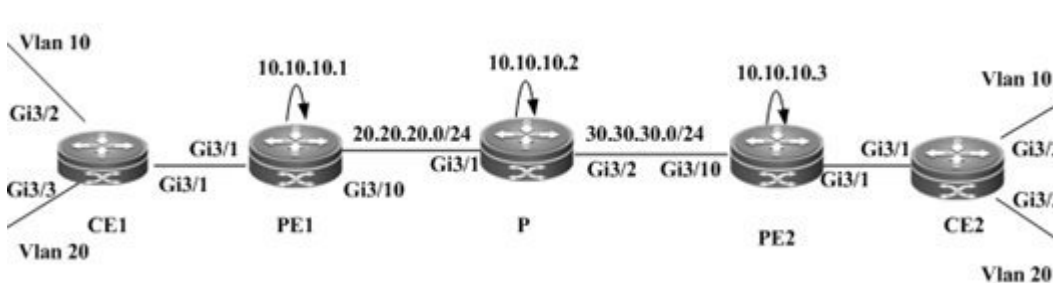

Notes

Before configuring Kompella VPWS, complete the following tasks:

- ❖ Run IGP in the carrier's network to realize connection between PE1 and PE2 devices;
- ❖ Connect CEs to PE devices through the dot1q tunnel mode; and
- ❖ Obtain Kompella VPWS configuration information including VPWS instance descriptive information, RT value, CE ID, maximum planned site number, CE ID deviation and interface from the network administrator.

Configuration Steps

Configuring CE1:

Configure access port.

```
Qtech# configure terminal
Qtech(config)# interface gigabitethernet 3/2
Qtech(config-if GigabitEthernet 3/2)# switchport mode access
Qtech(config-if GigabitEthernet 3/2)# switchport access vlan 10
Qtech(config-if GigabitEthernet 3/2)# exit
Qtech(config)# interface gigabitethernet 3/3
Qtech(config-if GigabitEthernet 3/3)# switchport mode access
Qtech(config-if GigabitEthernet 3/3)# switchport access vlan 20
Qtech(config-if GigabitEthernet 3/3)# end
```

Configure the trunk interface on CEs for connection with PEs.

```
Qtech(config)# interface gigabitethernet 3/1
Qtech(config-if GigabitEthernet 3/1)# switchport mode trunk
Qtech(config-if GigabitEthernet 3/1)# switchport trunk allow vlan add 10, 20
Qtech(config-if GigabitEthernet 3/1)# end
```

Configuring PE1:

Configure Loopback interface.

```
Qtech# configure terminal
Qtech(config)# interface loopback 0
Qtech(config if Loopback 0)# ip address 10.10.10.1 255.255.255.255
```

Configure the public network LSP tunnel and remote LDP neighbor.

The configuration is similar with that for applying the access access mode between CEs and PEs.

#Configure PEs to connect with CEs through dot1q.

```
Qtech(config)# vlan 2
Qtech(config vlan)# exit
Qtech(config)# interface vlan 2
Qtech (config VLAN 2) # exit
Qtech(config)# interface gigabitethernet 3/1
Qtech(config if Gigabitethernet 3/1)# switchport access vlan 2
Qtech(config if Gigabitethernet 3/1)# switchport mode dot1q tunnel
Qtech(config if Gigabitethernet 3/1)# exit
Qtech(config)# interface vlan 2
Qtech(config if Vlan 2)# exit
```

Configure the L2VPN address family.

```
Qtech(config)# router bgp 100
Qtech(config router)# neighbor 10.10.10.3 remote as 100
Qtech(config router)# neighbor 10.10.10.3 update source loopback 0
Ruiije(config router)# address family l2vpn vpws
Qtech(config router af)# neighbor 10.10.10.3 activate
Qtech(config router af)# neighbor 10.10.10.3 send community extended
Qtech(config router af)# exit
```

Configure VFI instance.

```
Qtech# configure terminal
Qtech(config)# l2 vfi vpws 1 vpnid 1 point to point
Qtech(config vfi)# rd 1:1
Qtech(config vfi)# encapsulation mpls ethernet
Qtech(config vfi)# route target both 10000:1
Qtech(config vfi)# site id 1
Qtech(config vfi site)# xconnect interface vlan 10 remote ce id 2
Qtech(config vfi site)#exit site mode
Qtech(config vfi)#exit
```

Configuring P:

The configuration is similar with that for applying the access access mode between CEs and PEs.

Configuring PE2:

The configuration is similar with PE1.

CE2

The configuration is similar with CE1.

Showing verification

After the configuration, CE1 can ping with CE 2.

After completing the configuration of Kompella VPWS, use the following commands to check the operation of VPWS.

Command	Function
Qtech# show bgp l2vpn vpws all	Display all the VPWS information.
Qtech# show mpls l2transport vc [<i>vc_id</i> [<i>ip-address</i>]] [interface <i>interface_name</i>] [detail]	Display information about PW (including VPWS PW and VPLS PW)
Qtech# show bgp l2vpn { vpls vpws } all connections [neighbor <i>address</i>] [interface <i>interface_name</i>] [site-id <i>id</i>] [detail]	Display PW's information.
Qtech# show mpls vfi [<i>name</i>]	Display all the configured or specified VFI information.

2.2.1.32 Option A Inter-AS VPWS

Networking Requirements

- ❖ CE devices of customer S in Site A and Site B are connected with each other through the carrier's PE1 in AS100 and PE2 in AS 200, realizing layer-2 point-to-point connection;
- ❖ PE1 and PE2 are in different autonomous domains. ASBR 1 and ASBR 2 are considered CE devices by each other, which means the interface between ASBRs connects AC to VFI instance;

Topology

Figure 1-27 Kompella VPWS Inter-AS networking topology

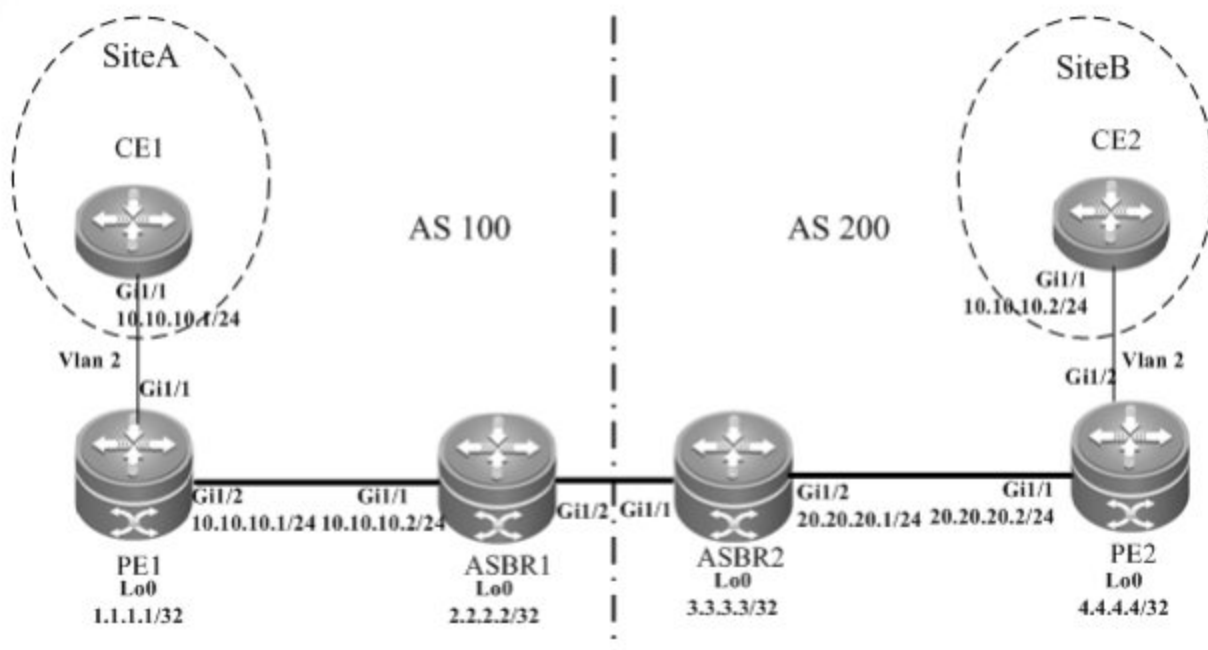

The above figure shows the structure of the Kompella VPWS Inter-AS networking topology in Option A. The intermediate interface is considered by ASBRs as AC access.

Notes

Before configuring Kompella VPWS, complete the following tasks:

- ❖ Run IGP in the carrier's network to realize connection between PE and ASBR devices;
- ❖ Establish MP-IBGP peer relationship between PEs and ASBRs in the domain;
- ❖ Obtain Kompella VPWS configuration information including VPWS instance descriptive information, RT value, CE ID, maximum planned site number, CE ID deviation and interface from the network administrator.

Configuration Steps

- ❖ Configuring CE1

See "Configuring CE1" in basic configuration examples.

- ❖ Configuring PE1

Configure Loopback interface address.

```
Qtech(config)# interface loopback 0
Qtech(config-if-Loopback 0)# ip address 1.1.1.1 255.255.255.255
Qtech(config-if-Loopback 0)# exit
```

Configure OSPF protocol, establish the public network route so that PEs can ping with ASBRs in the same domain.

```
Qttech(config)# router ospf 10
Qttech(config router)# network 1.1.1.1 0.0.0.0 area 0
Qttech(config router)# network 10.10.10.0 0.0.0.255 area 0
Qttech(config router)# exit
```

Configure LDP protocol and enable MPLS globally.

```
Qttech(config)# mpls ip
Qttech(config)# mpls router ldp
Qttech(config mpls router)# ldp router id interface loopback 0 force
Qttech(config mpls router)# exit
```

#Configure the public network tunnel between PEs.

```
Qttech(config)# interface gigabitEthernet 1/2
Qttech(config if GigabitEthernet 1/2)# no switchport
Qttech(config if GigabitEthernet 1/2)# ip address 10.10.10.1 255.255.255.0
Qttech(config if GigabitEthernet 1/2)# mpls ip
Qttech(config if GigabitEthernet 1/2)# label switching
Qttech(config if GigabitEthernet 1/2)# exit
```

Configure the user access VPWS.

```
Qttech# configure terminal
Qttech(config)# vlan 2
Qttech(config vlan)# exit
Qttech(config)# interface vlan 2
Qttech (config VLAN 2) # exit
Qttech(config)# interface GigabitEthernet 1/1
Qttech(config if GigabitEthernet 1/1)# switchport access vlan 2
Qttech(config if GigabitEthernet 1/1)# exit
Qttech(config)# interface vlan 2
Qttech(config if vlan 2)# end
```

Configure the L2VPN address family.

```
Qttech(config)# router bgp 100
Qttech(config router)# neighbor 2.2.2.2 remote as 100
Qttech(config router)# neighbor 2.2.2.2 update source loopback 0
Ruiije(config router)# address family l2vpn vpws
Qttech(config router af)# neighbor 2.2.2.2 activate
Qttech(config router af)# neighbor 2.2.2.2 send community extended
Qttech(config router af)# exit
```

Configure VFI instance.

```
Qttech# configure terminal
Qttech(config)# l2 vfi vpws 1 vpnid 1 point to point
Qttech(config vfi)# rd 100:1
```

```
Qtech(config vfi)# encapsulation mpls ethernet
Qtech(config vfi)# route target both 10000:1
Qtech(config vfi)# site id 1
Qtech(config vfi site)# xconnect interface vlan 2 remote ce id 2
Qtech(config vfi site)#exit site mode
Qtech(config vfi)#exit
```

❖ Configure ASBR 1

Configure Loopback interface address.

```
Qtech(config)# interface loopback 0
Qtech(config if Loopback 0)# ip address 2.2.2.2 255.255.255.255
Qtech(config if Loopback 0)# exit
```

Configure OSPF protocol, establish the public network route so that PEs can ping with ASBRs in the same domain.

```
Qtech(config)# router ospf 10
Qtech(config router)# network 2.2.2.2 0.0.0.0 area 0
Qtech(config router)# network 10.10.10.0 0.0.0.255 area 0
Qtech(config router)# exit
```

Configure LDP protocol and enable MPLS globally.

```
Qtech(config)# mpls ip
Qtech(config)# mpls router ldp
Qtech(config mpls router)# ldp router id interface loopback 0 force
Qtech(config mpls router)# exit
```

#Configure the public network tunnel between PEs.

```
Qtech(config)# interface gigabitEthernet 1/1
Qtech(config if GigabitEthernet 1/1)# no switchport
Qtech(config if GigabitEthernet 1/1)# ip address 10.10.10.2 255.255.255.0
Qtech(config if GigabitEthernet 1/1)# mpls ip
Qtech(config if GigabitEthernet 1/1)# label switching
Qtech(config if GigabitEthernet 1/1)# exit
```

Configure the L2VPN address family.

```
Qtech(config)# router bgp 100
Qtech(config router)# neighbor 1.1.1.1 remote as 100
Qtech(config router)# neighbor 1.1.1.1 update source loopback 0
Ruiije(config router)# address family l2vpn vpws
Qtech(config router af)# neighbor 1.1.1.1 activate
Qtech(config router af)# exit
```

Configure the interface that connects ASBR 1 and ASBR 2.

```
Qtech# configure terminal
```

```
Qtech(config)# vlan 2
Qtech(config vlan)# exit
Qtech(config)# interface vlan 2
Qtech (config VLAN 2) # exit
Qtech(config)# interface GigabitEthernet 1/2
Qtech(config if GigabitEthernet 1/2)# switchport access vlan 2
Qtech(config if GigabitEthernet 1/2)# exit
Qtech(config)# interface vlan 2
Qtech(config if vlan 2)# end
```

Configure a VPWS instance.

```
Qtech# configure terminal
Qtech(config)# 12 vfi vpws 1 vpnid 2 point to point
Qtech(config vfi)# rd 100:1
Qtech(config vfi)# encapsulation mpls ethernet
Qtech(config vfi)# route target both 10000:1
Qtech(config vfi)# site id 2
Qtech(config vfi site)# xconnect interface vlan 2 remote ce id 1
Qtech(config vfi site)#exit site mode
Qtech(config vfi)#exit
```

❖ Configure ASBR 2

Configure Loopback interface address.

```
Qtech(config)# interface loopback 0
Qtech(config if Loopback 0)# ip address 3.3.3.3 255.255.255.255
Qtech(config if Loopback 0)# exit
```

Configure OSPF protocol, establish the public network route so that PEs can ping with ASBRs in the same domain.

```
Qtech(config)# router ospf 10
Qtech(config router)# network 3.3.3.3 0.0.0.0 area 0
Qtech(config router)# network 20.20.20.0 0.0.0.255 area 0
Qtech(config router)# exit
```

Configure LDP protocol and enable MPLS globally.

```
Qtech(config)# mpls ip
Qtech(config)# mpls router ldp
Qtech(config mpls router)# ldp router id interface loopback 0 force
Qtech(config mpls router)# exit
```

#Configure the public network tunnel between PEs.

```
Qtech(config)# interface gigabitEthernet 1/2
Qtech(config if GigabitEthernet 1/2)# ip address 20.20.20.2 255.255.255.0
Qtech(config if GigabitEthernet 1/2)# mpls ip
```

```
Qtech(config if GigabitEthernet 1/2)# label switching
Qtech(config if GigabitEthernet 1/2)# exit
```

Configure the L2VPN address family.

```
Qtech(config)# router bgp 200
Qtech(config router)# neighbor 4.4.4.4 remote as 200
Qtech(config router)# neighbor 4.4.4.4 update source loopback 0
Ruiije(config router)# address family l2vpn vpws
Qtech(config router af)# neighbor 4.4.4.4 activate
Qtech(config router af)# neighbor 4.4.4.4 send community extended
Qtech(config router af)# exit
```

Configure the interface that connects ASBR 2 and ASBR.

```
Qtech# configure terminal
Qtech(config)# vlan 2
Qtech(config vlan)# exit
Qtech(config)# interface vlan 2
Qtech (config VLAN 2) # exit
Qtech(config)# interface GigabitEthernet 1/1
Qtech(config if GigabitEthernet 1/1)# switchport access vlan 2
Qtech(config if GigabitEthernet 1/1)# exit
Qtech(config)# interface vlan 2
Qtech(config if vlan 2)# end
```

Configure a VPWS instance.

```
Qtech# configure terminal
Qtech(config)# l2 vfi vpws 1 vpnid 1 point to point
Qtech(config vfi)# rd 200:1
Qtech(config vfi)# encapsulation mpls ethernet
Qtech(config vfi)# route target both 10000:1
Qtech(config vfi)# site id 3
Qtech(config vfi site)# xconnect interface vlan 2 remote ce id 4
Qtech(config vfi site)#exit site mode
Qtech Networks(config vfi)#exit
```

❖ Configuring PE2

Configure Loopback interface address.

```
Qtech(config)# interface loopback 0
Qtech(config if Loopback 0)# ip address 4.4.4.4 255.255.255.255
Qtech(config if Loopback 0)# exit
```

Configure OSPF protocol, establish the public network route so that PEs can ping with ASBRs in the same domain.

```
Qtech(config)# router ospf 10
```

```
Qttech(config router)# network 4.4.4.4 0.0.0.0 area 0
Qttech(config router)# network 20.20.20.0 0.0.0.255 area 0
Qttech(config router)# exit
```

Configure LDP protocol and enable MPLS globally.

```
Qttech(config)# mpls ip
Qttech(config)# mpls router ldp
Qttech(config mpls router)# ldp router id interface loopback 0 force
Qttech(config mpls router)# exit
```

#Configure the public network tunnel between PEs.

```
Qttech(config)# interface gigabitEthernet 1/1
Qttech(config if GigabitEthernet 1/1)# ip address 20.20.20.1 255.255.255.0
Qttech(config if GigabitEthernet 1/1)# mpls ip
Qttech(config if GigabitEthernet 1/1)# label switching
Qttech(config if GigabitEthernet 1/1)# exit
```

Configure the L2VPN address family.

```
Qttech(config)# router bgp 200
Qttech(config router)# neighbor 3.3.3.3 remote as 200
Qttech(config router)# neighbor 3.3.3.3 update source loopback 0
Qttech(config router)# address family l2vpn vpws
Qttech(config router af)# neighbor 3.3.3.3 activate
Qttech(config router af)# neighbor 3.3.3.3 send community extended
Qttech(config router af)# exit
```

Configure the interface that connects PE 2 and CE.

```
Qttech# configure terminal
Qttech(config)# vlan 2
Qttech(config vlan)# exit
Qttech(config)# interface vlan 2
Qttech (config VLAN 2) # exit
Qttech(config)# interface GigabitEthernet 1/2
Qttech(config if GigabitEthernet 1/2)# switchport access vlan 2
Qttech(config if GigabitEthernet 1/2)# exit
Qttech(config)# interface vlan 2
Qttech(config if vlan 2)# end
```

Configure a VPWS instance.

```
Qttech# configure terminal
Qttech(config)# l2 vfi vpws 1 vpnid 1 autodiscovery
Qttech(config vfi)# rd 200:1
Qttech(config vfi)# signal bgp
Qttech(config vfi)# encapsulation mpls ethernet
Qttech(config vfi)# route target both 10000:1
```

```

Qttech(config vfi)# site id 4
Qttech(config vfi site)# xconnect interface vlan 2 remote ce id 3
Qttech(config vfi site)#exit site mode
Qttech(config vfi)#exit

```

❖ Configuring CE2

See "Configuring CE2" in basic configuration examples.

Displaying verification

After the configuration, CE1 can ping with CE 2.

After completing the configuration of Kompella VPWS, use the following commands to check the operation of VPWS.

Command	Function
Qttech# show bgp l2vpn vpws all	Display all the VPWS information.
Qttech# show mpls l2transport vc [<i>vc_id</i> [<i>ip-address</i>]] [interface <i>interface_name</i>] [detail]	Display information about PW (including VPWS PW and VPLS PW)
Qttech# show bgp l2vpn { vpls vpws } all connections [neighbor <i>address</i>] [interface <i>interface_name</i>] [site-id <i>id</i>] [detail]	Display PW's information.
Qttech# show mpls vfi [<i>name</i>]	Display all the configured or specified VFI information.

2.2.1.33 Option C Inter-AS VPWS

Networking Requirements

- ❖ Adopt Option C to realize Inter-AS VPWS;
- ❖ To set up a PW between PEs of different domains, PW information is not maintained on ASBR and OSPF is used in each AS as IGP to realize inter-AS communication;
- ❖ Assuming CE1 is connected to PE through the access port, it is required to establish L2VPN communication between CE1 and CE2.

Topology

Figure 1-28 Option C: Inter-AS VPWS

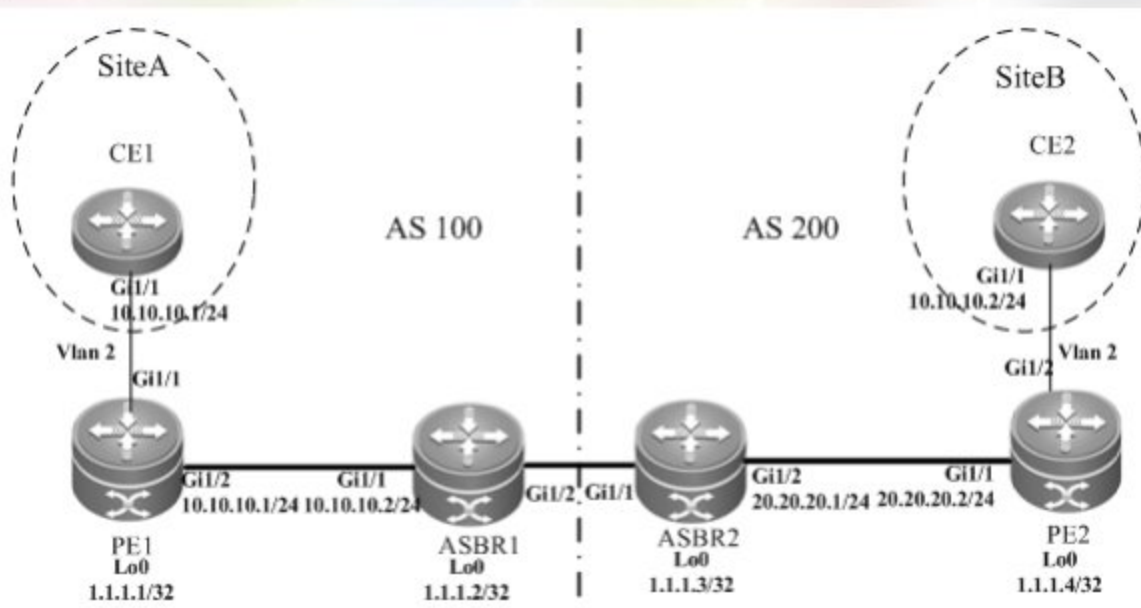

Note If CE1 and CE2 are connected to PEs through other modes such as Trunk mode, you only need to adjust the configuration of L2VPN in the VLAN interface mode (see configuration instances of various access modes for L2VPN). The configuration BGP and public network's IGP and MPLS does not need to be modified.

Notes

Before configuring Kompella VPWS, complete the following tasks:

- ❖ Run IGP in the carrier's network to realize connection between PE and ASBR devices;
- ❖ Establish MP-IBGP peer relationship between PEs and ASBRs in the domain;
- ❖ Obtain Kompella VPWS configuration information including VPWS instance descriptive information, RT value, CE ID, maximum planned site number, CE ID deviation and interface from the network administrator.

Configuration Steps

Configuring CE1

```
Qtech# configure terminal
Qtech(config)# interface GigabitEthernet 1/1
```

The **no switchport** command is used to switch the port mode on switches to the Routed Port mode. It does not apply to routers and does not need to be used on routers.

```
Qtech(config-if-GigabitEthernet 1/1)# no switchport
Qtech(config-if-GigabitEthernet 1/1)# ip address 192.168.1.1 255.255.255.0
Qtech(config-if-GigabitEthernet 1/1)# end
```

Similar with configuration of CE2

Configuring PE1-AS1

Configure the public network route protocol and MPLS signaling, and configure remote neighbors.

```
Qtech# configure terminal
Qtech(config)# interface loopback 0
Qtech(config if Loopback 0)# ip address 1.1.1.1 255.255.255.255
Qtech(config if Loopback 0)# exit
Qtech(config)# mpls ip
Qtech(config)# mpls router ldp
Qtech(config mpls router)# ldp router id interface loopback 0 force
Qtech(config mpls router)# neighbor 1.1.1.4
Qtech(config mpls router)# exit
Qtech(config)# router ospf 1
Qtech(config router)# network 10.0.0.0 0.0.0.255 area 0
Qtech(config router)# network 1.1.1.1 0.0.0.0 area 0
Qtech(config router)# exit
Qtech(config)# interface GigabitEthernet 0/1
```

The **no switchport** command is used to switch the port mode on switches to the Routed Port mode. It does not apply to routers and does not need to be used on routers.

```
Qtech(config if GigabitEthernet 1/2)# no switchport
Qtech(config if GigabitEthernet 1/2)# ip address 10.0.0.1 255.255.255.0
Qtech(config if GigabitEthernet 1/2)# mpls ip
Qtech(config if GigabitEthernet 1/2)# label switching
Qtech(config if GigabitEthernet 1/2)# end
```

Configure BGP protocol.

```
Qtech# configure terminal
Qtech(config)# router bgp 100
Qtech(config router)# neighbor 1.1.1.2 remote as 100
Qtech(config router)# neighbor 1.1.1.2 update source loopback 0
Qtech(config router)# address family ipv4
Qtech(config router af)# neighbor 1.1.1.2 activate
Qtech(config router af)# neighbor 1.1.1.2 send label
Qtech(config router af)# end
```

Configure the user access VPWS.

```
Qtech# configure terminal
Qtech(config)# vlan 2
Qtech(config vlan)# exit
Qtech(config)# interface vlan 2
Qtech (config VLAN 2) # exit
Qtech(config)# interface GigabitEthernet 1/1
```

```
Qtech(config if GigabitEthernet 1/1)# switchport access vlan 2
Qtech(config if GigabitEthernet 1/1)# exit
Qtech(config)# interface vlan 2
Qtech(config if vlan 2)# end
```

Configure the L2VPN address family.

```
Qtech(config)# router bgp 100
Qtech(config router)# neighbor 1.1.1.4 remote as 100
Qtech(config router)# neighbor 1.1.1.4 update source loopback 0
Qtech(config router)# neighbor 1.1.1.4 ebgp multihop
Ruiije(config router)# address family l2vpn vpws
Qtech(config router af)# neighbor 1.1.1.4 activate
Qtech(config router af)# neighbor 1.1.1.4 send community extended
Qtech(config router af)# exit
```

Configure VFI instance.

```
Qtech# configure terminal
Qtech(config)# l2 vfi vpws 1 vpnid 1 point to point
Qtech(config vfi)# rd 1:1
Qtech(config vfi)# encapsulation mpls ethernetvlan
Qtech(config vfi)# route target both 10000:1
Qtech(config vfi)# site id 1
Qtech(config vfi site)# xconnect interface vlan 2 remote ce id 2
Qtech(config vfi site)#exit site mode
```

Similar with configuration of PE2-AS2

Configuring ASBR1-AS1

Configure Loopback interface.

```
Qtech(config)# interface loopback 0
Qtech(config if Loopback 0)# ip address 1.1.1.2 255.255.255.255
Qtech(config if Loopback 0)# exit
```

Configure the public network route protocol and MPLS signaling.

```
Qtech# configure terminal
Qtech(config)# mpls ip
Qtech(config)# mpls router ldp
Qtech(config mpls router)# ldp router id interface loopback 0 force
Qtech(config mpls router)# exit
Qtech(config)# interface GigabitEthernet 1/1
```

The **no switchport** command is used to switch the port mode on switches to the Routed Port mode. It does not apply to routers and does not need to be used on routers.

```
Qtech(config if GigabitEthernet 1/1)# no switchport
Qtech(config if GigabitEthernet 1/1)# ip address 10.0.0.2 255.255.255.0
```

```
Qtech(config if GigabitEthernet 1/1)# mpls ip
Qtech(config if GigabitEthernet 1/1)# label switching
Qtech(config if GigabitEthernet 1/1)# exit
Qtech(config)# router ospf 1
Qtech(config router)# network 10.0.0.0 0.0.0.255 area 0
Qtech(config router)# network 1.1.1.2 0.0.0.0 area 0
Qtech(config router)# exit
```

Configure the IP address of the interface connected with ASBR2.

```
Qtech(config)# interface GigabitEthernet 1/2
```

The **no switchport** command is used to switch the port mode on switches to the Routed Port mode. It does not apply to routers and does not need to be used on routers.

```
Qtech(config if GigabitEthernet 1/2)# no switchport
Qtech(config if GigabitEthernet 1/2)# ip address 10.1.0.1 255.255.255.0
```

Enable the interface's label packet forwarding capability.

```
Qtech(config if GigabitEthernet 1/2)# label switching
Qtech(config if GigabitEthernet 1/2)# exit
```

Configure BGP protocol.

```
Qtech# configure terminal
Qtech(config)# router bgp 100
Qtech(config router)# neighbor 1.1.1.1 remote as 100
Qtech(config router)# neighbor 1.1.1.1 update source loopback 0
Qtech(config router)# neighbor 10.1.0.2 remote as 200
Qtech(config router)# address family ipv4
Qtech(config router af)# neighbor 1.1.1.1 activate
Qtech(config router af)# neighbor 1.1.1.1 send label
Qtech(config router af)# neighbor 10.1.0.2 activate
Qtech(config router af)# neighbor 10.1.0.2 send label
Qtech(config router af)# network 1.1.1.1 mask 255.255.255.255
Qtech(config router af)# end
```

The configuration of ASBR2-AS2 is similar with that of ASBR1-AS1.

The configuration of PE2-AS2 is similar with that of PE1-AS1.

The configuration of CE2 is similar with that of CE1.

Displaying verification

After the configuration, CE1 can ping with CE 2.

After completing the configuration of Kompella VPWS, use the following commands to check the operation of VPWS.

Command	Function
Qtech# show bgp l2vpn vpws all	Display all the VPWS information.
Qtech# show mpls l2transport vc [vc_id [ip-address]] [interface interface_name] [detail]	Display information about PW (including VPWS PW and VPLS PW)
Qtech# show bgp l2vpn { vpls vpws } all connections [neighbor address] [interface interface_name] [site-id id] [detail]	Display PW's information.
Qtech# show mpls vfi [name]	Display all the configured or specified VFI information.

Kompella VPWS Router Configuration Instance

2.2.1.34 Connecting CEs to PEs through Ethernet

As shown in the following network topology, the interface that connects PEs and CEs is an Ethernet interface, which means CEs are connected to PEs through the Ethernet interface, through which the L2VPN service is set up between CE1 and CE2.

Figure 1-29

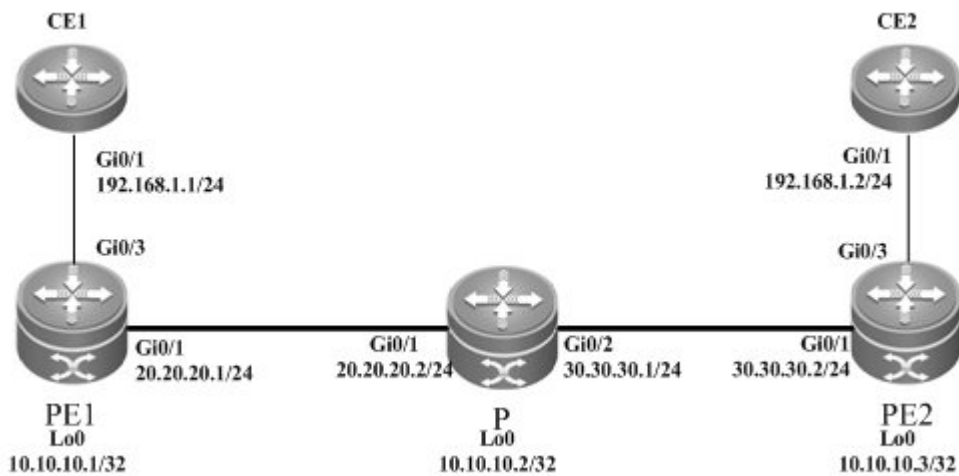

The configuration process is described as follows:

Configuring CE1:

Configure the interface that connects CE1 and PE2.

```
Qtech(config)# interface gigabitethernet 0/1
Qtech(config if Gigabitethernet 0/1)# ip address 192.168.1.1 255.255.255.0
```

For routers, the fast-forwarding function of routers must be enabled on the interface. Switches do not need to use this command.

```
Qtech(config if gigabitEthernet 0/1)# ip ref
Qtech(config if GigabitEthernet 0/1)# end
```

Configuring PE1:

Configure Loopback interface address.

```
Qtech(config)# interface loopback 0
Qtech(config if Loopback 0)# ip address 10.10.10.1 255.255.255.255
Qtech(config if Loopback 0)# exit
```

Configure OSPF protocol and establish the public network route.

```
Qtech(config)# router ospf 10
Qtech(config router)# network 10.10.10.1 0.0.0.0 area 0
Qtech(config router)# network 20.20.20.0 0.0.0.255 area 0
Qtech(config router)# exit
```

Configure LDP protocol and enable MPLS globally.

```
Qtech(config)# mpls ip
Qtech(config)# mpls router ldp
Qtech(config mpls router)# ldp router id interface loopback 0 force
Qtech(config mpls router)# exit
```

#Configure the public network tunnel between PEs.

```
Qtech(config)# interface gigabitEthernet 0/1
Qtech(config if GigabitEthernet 0/1)# ip ref
Qtech(config if GigabitEthernet 0/1)# ip address 20.20.20.1 255.255.255.0
Qtech(config if GigabitEthernet 0/1)# mpls ip
Qtech(config if GigabitEthernet 0/1)# label switching
Qtech(config if GigabitEthernet 0/1)# exit
```

Configure the L2VPN address family.

```
Qtech(config)# router bgp 100
Qtech(config router)# neighbor 10.10.10.3 remote as 100
Qtech(config router)# neighbor 10.10.10.3 update source loopback 0
Ruiije(config router)# address family l2vpn vpws
Qtech(config router af)# neighbor 10.10.10.3 activate
Qtech(config router af)# neighbor 10.10.10.3 send community extended
Qtech(config router af)# exit
```

Configure VFI instance.

```
Qtech# configure terminal
Qtech(config)# l2 vfi vpws 1 vpnid 1 point to point
Qtech(config vfi)# rd 1:1
Qtech(config vfi)# encapsulation mpls ethernet
```

```

Qttech(config vfi)# route target both 10000:1
Qttech(config vfi)# site id 1
Qttech(config vfi site)# xconnect interface gigabitEthernet 0/3 remote ce id 2
Qttech(config vfi site)#exit site mode
Qttech(config vfi)#exit

```

Configure the interface to connect with remote CEs.

```

Qttech(config)# interface gigabitEthernet 0/3
Qttech(config if GigabitEthernet 0/3)# ip ref
Qttech(config if GigabitEthernet 0/3)# exit

```

Configuring P:

Configure the public network route protocol and LSP tunnel.

The configuration process is similar with the fore-mentioned MPLS basic function configuration instance.

Configuring PE2:

It is similar with PE. See the configuration of PE1.

Configuring CE2:

It is similar with CE1. See the configuration of CE1.

2.2.1.35 Connecting CEs to PEs through VLAN

As shown in the following network topology, the interface that connects PEs and CEs is an Ethernet sub-interface, which means CEs are connected to PEs through the Ethernet sub-interface, through which L2VPN service is provided between CE1 and CE2.

Figure 1-30

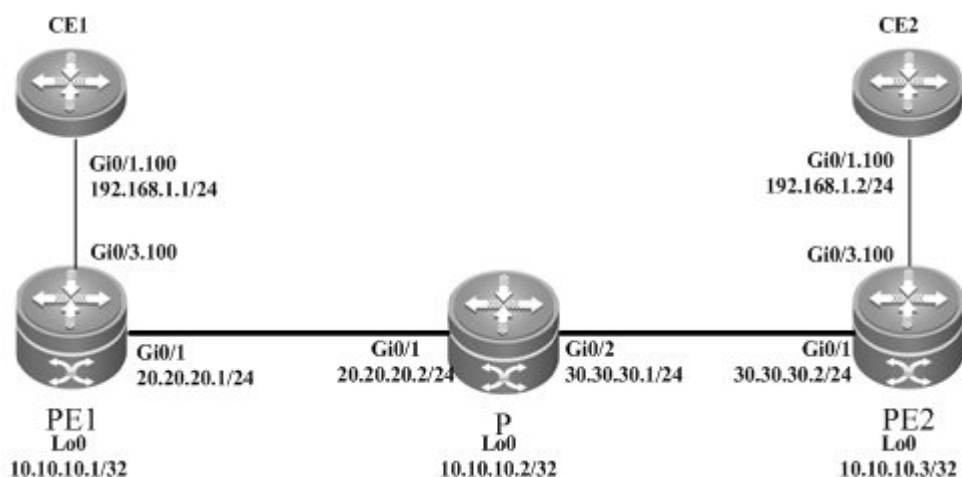

The configuration process is described as follows:

Configuring CE1:

Configure the interface that connects CE1 and PE2.

```
Qtech(config)# interface gigabitethernet 0/1
```

For routers, the fast-forwarding function of routers must be enabled on the interface. Switches do not need to use this command.

```
Qtech(config if gigabitethernet 0/1)# ip ref
Qtech(config if gigabitethernet 0/1)# exit
Qtech(config)# interface gigabitethernet 0/1.100
Qtech(config if Gigabitethernet 0/1.100)# encapsulation dot1Q 100
Qtech(config if Gigabitethernet 0/1.100)# ip address 192.168.1.1 255.255.255.0
Qtech(config if Gigabitethernet 0/1.100)# end
```

Configuring PE1:

Configure Loopback interface address.

```
Qtech(config)# interface loopback 0
Qtech(config if Loopback 0)# ip address 10.10.10.1 255.255.255.255
Qtech(config if Loopback 0)# exit
```

Configure OSPF protocol and establish the public network route.

```
Qtech(config)# router ospf 10
Qtech(config router)# network 10.10.10.1 0.0.0.0 area 0
Qtech(config router)# network 20.20.20.0 0.0.0.255 area 0
Qtech(config router)# exit
```

Configure LDP protocol and enable MPLS globally.

```
Qtech(config)# mpls ip
Qtech(config)# mpls router ldp
Qtech(config mpls router)# ldp router id interface loopback 0 force
Qtech(config mpls router)# exit
```

#Configure the public network tunnel between PEs.

```
Qtech(config)# interface gigabitEthernet 0/1
Qtech(config if Gigabitethernet 0/1)# ip ref
Qtech(config if Gigabitethernet 0/1)# ip address 20.20.20.1 255.255.255.0
Qtech(config if Gigabitethernet 0/1)# mpls ip
Qtech(config if Gigabitethernet 0/1)# label switching
Qtech(config if Gigabitethernet 0/1)# exit
```

Configure the L2VPN address family.

```
Qtech(config)# router bgp 100
Qtech(config router)# neighbor 10.10.10.3 remote as 100
Qtech(config router)# neighbor 10.10.10.3 update source loopback 0
```



```
Ruijie(config router)# address family l2vpn vpws
Qtch(config router af)# neighbor 10.10.10.3 activate
Qtch(config router af)# neighbor 10.10.10.3 send community extended
Qtch(config router af)# exit
```

Configure the interface to connect with remote CEs.

```
Qtch(config if GigabitEthernet 0/3.100)# encapsulation dot1Q 100
Qtch(config if GigabitEthernet 0/3)# exit
```

Configure VFI instance.

```
Qtch# configure terminal
Qtch(config)# l2 vfi vpws 1 vpnid 1 point to point
Qtch(config vfi)# rd 1:1
Qtch(config vfi)# encapsulation mpls ethernetvlan
Qtch(config vfi)# route target both 10000:1
Qtch(config vfi)# site id 1
Qtch(config vfi site)# xconnect interface gigabitEthernet 0/3.100 remote ce id 2
Qtch(config vfi site)#exit site mode
Qtch(config vfi)#exit
```

Configuring P:

Configure the public network route protocol and LSP tunnel.

The configuration process is similar with the fore-mentioned MPLS basic function configuration instance.

Configuring PE2:

It is similar with PE. See the configuration of PE1.

Configuring CE2:

It is similar with CE1. See the configuration of CE1.

2.2.1.36 Option A Inter-AS VPWS

Networking Requirements

- ❖ CE devices of customer S in Site A and Site B are connected with each other through the carrier's PE1 in AS100 and PE2 in AS 200, realizing layer-2 point-to-point connection;
- ❖ PE1 and PE2 are in different autonomous domains. ASBR 1 and ASBR 2 are considered CE devices by each other, which means the interface between ASBRs connects AC to VFI instance;

Topology

Figure 1-31 Kompella VPWS Inter-AS networking topology

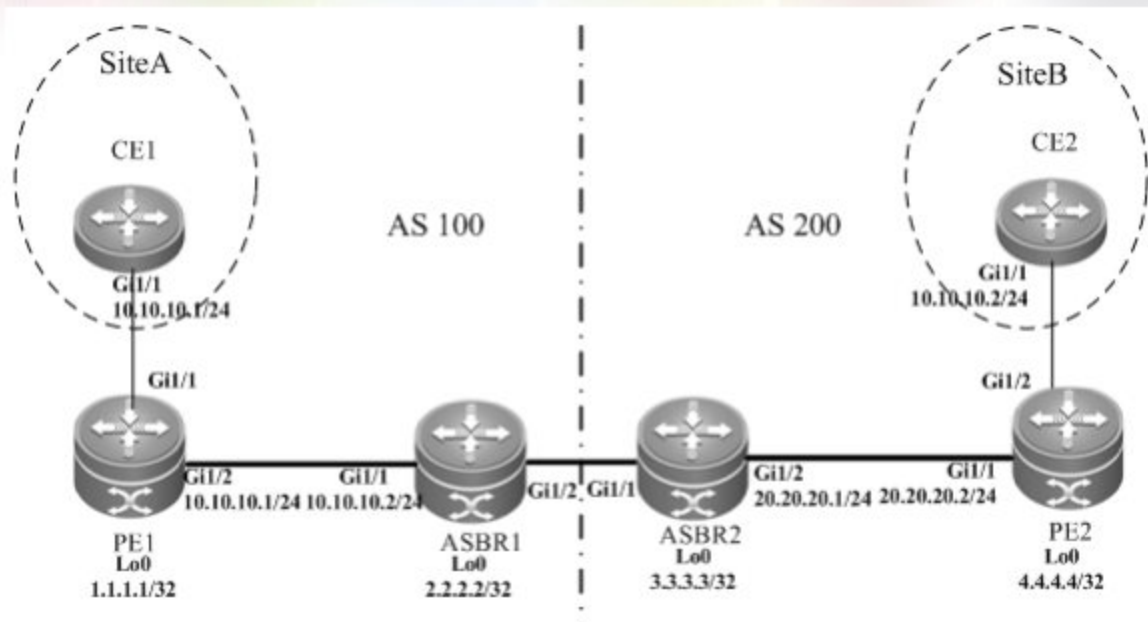

The above figure shows the structure of the Kompella VPLS Inter-AS networking topology in Option A. The intermediate interface is considered by ASBRs as AC access.

Notes

Before configuring Kompella VPWS, complete the following tasks:

- ❖ Run IGP in the carrier's network to realize connection between PE and ASBR devices;
- ❖ Establish MP-IBGP peer relationship between PEs and ASBRs in the domain;
- ❖ Obtain Kompella VPWS configuration information including VPWS instance descriptive information, RT value, CE ID, maximum planned site number, ID deviation and interface from the network administrator.

Configuration Steps

- ❖ Configuring CE1

See "Configuring CE1" in basic configuration examples.

- ❖ Configuring PE1

Configure Loopback interface address.

```
Qtech(config)# interface loopback 0
Qtech(config-if-Loopback 0)# ip address 1.1.1.1 255.255.255.255
Qtech(config-if-Loopback 0)# exit
```

Configure OSPF protocol, establish the public network route so that PEs can ping with ASBRs in the same domain.

```
Qtech(config)# router ospf 10
Qtech(config-router)# network 1.1.1.1 0.0.0.0 area 0
```

```
Qttech(config router)# network 10.10.10.0 0.0.0.255 area 0
Qttech(config router)# exit
```

Configure LDP protocol and enable MPLS globally.

```
Qttech(config)# mpls ip
Qttech(config)# mpls router ldp
Qttech(config mpls router)# ldp router id interface loopback 0 force
Qttech(config mpls router)# exit
```

#Configure the public network tunnel between PEs.

```
Qttech(config)# interface gigabitEthernet 1/2
Qttech(config if GigabitEthernet 1/2)# ip ref
Qttech(config if GigabitEthernet 1/2)# ip address 10.10.10.1 255.255.255.0
Qttech(config if GigabitEthernet 1/2)# mpls ip
Qttech(config if GigabitEthernet 1/2)# label switching
Qttech(config if GigabitEthernet 1/2)# exit
```

Configure the L2VPN address family.

```
Qttech(config)# router bgp 100
Qttech(config router)# neighbor 2.2.2.2 remote as 100
Qttech(config router)# neighbor 2.2.2.2 update source loopback 0
Ruiije(config router)# address family l2vpn vpws
Qttech(config router af)# neighbor 2.2.2.2 activate
Qttech(config router af)# neighbor 2.2.2.2 send community extended
Qttech(config router af)# exit
```

Configure VFI instance.

```
Qttech# configure terminal
Qttech(config)# l2 vfi vpws 1 vpnid 1 point to point
Qttech(config vfi)# rd 100:1
Qttech(config vfi)# encapsulation mpls ethernet
Qttech(config vfi)# route target both 10000:1
Qttech(config vfi)# site id 1
Qttech(config vfi site)# xconnect interface gigabitEthernet 1/1 remote ce id 2
Qttech(config vfi site)#exit site mode
Qttech(config vfi)#exit
```

Configure the CE-PE interface and specify the mote CE ID.

```
Qttech(config)# interface gigabitEthernet 1/1
Qttech(config if GigabitEthernet 1/1)# ip ref
Qttech(config if GigabitEthernet 1/1)# exit
```

❖ Configure ASBR 1

Configure Loopback interface address.

```
Qtech(config)# interface loopback 0
Qtech(config if Loopback 0)# ip address 2.2.2.2 255.255.255.255
Qtech(config if Loopback 0)# exit
```

Configure OSPF protocol, establish the public network route so that PEs can ping with ASBRs in the same domain.

```
Qtech(config)# router ospf 10
Qtech(config router)# network 2.2.2.2 0.0.0.0 area 0
Qtech(config router)# network 10.10.10.0 0.0.0.255 area 0
Qtech(config router)# exit
```

Configure LDP protocol and enable MPLS globally.

```
Qtech(config)# mpls ip
Qtech(config)# mpls router ldp
Qtech(config mpls router)# ldp router id interface loopback 0 force
Qtech(config mpls router)# exit
```

#Configure the public network tunnel between PEs.

```
Qtech(config)# interface gigabitEthernet 1/1
Qtech(config if GigabitEthernet 1/1)# ip ref
Qtech(config if GigabitEthernet 1/1)# ip address 10.10.10.2 255.255.255.0
Qtech(config if GigabitEthernet 1/1)# mpls ip
Qtech(config if GigabitEthernet 1/1)# label switching
Qtech(config if GigabitEthernet 1/1)# exit
```

Configure the L2VPN address family.

```
Qtech(config)# router bgp 100
Qtech(config router)# neighbor 1.1.1.1 remote as 100
Qtech(config router)# neighbor 1.1.1.1 update source loopback 0
Ruijie(config router)# address family l2vpn vpws
Qtech(config router af)# neighbor 1.1.1.1 activate
Qtech(config router af)# exit
```

Configure a VPWS instance.

```
Qtech# configure terminal
Qtech(config)# l2 vfi vpws 1 vpnid 2 point to point
Qtech(config vfi)# rd 100:1
Qtech(config vfi)# encapsulation mpls ethernet
Qtech(config vfi)# route target both 10000:1
Qtech(config vfi)# site id 2
Qtech(config vfi site)# xconnect interface gigabitEthernet 1/2 remote ce id 1
Qtech(config vfi site)#exit site mode
Qtech(config vfi)#exit
```

Configure the interface that connects ASBR 1 and ASBR 2.

```
Qtech(config)# interface gigabitEthernet 1/2
Qtech(config if GigabitEthernet 1/2)# ip ref
Qtech(config if GigabitEthernet 1/2)# exit
```

❖ Configure ASBR 2

Configure Loopback interface address.

```
Qtech(config)# interface loopback 0
Qtech(config if Loopback 0)# ip address 3.3.3.3 255.255.255.255
Qtech(config if Loopback 0)# exit
```

Configure OSPF protocol, establish the public network route so that PEs can ping with ASBRs in the same domain.

```
Qtech(config)# router ospf 10
Qtech(config router)# network 3.3.3.3 0.0.0.0 area 0
Qtech(config router)# network 20.20.20.0 0.0.0.255 area 0
Qtech(config router)# exit
```

Configure LDP protocol and enable MPLS globally.

```
Qtech(config)# mpls ip
Qtech(config)# mpls router ldp
Qtech(config mpls router)# ldp router id interface loopback 0 force
Qtech(config mpls router)# exit
```

#Configure the public network tunnel between PEs.

```
Qtech(config)# interface gigabitEthernet 1/2
Qtech(config if GigabitEthernet 1/2)# ip ref
Qtech(config if GigabitEthernet 1/2)# ip address 20.20.20.2 255.255.255.0
Qtech(config if GigabitEthernet 1/2)# mpls ip
Qtech(config if GigabitEthernet 1/2)# label switching
Qtech(config if GigabitEthernet 1/2)# exit
```

Configure the L2VPN address family.

```
Qtech(config)# router bgp 200
Qtech(config router)# neighbor 4.4.4.4 remote as 200
Qtech(config router)# neighbor 4.4.4.4 update source loopback 0
Ruijie(config router)# address family l2vpn vpws
Qtech(config router af)# neighbor 4.4.4.4 activate
Qtech(config router af)# neighbor 4.4.4.4 send community extended
Qtech(config router af)# exit
```

Configure a VPWS instance.

```
Qtech# configure terminal
Qtech(config)# l2 vfi vpws 1 vpnid 1 point to point
Qtech(config vfi)# rd 200:1
```

```
Qtech(config vfi)# encapsulation mpls ethernet
Qtech(config vfi)# route target both 10000:1
Qtech(config vfi)# site id 3
Qtech(config vfi site)# xconnect interface gigabitEthernet 1/1 remote ce id 4
Qtech(config vfi site)#exit site mode
Qtech Networks(config vfi)#exit
```

Configure the interface that connects ASBR 1 and ASBR 2.

```
Qtech(config)# interface gigabitEthernet 1/1
Qtech(config if GigabitEthernet 1/1)# ip ref
Qtech(config if GigabitEthernet 1/1)# exit
```

❖ Configuring PE2

Configure Loopback interface address.

```
Qtech(config)# interface loopback 0
Qtech(config if Loopback 0)# ip address 4.4.4.4 255.255.255.255
Qtech(config if Loopback 0)# exit
```

Configure OSPF protocol, establish the public network route so that PEs can ping with ASBRs in the same domain.

```
Qtech(config)# router ospf 10
Qtech(config router)# network 4.4.4.4 0.0.0.0 area 0
Qtech(config router)# network 20.20.20.0 0.0.0.255 area 0
Qtech(config router)# exit
```

Configure LDP protocol and enable MPLS globally.

```
Qtech(config)# mpls ip
Qtech(config)# mpls router ldp
Qtech(config mpls router)# ldp router id interface loopback 0 force
Qtech(config mpls router)# exit
```

#Configure the public network tunnel between PEs.

```
Qtech(config)# interface gigabitEthernet 1/1
Qtech(config if GigabitEthernet 1/1)# ip ref
Qtech(config if GigabitEthernet 1/1)# ip address 20.20.20.1 255.255.255.0
Qtech(config if GigabitEthernet 1/1)# mpls ip
Qtech(config if GigabitEthernet 1/1)# label switching
Qtech(config if GigabitEthernet 1/1)# exit
```

Configure the L2VPN address family.

```
Qtech(config)# router bgp 200
Qtech(config router)# neighbor 3.3.3.3 remote as 200
Qtech(config router)# neighbor 3.3.3.3 update source loopback 0
Ruiije(config router)# address family l2vpn vpws
```

```
Qtech(config router af)# neighbor 3.3.3.3 activate
Qtech(config router af)# neighbor 3.3.3.3 send community extended
Qtech(config router af)# exit
```

Configure a VPWS instance.

```
Qtech# configure terminal
Qtech(config)# 12 vfi vpws 1 vpnid 1 autodiscovery
Qtech(config vfi)# rd 200:1
Qtech(config vfi)# signal bgp
Qtech(config vfi)# encapsulation mpls ethernet
Qtech(config vfi)# route target both 10000:1
Qtech(config vfi)# site id 4
Qtech(config vfi site)# xconnect interface gigabitEthernet 1/2 remote ce id 3
Qtech(config vfi site)#exit site mode
Qtech(config vfi)#exit
```

Configure the interface that connects PE 2 and CE.

```
Qtech(config)# interface gigabitEthernet 1/2
Qtech(config if GigabitEthernet 1/2)# ip ref
Qtech(config if GigabitEthernet 1/2)# exit
```

❖ Configuring CE2

See "Configuring CE2" in basic configuration examples.

Displaying verification

After the configuration, CE1 can ping with CE 2.

After completing the configuration of Kompella VPWS, use the following commands to check the operation of VPWS.

Command	Function
Qtech# show bgp l2vpn vpws all	Display all the VPWS information.
Qtech# show mpls l2transport vc [vc_id [ip-address]] [interface interface_name] [detail]	Display information about PW (including VPWS PW and VPLS PW)
Qtech# show bgp l2vpn { vpls vpws } all connections [neighbor address] [interface interface_name] [site-id id] [detail]	Display PW's information.
Qtech# show mpls vfi [name]	Display all the configured or specified VFI information.

2.2.1.37 Option C Inter-AS VPWS

Networking Requirements

- ❖ CE devices of customer S in Site A and Site B are connected with each other through the carrier's PE1 in AS100 and PE2 in AS 200, realizing layer-2 point-to-point connection.

- ❖ PE1 and PE2 are in different autonomous domains and can automatically detect PE devices that join in the VFI instance.
- ❖ ASBR is not responsible for maintaining VPWS label block messages.
- ❖ VPWS label block messages are directly switched between PEs.

Topology

Figure 1-32

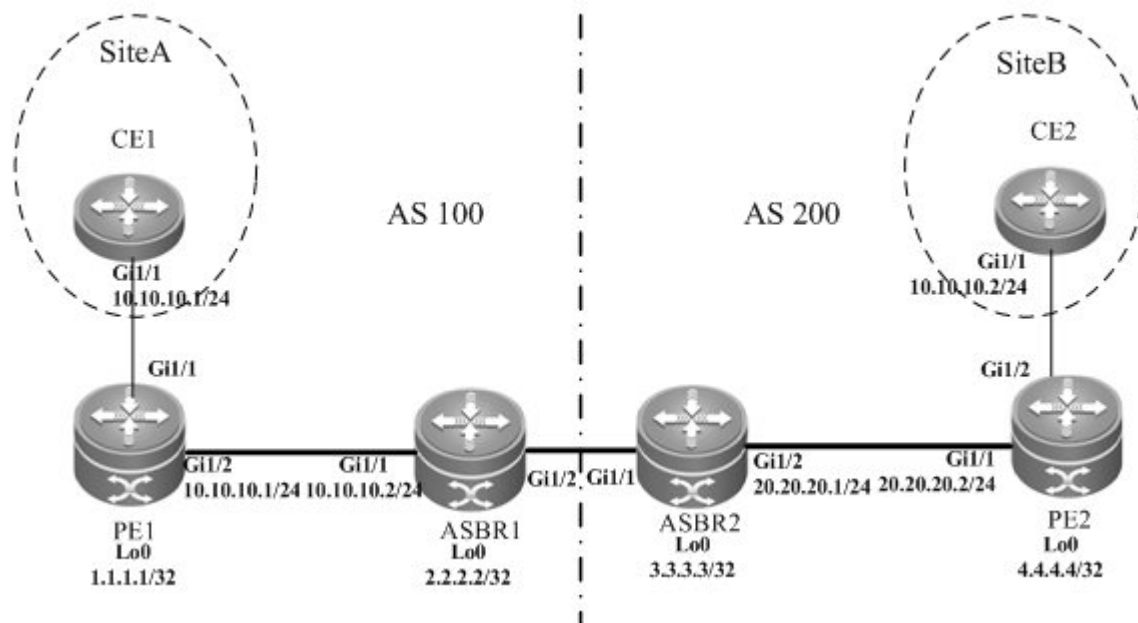

Kompella VPWS Option C Inter-AS networking topology

The above figure shows the structure of Kompella VPWS Option C Inter-AS networking topology. Customer S's CE devices in Site A and Site B are connected to each other through PE1 in AS100 and PE2 in AS200, thus realizing layer-2 point-to-point connection.

Notes

Before configuring Kompella VPWS, complete the following tasks:

- ❖ Run IGP in the carrier's network to realize connection between PE and ASBR devices in the same AS.
- ❖ Establish a public network tunnel between PE and ASBR devices in the same domain and enable MPLS on the ASBR interface.
- ❖ Establish IBGP between PE and ASBR in the same domain.
- ❖ Establish EBGP between ASBR devices and enable send-label.

- ❖ Obtain Kompella VPWS configuration information including VPWS instance descriptive information, RT value, CE, planned site number, ID deviation and interface from the network administrator.

Configuration Steps

- ❖ Configuring CE1

See "Configuring CE1" in basic configuration examples.

- ❖ Configuring PE1

Configure Loopback interface address.

```
Qtech(config)# interface loopback 0
Qtech(config if Loopback 0)# ip address 1.1.1.1 255.255.255.255
Qtech(config if Loopback 0)# exit
```

Configure OSPF protocol and establish the public network route.

```
Qtech(config)# router ospf 10
Qtech(config router)# network 1.1.1.1 0.0.0.0 area 0
Qtech(config router)# network 10.10.10.0 0.0.0.255 area 0
Qtech(config router)# exit
Qtech(config router)# exit
```

Configure LDP protocol and enable MPLS globally.

```
Qtech(config)# mpls ip
Qtech(config)# mpls router ldp
Qtech(config mpls router)# ldp router id interface loopback 0 force
Qtech(config mpls router)# exit
```

#Configure the public network tunnel between PEs.

```
Qtech(config)# interface gigabitEthernet 1/2
Qtech(config if GigabitEthernet 1/2)# ip ref
Qtech(config if GigabitEthernet 1/2)# ip address 10.10.10.1 255.255.255.0
Qtech(config if GigabitEthernet 1/2)# mpls ip
Qtech(config if GigabitEthernet 1/2)# label switching
Qtech(config if GigabitEthernet 1/2)# exit
```

Configure the L2VPN address family.

```
Qtech(config)# router bgp 100
Qtech(config router)# neighbor 4.4.4.4 remote as 200
Qtech(config router)# neighbor 4.4.4.4 update source loopback 0
Qtech(config router)# neighbor 4.4.4.4 ebgp multihop
Qtech(config router)# address family ipv4
Qtech(config router af)# no neighbor 4.4.4.4 activate
Qtech(config router af)# exit
```

```
Ruijie(config router)# address family l2vpn vpws
Qttech(config router af)# neighbor 4.4.4.4 activate
Qttech(config router af)# neighbor 4.4.4.4 send community extended
Qttech(config router af)# exit
```

Configure a VPWS instance.

```
Qttech# configure terminal
Qttech(config)# l2 vfi vpws 1 vpnid 1 point to point
Qttech(config vfi)# rd 100:1
Qttech(config vfi)# encapsulation mpls ethernet
Qttech(config vfi)# route target both 10000:1
Qttech(config vfi)# site id 1
Qttech(config vfi site)# xconnect interface gigabitEthernet 1/1 remote ce id 2
Qttech(config vfi site)#exit site mode
Qttech(config vfi)#exit
```

Configure the interface that connects CEs.

```
Qttech(config)# interface gigabitEthernet 1/1
Qttech(config if GigabitEthernet 1/1)# ip ref
Qttech(config if GigabitEthernet 1/1)# exit
```

❖ Configure ASBR 1

Configure Loopback interface address.

```
Qttech(config)# interface loopback 0
Qttech(config if Loopback 0)# ip address 2.2.2.2 255.255.255.255
Qttech(config if Loopback 0)# exit
```

Configure OSPF protocol and establish the public network route.

```
Qttech(config)# router ospf 10
Qttech(config router)# redistribute bgp subnets
Qttech(config router)# network 2.2.2.2 0.0.0.0 area 0
Qttech(config router)# network 10.10.10.0 0.0.0.255 area 0
Qttech(config router)# exit
```

Configure LDP protocol and enable MPLS globally.

```
Qttech(config)# mpls ip
Qttech(config)# mpls router ldp
Qttech(config mpls router)# ldp router id interface loopback 0 force
Qttech(config mpls router)# advertise labels for bgp routes
Qttech(config mpls router)# exit
```

#Configure the public network tunnel between PEs.

```
Qttech(config)# interface gigabitEthernet 1/1
Qttech(config if GigabitEthernet 1/1)# ip ref
```

```
Qtech(config if GigabitEthernet 1/1)# ip address 10.10.10.2 255.255.255.0
Qtech(config if GigabitEthernet 1/1)# mpls ip
Qtech(config if GigabitEthernet 1/1)# label switching
Qtech(config if GigabitEthernet 1/1)# exit
```

Configure the interface that connects ASBR.

```
Qtech(config)# interface gigabitEthernet 1/2
Qtech(config if GigabitEthernet 1/2)# ip ref
Qtech(config if GigabitEthernet 1/2)# ip address 192.168.1.1 255.255.255.252
Qtech(config if GigabitEthernet 1/2)# label switching
Qtech(config if GigabitEthernet 1/2)# exit
```

Configure ASBR to allocate labels for PEs' routes.

```
Qtech(config)# router bgp 100
Qtech(config router)# neighbor 192.168.1.2 remote as 200
Qtech(config router)# address family ipv4
Qtech(config router af)# neighbor 192.168.1.2 send label
Qtech(config router af)# network 1.1.1.1 mask 255.255.255.255
Qtech(config router af)# end
```

❖ Configure ASBR 2

Configure Loopback interface address.

```
Qtech(config)# interface loopback 0
Qtech(config if Loopback 0)# ip address 3.3.3.3 255.255.255.255
Qtech(config if Loopback 0)# exit
```

Configure OSPF protocol and establish the public network route.

```
Qtech(config)# router ospf 20
Qtech(config router)# redistribute bgp subnets
Qtech(config router)# network 3.3.3.3 0.0.0.0 area 0
Qtech(config router)# network 20.20.20.0 0.0.0.255 area 0
Qtech(config router)# exit
```

Configure LDP protocol and enable MPLS globally.

```
Qtech(config)# mpls ip
Qtech(config)# mpls router ldp
Qtech(config mpls router)# ldp router id interface loopback 0 force
Qtech(config mpls router)# advertise labels for bgp routes
Qtech(config mpls router)# exit
```

#Configure the public network tunnel between PEs.

```
Qtech(config)# interface gigabitEthernet 1/2
Qtech(config if GigabitEthernet 1/2)# ip ref
Qtech(config if GigabitEthernet 1/2)# ip address 20.20.20.2 255.255.255.0
```

```
Qtech(config if GigabitEthernet 1/2)# mpls ip
Qtech(config if GigabitEthernet 1/2)# label switching
Qtech(config if GigabitEthernet 1/2)# exit
```

Configure the interface that connects ASBR.

```
Qtech(config)# interface gigabitEthernet 1/1
Qtech(config if GigabitEthernet 1/1)# ip ref
Qtech(config if GigabitEthernet 1/1)# ip address 192.168.1.1 255.255.255.252
Qtech(config if GigabitEthernet 1/1)# label switching
Qtech(config if GigabitEthernet 1/1)# exit
```

Configure ASBR to allocate labels for PEs' routes.

```
Qtech(config)# router bgp 200
Qtech(config router)# neighbor 192.168.1.1 remote as 100
Qtech(config router)# address family ipv4
Qtech(config router af)# neighbor 192.168.1.1 send label
Qtech(config router af)# network 4.4.4.4 mask 255.255.255.255
Qtech(config router af)# end
```

❖ Configuring PE2

Configure Loopback interface address.

```
Qtech(config)# interface loopback 0
Qtech(config if Loopback 0)# ip address 4.4.4.4 255.255.255.255
Qtech(config if Loopback 0)# exit
```

Configure OSPF protocol and establish the public network route.

```
Qtech(config)# router ospf 20
Qtech(config router)# network 4.4.4.4 0.0.0.0 area 0
Qtech(config router)# network 20.20.20.0 0.0.0.255 area 0
Qtech(config router)# exit
```

Configure LDP protocol and enable MPLS globally.

```
Qtech(config)# mpls ip
Qtech(config)# mpls router ldp
Qtech(config mpls router)# ldp router id interface loopback 0 force
Qtech(config mpls router)# exit
```

#Configure the public network tunnel between PEs.

```
Qtech(config)# interface gigabitEthernet 1/1
Qtech(config if GigabitEthernet 1/1)# ip ref
Qtech(config if GigabitEthernet 1/1)# ip address 20.20.20.1 255.255.255.0
Qtech(config if GigabitEthernet 1/1)# mpls ip
Qtech(config if GigabitEthernet 1/1)# label switching
```

```
Qtech(config if GigabitEthernet 1/1)# exit
```

Configure the L2VPN address family.

```
Qtech(config)# router bgp 100
Qtech(config router)# neighbor 1.1.1.1 remote as 100
Qtech(config router)# neighbor 1.1.1.1 update source loopback 0
Qtech(config router)# neighbor 1.1.1.1 ebgp multihop
Qtech(config router)# address family ipv4
Qtech(config router af)# no neighbor 1.1.1.1 activate
Qtech(config router af)# exit
Ruiije(config router)# address family l2vpn vpws
Qtech(config router af)# neighbor 1.1.1.1 activate
Qtech(config router af)# neighbor 1.1.1.1 send community extended
Qtech(config router af)# exit
```

Configure a Kompella VPWS instance.

```
Qtech# configure terminal
Qtech(config)# l2 vfi vpws 1 vpnid 1 point to point
Qtech(config vfi)# rd 200:1
Qtech(config vfi)# encapsulation mpls ethernet
Qtech(config vfi)# route target both 10000:1
Qtech(config vfi)# mtu 1500
Qtech(config vfi)# site id 2
Qtech(config vfi site)# xconnect interface gigabitEthernet 1/2 remote ce id 1
Qtech(config vfi site)#exit site mode
Qtech(config vfi)#exit
```

Configure the interface that connects PEs and CEs.

```
Qtech(config)# interface gigabitEthernet 1/2
Qtech(config if GigabitEthernet 1/2)# ip ref
Qtech(config if GigabitEthernet 1/2)# exit
```

❖ Configuring CE2

See "Configuring CE2" in basic configuration examples.

Displaying verification

After the configuration, CE1 can ping with CE 2.

After completing the configuration of Kompella VPLS, use the following commands to check the operation of VPWS.

Command	Function
Qtech# show bgp l2vpn vpws all	Display all the VPWS information.
Qtech# show mpls l2transport vc [vc_id [ip-address]] [interface interface_name] [detail]	Display information about PW (including VPWS PW and VPLS PW)

Qtech# show bgp l2vpn { vpls vpws } all connections [neighbor <i>address</i>] [interface <i>interface_name</i>] [site-id <i>id</i>] [detail]	Display PW's information.
Qtech# show mpls vfi [<i>name</i>]	Display all the configured or specified VFI information.

2.3 Configuring VPLS

2.3.1 Introduction

The Virtual Private LAN Service (VPLS) is a technology that provides virtual and dedicated Ethernet services on an IP/MPLS network. By using VPLS, you can set up PWs in full mesh mode between PEs to forward encapsulated Layer 2 Ethernet frames between the PEs on the MPLS network. In this manner, you can create a P2MP Ethernet VPN. With a VPLS VPN, the user Layer 2 devices are connected to each other across the IP/MPLS core network and the core network is like a virtual switch for the user.

Compared with VPWS, VPLS can provide P2MP solutions. Compared with L3VPN, VPLS has the advantages of L2VPN to provide better network scalability and maintenance.

The terms used in this document are as follows:

- ❖ PW: Pseudo Wire
- ❖ VPLS: Virtual Private LAN Service
- ❖ H-VPLS: Hierarchical VPLS
- ❖ MTU: Multi-Tenant Unit indicates corporate users at office buildings and business districts.
- ❖ As small edge devices at gathering places, the MTU is responsible for accessing corporate customers and aggregating users who require VPLS services to a PE through VCs.
- ❖ Spoke Connection: indicates the connection of a U-PE to an N-PE in H-VPLS. You can use a PW or VLAN stack (also called QinQ).
- ❖ Spoke PW: indicates the Spoke connection between an N-PE and a U-PE when a PW is adopted, or the PW between a CE and PE when a user accesses the CE through PWs.

2.3.1.1 Network Structure

Basic VPLS

The following figure shows a typical VPLS model.

Figure 1-33

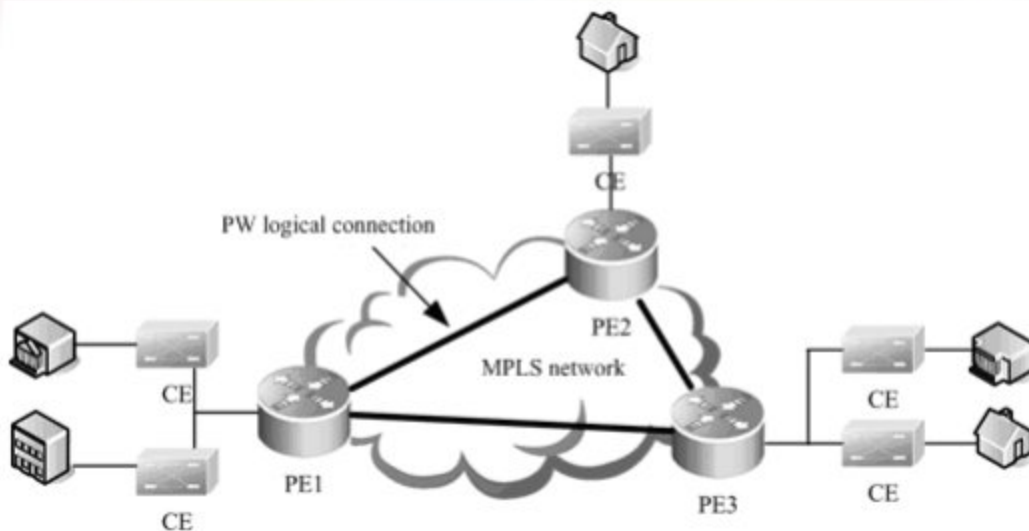

As shown in the VPLS networking in the preceding figure, PW logical connections are set up between PEs and the CEs are connected to the PEs enabled with VPLS. These VPLS PEs form P2MP services for the CEs. In this manner, the PEs are like a Layer 2 switch to the CEs.

The VPLS model in Figure 21 has the following defects:

- ❖ To avoid loops, packets forwarded on the PWs between PEs are horizontally partitioned. That is, the packets received from a Hub PW are not forwarded to the Hub PW any longer. Therefore, PWs must be set up between every two PEs. This incurs large system overheads and is not applicable to networks of large scales.
- ❖ The broadcast and multicast packets should be replicated at every PW, leading to low efficiency.

To address these problems, the hierarchical VPLS is introduced.

Hierarchical VPLS

The following figure shows a typical hierarchical VPLS (H-VPLS) model.

Figure 1-34

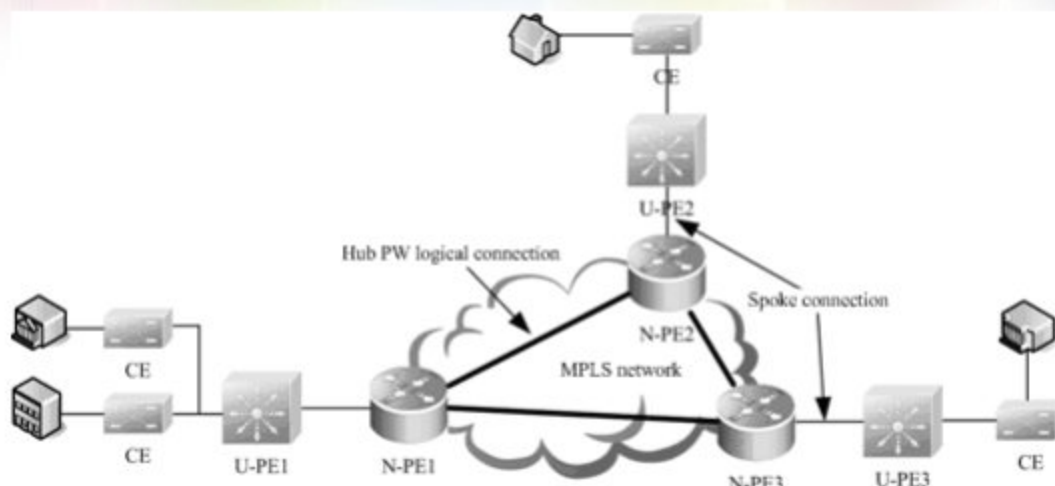

H-VPLS classifies the VPLS network into layers and set up Hub PWs only between N-PEs on the core network. This addresses the defect on a common VPLS network. The Spoke connections between U-PEs and N-PEs are formed through PWs or QinQ tunnels. The U-PE is not required to support VPLS. Instead, the U-PE can support VPWS or QinQ.

With H-VPLS, you can reduce the burden on the VPLS core devices, decrease the overheads of the signaling protocol, reduce the number of packets that are replicated, and greatly strengthen the scalability of the VPLS network.

2.3.1.2 Signaling Protocol

VPLSs can be divided into Martini and Kompella VPLSs according to different VPLS signaling protocols. The two signals are defined respectively in RFC4762 and RFC4761 of IETF. The Martini VPLS is based on the LDP signaling protocol and Kompella VPLS is based on the BGP signaling protocol. Given the BGP protocol's characteristics, such as the route reflector's characteristics, the method of setting up VPLS can reduce the full inter-connection of BGP sessions, thus facilitating the expansion of capacity. In contrast, the Martini VPLS applies to small-sized and simple environment deployment.

2.3.1.3 VPLS Inter-AS

Both Martini and Kompella VPLSs can be Inter-AS through Option A solution. In the Inter-AS VPLS networking environment, the type of link between ASBRs must be the same as the type of VC. The shortcoming of the solution is that a sub-interface must be prepared for each Inter-AS VC on ASBR. This solution can be adopted when the number of Inter-AS VCs is small.

Option C is another solution to realize Inter-AS VPLS. The SP network device only needs external tunnels on PEs in different ASs. ASBR does not maintain Inter-AS VPLS information and does not need to prepare an interface for the Inter-AS VPLS. VSI information of the VPLS can only be switched between PEs, thus saving resources without adding configuration tasks. The solution applies when the number of Inter-AS VPLSs is large.

2.3.2 Configuring Martini VPLS

2.3.2.1 Configuring a Public Tunnel Between PEs

You must set up an LSP on the public network to carry VPLS services. To run MPLS on the backbone network, you must enable LDP on P and PEs at the same time to set up a public tunnel. This means that you have to configure LDP on MPLS devices and enable MPLS on each interface. The configuration procedure is as follows:

Command	Function
Qtech# config terminal	Enter the global configuration mode.
Qtech (config)# mpls ip	Enable MPLS globally. <input checked="" type="checkbox"/> This command is inapplicable for switch chip forwarding.
Qtech (config)# mpls router ldp	Enable LDP and enter the LDP configuration mode.
Qtech (config-mpls-router)# ldp router-id interface loopback id [force]	Configure the LDP router ID. The IP address of the loopback interface is generally used as the router ID.
Qtech (config-mpls-router)# exit	Quit the LDP configuration mode.
Qtech (config)# interface type ID	Enter the public interface configuration mode.
Qtech (config-if-type ID)# label-switching	Enable MPLS on the interface at the public network side.
Qtech (config-if-type ID)# mpls ip	Enable LDP and MPLS forwarding for the interface.
Qtech (config-if-type ID)# ip ref	The interface's fast-forwarding function must be enabled for routers.
Qtech (config-if-type ID)# end	Return to the privilege mode.
Qtech# copy running-config startup-config	Save the configuration.



Note

The LDP is a topology-driven protocol. To ensure the normal working of the LDP, you should enable IPv4 routing protocols and ensure their normal operations.

2.3.2.2 Configuring Remote LDP Peers

The setup and maintenance of a PW is completed by the extended LDP. If other LSRs exist between two PEs, you should adopt the extended LDP discovery mechanism to set up a remote LDP session between the PEs and assign PW labels in the session. The procedures for configuring a remote LDP peer and setting up a remote LDP session are as follows:

Command	Function
Qtech# config terminal	Enter the global configuration mode.
Qtech (config)# mpls router ldp	Enable LDP and enter the LDP configuration mode.
Qtech (config-mpls-router)# neighbor ip_address	Configure remote LDP peers.
Qtech (config-mpls-router)# exit	Quit the LDP configuration mode.
Qtech (config)# end	Return to the privilege mode.
Qtech# copy running-config startup-config	Save the configuration.



Note The PW label messages of the LDP are not affected by the LDP label distribution mode or label retention mode. The LDP works in the DU and liberal label retention mode.

2.3.2.3 Example for Configuring Martini VPLS

The **I2 vfi** command is used to create a VPLS instance and enter the VPLS mode. The **no I2 vfi** command deletes a VPLS instance. When you create a VPLS instance, you must specify a name that is unique on the local device and specify a unique VPN ID. The VPLS names and VPN IDs form one-to-one relations.

Command	Function
Qtech# config terminal	Enter the global configuration mode.
Qtech (config)# I2 vfi vpls-name vpnid vpn-id	Create a VPLS instance and enter the VPLS configuration mode.
Qtech (config-vfi)# neighbor ip-address encapsulation mpls [vc-id vc-id] [hub-vc spoke-vc] [ethernet ethernetvlan]	Configure a VPLS peer. The default PW type is ethernet. We recommend using the PW type for access interface access and VLAN tunnel port access and routers' Ethernet interface access. <input checked="" type="checkbox"/> We recommend setting PW as the ethernetvlan type if switchers use Trunk interface access or routers use sub-interface access VPLS service.
Qtech (config-vpls)# end	Return to the privilege mode.
Qtech# copy running-config startup-config	Save the configuration.



Note The VPLS peer must be unique in the VPLS instance scope. To facilitate management, VPLS instances of one VPN should be configured with the same ID.



Note PW's key is the PW ID and VPLS peer's LSR ID. It must be unique globally, including VPWS PW.



Note Each configuration of the same peer by using the neighbor command will cover the previous one.



Note The MTU parameter and PW type of interfaces on two ends of a PW must be the same. The default PW type of the VPLS is Ethernet. PW IDs on two ends of PEs, the VC IDs, must be the same.



Note To use the **neighbor** command to specify the address of the VC's peer neighbor, the peer Router ID must be applied as the peer address, and the peer Router ID must be the 32-bit address of the Loopback interface.

For switches, dhcp packets cannot be transmitted transparently after ip dhcp snooping is enabled globally.

2.3.2.4 Configuring User Access VPLS

For switches, each VPLS can only bind one interface. For routers, multiple interfaces can be bound.

Configuring VPLS access mode for switches

A VPLS instance takes effect only after the user of the VPLS instance accesses the VPLS. At present, there are three modes of user access VPLS services:

For switches, as VPLS is only supported by the SVI interface, a VPLS can only bind one SVI interface.



Note When the port protection mode is enabled on the AC-end member port of L2VPN, if the corresponding member port is not a Trunk interface, the port protection mode will not take effect on the member port.

❖ VLAN Access Interface Access

The VLAN access interface is applicable to the transmission of user packets that are not encapsulated through 802.1q (that is, packets without VLAN tags) on VPLS ACs.

Command	Function
Qtech# config terminal	Enter the global configuration mode.
Qtech (config)# interface type ID	Enter the interface mode of the specified physical interface.
Qtech (config-if-type ID)# switchport mode access	Set the interface to work in access mode.
Qtech (config-if-type ID)# switchport access vlan-id	Set the interface as a VLAN member interface.
Qtech (config-if-type ID)# exit	Quit the interface configuration mode.
Qtech (config)# interface vlan vlan-id	Enter the VLAN interface mode.
Qtech (config-if-type ID)# xconnect vfi vpls-name	Bind the VLAN to a VPLS instance.
Qtech (config-if-type ID)# end	Return to the privilege mode.
Qtech# copy running-config startup-config	Save the configuration.



Note For the access port access mode, we recommend setting the PW type as **Ethernet**, and the two ends of PW must be set in the same type.

❖ VLAN Trunk Interface Access

The VLAN trunk interface access is applicable to the transmission of multiple VPLS services on the same physical AC. Each VLAN corresponds to one VPLS instance. The PE determines the VPLS instance for user packets based on their VLAN tags and provides the multiplexing of access interfaces.

Command	Function
Qtech# config terminal	Enter the global configuration mode.
Qtech (config)# interface <i>type ID</i>	Enter the interface mode of the specified physical interface.
Qtech (config-if- <i>type ID</i>)# switchport mode trunk	Set the interface to work in trunk mode.
Qtech (config-if- <i>type ID</i>)# switchport trunk allow vlan <i>vlan-list</i>	Set the trunk link to allow VLAN traffic.
Qtech (config-if- <i>type ID</i>)# exit	Quit the interface configuration mode.
Qtech (config)# interface vlan <i>vlan-id</i>	Enter the VLAN interface mode.
Qtech (config-if- <i>type ID</i>)# xconnect vfi <i>vpls-name</i>	Bind the VLAN to a VPLS instance.
Qtech (config-if- <i>type ID</i>)# end	Return to the privilege mode.
Qtech# copy running-config startup-config	Save the configuration.



Note For the Trunk interface access mode, we recommend setting the PW type as **ethernetvlan**, and the two ends of PW must be set in the same type.



Note The L2 VPN service cannot be bound to the Native VLAN of the Trunk interface.

❖ VLAN Tunnel Interface Access

The VLAN tunnel interface access is applicable to the transmission of user service packets that carry private VLAN tags on the ACs when a user accesses VPLS services. In this mode, the PE forwards all packets received from the VLAN tunnel interface without any changes. This mode requires the VLAN member interfaces that connect PEs and CEs to work in tunnel mode.

Command	Function
Qtech# config terminal	Enter the global configuration mode.
Qtech (config)# interface <i>type ID</i>	Enter the interface mode of the specified physical interface.
Qtech (config-if- <i>type ID</i>)# switchport access <i>vlan-id</i>	Set the interface as a VLAN member interface.
Qtech (config-if- <i>type ID</i>)# switchport mode dot1q-tunnel	Set the interface to work in tunnel mode.
Qtech (config-if- <i>type ID</i>)# exit	Quit the interface configuration mode.
Qtech (config)# interface vlan <i>vlan-id</i>	Enter the VLAN interface mode.
Qtech (config-if- <i>type ID</i>)# xconnect vfi <i>vpls-name</i>	Bind the VLAN to a VPLS instance.
Qtech (config-if- <i>type ID</i>)# end	Return to the privilege mode.

Qtech# copy running-config startup-config	Save the configuration.
--	-------------------------



Note For the VLAN tunnel port access mode, we recommend setting the PW type as **Ethernet**, and the two ends of PW must be set in the same type.



Note For the VLAN tunnel port access mode, only the basic QinQ is supported, and flexible QinQ is not supported.

❖ PW access

The PW access is applicable to user access networks that are enabled with MPLS. In addition, the user is not directly connected to any VPLS PE link. You can also configure the U-PE to provide users with VPLS access services in an H-VPLS model if the U-PE does not serve as a bridge. In this case, the PW is connected to the N-PE from the U-PE.

Command	Function
Qtech# config terminal	Enter the global configuration mode.
Qtech (config)# l2 vfi name	Enter the VPLS configuration mode.
Qtech (config-vpls)# neighbor ip-address encapsulation mpls [vc-id vc-id] spoke-vc [ethernet ethernetvlan]	Configure a PW for user access.
Qtech (config-vpls)# end	Return to the privilege mode.
Qtech# copy running-config startup-config	Save the configuration.

For one VPLS instance, you can configure multiple user access PWs.



Note When you access VPLS services through PWs, you must specify the **spoke-vc** keyword in the **neighbor** command to configure PWs. When the **label-switching** command must be enabled on the Spoke PW access interface and fast-forwarding must be enabled for the router.

Configuring VPLS access mode for routers

A created VPLS instance will only take effect after the user configured with the VPLS instance is connected with the link.

❖ Ethernet interface access

The Ethernet interface access mode applies when users access the VPLS service, the user service packets transmitted on the access link carry private Vlan tags or do not carry Vlan tags. In this mode, all packets received by PE from the interface will be forwarded according to the destination MAC and the private tags are considered part of the data. In such case, PE provides port-based

VPLS service. The address learning mode of the VPLS instance of the bound port is the free mode. MAC address overlapping in the user VLAN is not supported.

Command	Function
Qtech# config terminal	Enter the global configuration mode.
Qtech (config)# interface <i>type ID</i>	Enter the specified physical interface.
Qtech (config-if-type ID)# ip ref	The interface's fast-forwarding function must be enabled for routers.
Qtech (config-if-type ID)# xconnect vfi <i>vpls-name</i>	Bind VLAN to the VPLS instance.
Qtech (config-if-type ID)# end	Return to the privileged mode.
Qtech# copy running-config startup-config	Save configuration.



Note For the VPLS service of the Ethernet interface access mode, we recommend setting the PW's type as **ethernet** and both ends of the PW in the same PW type.



Note The same VPLS instance can be bound to different interfaces to realize local connection.



Note If a VPLS instance is configured on different PEs with Ethernet interface and sub-interface access modes, we recommend setting all PWs of the VPLS instance in the **ethernetvlan** type.

❖ Sub-interface access

The access mode applies when multiple VPLS services are transmitted on a physical access link. Each sub-interface corresponds with a VPLS instance. PE devices can match packets with VPLS instances according to VLAN tags carried by the user packets, and provide the access port multiplier mode.

Command	Function
Qtech# config terminal	Enter the global configuration mode.
Qtech (config)# interface <i>type ID</i>	Enter the specified physical interface.
Qtech (config-if-type ID)# encapsulation dot1Q	Set the VIP encapsulated by the sub-interface.
Qtech (config-if-type ID)# ip ref	The interface's fast-forwarding function must be enabled for routers.
Qtech (config-if-type ID)# xconnect vfi <i>vpls-name</i>	Bind VLAN to the VPLS instance.
Qtech (config-if-type ID)# end	Return to the privileged mode.
Qtech# copy running-config startup-config	Save configuration.



Note If a VPLS instance is used to transmit flows of multiple VLANs of the user, MAC address overlapping between VLANs of the user is not supported.



Note The same VPLS instance can be bound to different interfaces to realize local connection.



Note For the VPLS service of the sub-interface access mode, we recommend setting the PW's type as **ethernetvlan** and both ends of the PW in the same PW type.

❖ PW access

The mode applies when the user's access network is the MPLS network and no direct link is set up between the user and VPLS PEs. In the H-VPLS mode, the PW access mode can be used to access N-PE when U-PE has no bridging capability so that the VPLS access service can be provided on U-PE for the user.

Command	Function
Qtech# config terminal	Enter the global configuration mode.
Qtech (config)# I2 vfi name	Enter the VPLS configuration mode.
Qtech (config-vfi)# neighbor ip-address encapsulation mpls [vc-id vc-id] spoke-vc [ethernet ethernetvlan]	Configuring the PW to be accessed by user.
Qtech (config-vfi)# end	Return to the privileged mode.
Qtech# copy running-config startup-config	Save configuration.



Note One VPLS instance can be configured with multiple user access PWs.



Note When you access VPLS services through PWs, you must specify the **spoke-vc** keyword in the **neighbor** command to configure PWs.

For routers, the **label-switching** and **ip ref** commands must be enabled on the interface where Spoke PW is located.



Note If the Ethernet access mode is adopted, the PW type must be **ethernet**. If the Ethernet sub-interface access mode is adopted, the PW type must be **ethernetvlan**.

2.3.2.5 Showing MPLS REF Entries

To display MPLS REF entries, use the following commands in the privileged EXEC mode.

Command	Function
show mpls ref vc [summary <i>vc_id</i> [detail] vpls <i>vpls_id</i> [detail]]	Display the VC entry related to MPLS REF. summary : displays brief information. <i>vc_id</i> : displays the specified VC entry. <i>vpls_id</i> :displays all VC entries of the VPLS to be displayed. detail : displays detailed information.
show mpls ref vpls [summary <i>id</i> [detail] name <i>name</i> [detail]]	Display the VPLS entry related to MPLS REF. summary : displays brief information. <i>id</i> :displays ID of VPLS instances. <i>name</i> : displays name of VPLS instances. detail : displays detailed information.
show mpls ref vpls-mac <i>id</i> [<i>mac-address</i>]	Display the MAC address of the VPLS instance related to MPLS REF. <i>id</i> : ID of VPLS instances <i>mac-address</i> : MAC address

The following example displays the VC entry of MPLS REF.

```
Qttech#showmpls ref vc
Flags: *   enable fwd
VC ID      VC Type      In Label Out Label Owner Type VPLS ID  Intf      Port      Peer
*1         eth           0        111      hub      1       na       0        2.2.2.2
```

The following example displays the details of VPLS instance.

```
Qttech#show mpls ref vpls id 1 detail
MPLSREF VPLS Instance Detail:
vpls_id: 1
vpls_name: vpls
mac_aging_time: 300 seconds
mac_thresh: 256
mac_lim_alarm_enable: 0
mac_lim_alarm_raised: 0
mac_lim_fwd_enable: 0
mtu: 1500
interfaces: 1
  GigabitEthernet 0/2 (ifx=4), encap_vid=0
hub pw: 1
  1          2.2.2.2
spoke pw: 0
static mac: 0
```



```
total mac: 4
```

The following example displays the MAC address of a VPLS instance.

```
Qtech#show mpls ref vpls mac 1
VPLS vpls (1) MAC entries:
Flags: s    static
Mac address      Age(sec)   Vc/Intf

6c:62:6d:d5:96:b6 0           GigabitEthernet 0/2 (ifx=4)
00:d0:f8:fb:b8:81 0           GigabitEthernet 0/2 (ifx=4)
00:d0:f8:22:66:77 127        GigabitEthernet 0/2 (ifx=4)
00:d0:f8:fb:b6:81 0           GigabitEthernet 0/2 (ifx=4)
```

2.3.2.6 Displaying MAC Address for VPLS Instance

Switches do not support the forwarding statistics function.

To display all the MAC addresses of a VPLS instance, use the following command in the privileged EXEC mode.

Command	Function
show ip ref mpls forwarding-table vfi [<i>vpls_name</i>] [mac-address-table [<i>H.H.H</i>] [static] [dynamic]	Display all the MAC addresses of a VPLS instance. <i>vpls_name</i> : VPLS instance name mac-address-table <i>H.H.H</i> : Displays the specified MAC address. static : Displays the static MAC address. dynamic : Displays the dynamic MAC address.

The following example displays MAC addresses of a VPLS instance.

```
Qtech#showip ref mpls forwarding table vfi vpls_a mac address table
aging time : 300
total number of addresses : 2
mac limit action : discard

MAC Address    VC Label  Peer Address    Type  Interface
0000.b000.0001 1024      2.2.2.2         D     D
0000.a000.0001                D     GigabitEthernet 3/5
```

2.3.2.7 Verifying Martini VPLS Configuration

After completing the configuration of the VPLS, use the following commands to check the operation of VPLS.

Command	Function
Qtech# show mpls vfi	Display VPLS information.
Qtech# show mpls l2transport vc [[<i>vc_id</i> [<i>ip-address</i>]] [[interface <i>interface-name</i>]] [detail]	Display information about PW (including VPWS PW and VPLS PW)

Qtech# show mpls forwarding-table	Display PW-related ILM and FTN forwarding table entries.
Qtech# show mpls ldp neighbor	Display all ldp neighbor information.
Qtech# show mpls ldp vc	Display all ldp vc information.

2.3.3 Configuring Kompella VPLS

2.3.3.1 Configuring the public network tunnel between PEs

The LSP tunnel must be set up in the public network to provide the VPLS service. To run MPLS in the backbone network, the LDP protocol must be run on P and PE to establish the public network tunnel. This includes configuring the label allocation protocol for MPLS devices and enabling the MPLS forwarding on each interface. The configuration process is described as follows:

Command	Function
Qtech# config terminal	Enter the global configuration mode.
Qtech# mpls ip	Enable MPLS forwarding globally.  Caution This command is inapplicable for switch chip forwarding.
Qtech (config)# mpls router ldp	Enable LDP and enter the LDP configuration mode.
Qtech (config-mpls-router)# ldp router-id interface loopback id [force]	Configure LDP's Router ID, which is usually the IP address of the Loopback interface.
Qtech (config-mpls-router)# exit	Exit from the LDP configuration mode.
Qtech (config)# interface type ID	Enter the public network interface configuration mode.
Qtech (config-if-type ID)# label-switching	Enable the interface's MPLS forwarding function.
Qtech (config-if-type ID)# mpls ip	Enable the interface's LDP function and MPLS forwarding function.
Qtech (config-if-type ID)# ip ref	Enable the fast-forwarding function for routers.
Qtech (config-if-type ID)# end	Return to the privileged mode.
Qtech# copy running-config startup-config	Save configuration.

#Configure the public network tunnel between PEs.

```
Qtech# configure terminal
Qtech(config)# mpls ip
Qtech(config)# mpls router ldp
Qtech(config mpls router)# ldp router id interface loopback 0 force
Qtech(config mpls router)# exit
Qtech(config)# interface gigabitethernet 1/1
Qtech(config if GigabitEthernet 1/1)# label switching
Qtech(config if GigabitEthernet 1/1)# mpls ip
```

```
Qtech(config if GigabitEthernet 1/1)# end
Qtech# copy running config startup config
```



Note As the LDP protocol is topology-driven, the IPv4 route protocol must be enabled and work properly to allow IDP to work properly.

2.3.3.2 Configuring L2VPN VPLS address family

Kompella VPLS uses MP-BGP4 as signaling and auto-discovery mechanism. PE devices in one VPLS instance must exchange VPLS information through the L2VPN address family. By default, the L2VPN vpls address family is not supported. Procedures for enabling the L2VPN address family are as follows:

Command	Function
Qtech# configure terminal	Enter the global configuration mode.
Qtech (config)# router bgp <i>asn-num</i>	Create the BGP and enter the BGP configuration mode.
Qtech (config)# neighbor <i>peer-address</i> remote-as <i>asn-number</i>	Set up IBGP session.
Qtech (config)# neighbor <i>peer-address</i> update-source <i>interface-name</i>	Configure the IBGP session to use the address of the Loopback interface as the session's source address.
Ruiije (config-router)# address-family l2vpn vpls	Enter the L2VPN VPLS address family.
Qtech (config-router-af)# neighbor <i>ip-address</i> activate	Activate switching of VPLS information on the BGP session.
Qtech (config-router-af)# neighbor { <i>ip-address</i> <i>peer-group-name</i> } send-community [both standard extended]	Specify the extended community attribute to be sent to BGP neighbors.
Qtech (config-router-af)# end	Return from address family configuration mode to privileged mode.
Qtech# show bgp l2vpn vpls { all [id:offset neighbor ip-address summary] }	Display L2VPN VPLS address family information.

Configure the L2VPN address family and enable VPLS information switching

```
Qtech# configure terminal
Qtech(config)# router bgp 100
Qtech(config router)# neighbor 10.10.10.1 remote as 100
Qtech(config router)# neighbor 10.10.10.1 update source loopback 0
Ruiije(config router)# address family l2vpn vpls
Qtech(config router af)# neighbor 10.10.10.1 activate
Qtech(config router af)# neighbor 10.10.10.1 send community extended
Qtech(config router af)# end
Qtech# show bgp l2vpn vpls all
```

2.3.3.3 Configuring Kompella VPLS instance

The **l2 vfi** command can be used to create Kompella VPLS instances or enter the Kompella VPLS configuration mode. The **no l2 vfi** command can be used to delete VPLS instances. The sole local VPLS instance name and the sole local device VPN ID must be specified when the instance is being created. The auto-discovery must be enabled for the specified VPLS instance. The VPLS name should correspond to the VPN ID. In the auto-discovery mode, BGP is the default signal.

Command	Function
Qtech# config terminal	Enter the global configuration mode.
Qtech (config)# l2 vfi vpls-name vpnid vpn-id autodiscovery	Create the Kompella VPLS instance and enter the VPLS configuration mode.
Qtech (config-vfi)# signal bgp	Configuring the VPLS instance signal, which is BGP by default.
Qtech (config-vfi)# rd rd_value	First configure RD and configure RD value.
Qtech (config-vfi)# encapsulation mpls [ethernet ethernetvlan]	Specify the encapsulation mode of Kompella VPLS PWs, which is Ethernet (corresponding to the Raw mode) mode by default. If the sub-interface VPLS access mode is adopted, we recommend the ethernetvlan encapsulation mode (corresponding to the tag mode).
Qtech (config-vfi)# route-target { import export both } rt_value	Configure RTs. Multiple RTs can be configured.
Qtech (config-vfi)# site-id id [site-range size]	Configure VE IDs of VPLS sites and site range. If the site range is not configured, the default value of 16 will be adopted.
Qtech (config-vfi-site)# xconnect interface interface-id	Configure the interface bound by the site.
Qtech (config-vfi-site)# end	Exit from the site configuration mode.
Qtech# copy running-config startup-config	Save configuration.

Configure a Kompella VPLS instance.

```
Qtech#configure terminal
Qtech(config)# l2 vfi vpls 1 vpnid 1 autodiscovery
Qtech(config vfi)# signal bgp
Qtech(config vfi)# encapsulation mpls ethernet
Qtech(config vfi)# rd 100:1
Qtech(config vfi)# route target both 4500:2
Qtech(config vfi)# site id 1
Qtech(config vfi site)# xconnect interface gigabitethernet 1/1
Qtech(config vfi site)#end
Qtech# copy running config startup config
```



Note The autodiscovery key word must be specified after the **I2 vfi** command to create a Kompella VPLS instance.



Note The auto-discovery between PE devices in a VPLS instance is based on MP-BGP. To configure the Kompella VPLS, the VPLS PW signaling protocol must be specified as BGP.



Note To facilitate management, VPLS instances of one VPN should be configured with the same ID.



Note PEs on one VPLS must be configured with the same VPLS PW encapsulation mode. Otherwise, VPLS packets cannot be forwarded. Assuming that a vpls-x exists, if the vpls-x encapsulation mode on PE1 is Ethernet (corresponding to the Raw encapsulation mode), the vpls encapsulation mode on PE2 must not be ethernetvlan (corresponding to the tag encapsulation mode).

- For switches, dhcp packets cannot be transmitted transparently after ip dhcp snooping is enabled globally.
- It is not allowed to bind VPLS and VPWS with the default VLAN (VLAN1) when switches adopt L2 VPN service through Trunk ports.
- The SVI member ports of VPLS and VPWS bound with switches are Trunk ports or Hybrid ports. The member ports belong to all SVIs and cannot be enabled with IPv4/IPv6 multicast routing, IGMP Snooping or MLD Snooping.
- For switches, the VLAN port bound with the VPLS service cannot be configured with Subvlan, flexible QinQ, mac-vlan, private-vlan and supper-vlan.
- For switches, the Kompella VPLS can be bound to only one port.

2.3.3.4 Configuring user access VPLS

- For switches, the VPLS can only bind one interface. For routers, multiple interfaces can be bound.
- For switches, after an interface is bound to VPLS, the multicast function on the interface will be disabled automatically. After it is released, the function will be enabled on the interface.

Configuring VPLS access mode for switches

A created VPLS instance will only take effect after the user configured with the VPLS instance is connected with the link. Currently, there are the following three ways for switch users to access VPLS services:

- For switches, as VPLS is only supported by the SVI interface, a VPLS instance can only bind one SVI interface.



Note When the port protection mode is enabled on the AC-end member port of L2VPN, if the corresponding member port is not a Trunk interface, the port protection mode will not take effect on the member port.

❖ Vlan access port access

This mode applies when user packets transmitted on the VPLS access link are not encapsulated by 802.1q (the packets do not carry VLAN tag).

Command	Function
Qtech# config terminal	Enter the global configuration mode.
Qtech (config)# interface <i>type ID</i>	Enter the specified physical interface.
Qtech (config-if- <i>type ID</i>)# switchport mode access	Set the interface to work in the access mode.
Qtech (config-if- <i>type ID</i>)# switchport access <i>vlan-id</i>	Set the interface as a VLAN member port.
Qtech (config-if- <i>type ID</i>)# exit	Exit from the interface configuration mode.
Qtech (config)# interface vlan <i>vlan-id</i>	Enter the VLAN interface mode.
Qtech (config-if- <i>type ID</i>)# exit	Return to global configuration mode.
Qtech (config)# I2 vfi <i>vfi_name</i> vpnid <i>vpn_id</i> autodiscovery	Enter the vfi configuration mode.
Qtech (config-vfi)# site-id <i>id</i> [site-range <i>size</i>]	Configure VFI's site information.
Qtech (config-vfi-site)# xconnect interface <i>vlan id</i>	Configure the AC interface bound by the VPLS site.
Qtech (config-vfi-site)# end	Return to the privileged configuration mode.
Qtech# copy running-config startup-config	Save configuration.



Note For the access port access mode, we recommend setting the VPLS PW encapsulation mode as the **ethernet** mode (raw mode).

❖ VLAN trunk interface access

The access mode applies when multiple VPLS services are transmitted on a physical access link. Each VLAN corresponds with a VPLS instance. PE devices can match packets with VPLS instances according to VLAN tags carried by the user packets, and provide the access port multiplier mode.

Command	Function
Qtech# config terminal	Enter the global configuration mode.
Qtech (config)# interface <i>type ID</i>	Enter the specified physical interface.
Qtech (config-if- <i>type ID</i>)# switchport mode trunk	Set the interface to work in the trunk mode.
Qtech (config-if- <i>type ID</i>)# switchport trunk allow vlan add <i>vlan-list</i>	Set the VLAN flows allowed to be transmitted on the trunk link.
Qtech (config-if- <i>type ID</i>)# exit	Exit from the interface configuration mode.
Qtech (config)# interface vlan <i>vlan-id</i>	Enter the VLAN interface mode.
Qtech (config-if- <i>type ID</i>)# exit	Return to global configuration mode.

Qtech (config)# I2 vfi vfi_name vpnid vpn_id autodiscovery	Enter the vfi configuration mode.
Qtech (config-vfi)# site-id id [site-range size]	Configure VFI's site information.
Qtech (config-vfi-site)# xconnect interface vlan id	Configure the AC interface bound by the VPLS site.
Qtech (config-vfi-site)# end	Return to the privileged mode.
Qtech# copy running-config startup-config	Save configuration.



Caution For the Trunk interface access mode, we recommend setting the VPLS PW encapsulation mode as the **ethernetvlan** mode (tag mode).



Caution The L2 VPN service cannot be bound to the Native VLAN of the Trunk interface.

❖ Vlan tunnel port access

This mode applies when user service packets transmitted on the access link carry private Vlan tags when the user is connected to the VPLS service. In this mode, all packets received by PE from the interface will be forwarded without being processed. The mode requires the Vlan member port that connects PE with CE to work in the tunnel mode.

Command	Function
Qtech# config terminal	Enter the global configuration mode.
Qtech (config)# interface type ID	Enter the specified physical interface.
Qtech (config-if-type ID)# switchport access vlan-id	Set the interface as a VLAN member port.
Qtech (config-if-type ID)# switchport mode dot1q-tunnel	Set the interface to work in the tunnel mode.
Qtech (config-if-type ID)# exit	Exit from the interface configuration mode.
Qtech (config)# interface vlan vlan-id	Enter the VLAN interface mode.
Qtech (config-if-type ID)# exit	Return to global configuration mode.
Qtech (config)# I2 vfi vfi_name vpnid vpn_id autodiscovery	Enter the vfi configuration mode.
Qtech (config-vfi)# site-id id [site-range size]	Configure VFI's site information.
Qtech (config-vfi-site)# xconnect interface vlan id	Configure the AC interface bound by the VPLS site.
Qtech (config-vfi-site)# end	Return to the privileged mode.
Qtech# copy running-config startup-config	Save configuration.



Note For the VLAN tunnel port access mode, we recommend setting the VPLS PW encapsulation mode as the **ethernet** mode (raw mode).



Note For the VLAN tunnel port access mode, only the basic QinQ is supported, and flexible QinQ is not supported.

Configuring VPLS access mode for routers

A created VPLS instance will only take effect after the user configured with the VPLS instance is connected with the link.

There are the following two ways to access VPLS services:

❖ Ethernet interface access:

The Ethernet interface access mode applies when users access the VPLS services, the user service packets transmitted on the access link carry private Vlan tags or do not carry Vlan tags. In this mode, all packets received by PE from the interface will be forwarded according to the destination MAC and the private tags are considered part of the data. In such case, PE provides port-based VPLS services. The address learning mode of the VPLS instance of the bound port is the free mode. MAC address overlapping in the user VLAN is not supported.

Command	Function
Qtech# config terminal	Enter the global configuration mode.
Qtech (config)# interface <i>type ID</i>	Enter the specified physical interface.
Qtech (config-if-type ID)# ip ref	Enable the fast-forwarding function for routers.
Qtech (config-if-type ID)# end	Return to the privileged mode.
Qtech (config-if-type ID)# exit	Return to global configuration mode.
Qtech (config)# I2 vfi <i>vfi_name vpnid vpn_id autodiscovery</i>	Enter the vfi configuration mode.
Qtech (config-vfi)# site-id <i>id [site-range size]</i>	Configure VFI's site information.
Qtech (config-vfi-site)# xconnect interface <i>interface-id</i>	Configure the AC interface bound by the VPLS site.
Qtech (config-vfi-site)# end	Return to the privileged mode.
Qtech# copy running-config startup-config	Save configuration.

#Configure Ethernet interface VPLS access.

```
Qtech# configure terminal
Qtech(config)# interface gigabitethernet 1/2
```

#The interface's fast-forwarding function must be enabled for routers.

```
Qtech(config if GigabitEthernet 1/2)# ip ref
Qtech(config if GigabitEthernet 1/2)# exit
Qtech(config)# I2 vfi vfiA vpnid 1 autodiscovery
Qtech(config vfi)# rd 2:2
Qtech(config vfi)# route target both 2:2
Qtech(config vfi)# encapsulation mpls ethernet
Qtech(config vfi)# site id 1
Qtech(config vfi site)# xconnect interface gigabitethernet 1/2
Qtech(config vfi site)#end
Qtech# copy running config startup config
```



Caution

For the Ethernet access mode, we recommend using the **encapsulation mpls ethernet** command to specify the Kompella VPLS PW encapsulation mode as ethernet (raw mode). If the packets of imported PEs carry vlan tags, the tags will be transmitted transparently as private tags.

- For routers, a VPLS instance can be configured with mixed access modes. For example, PEs in a VPLS instance are configured with both Ethernet and sub-interface access modes. In such case, we recommend setting the VPLS PW encapsulation mode on the PEs as the ethernetvlan mode (tag mode).

❖ Sub-interface access:

PE devices can access a VPLS instance through a sub-interface.

Command	Function
Qtech# config terminal	Enter the global configuration mode.
Qtech(config)# interface type ID	Enter the specified physical interface.
Qtech (config-if-type ID)# ip ref	For routers, the fast-forwarding function must be enabled on the master interface of the sub-interface.
Qtech (config-if-type ID)# end	Return to the privileged mode.
Qtech (config-if-type ID)# exit	Return to global configuration mode.
Qtech (config)# I2 vfi vfi_name vpnid vpn_id autodiscovery	Enter the vfi configuration mode.
Qtech (config-vfi)# site-id id [site-range size]	Configure VFI's site information.
Qtech (config-vfi-site)# xconnect interface interface-id	Configure the AC interface bound by the VPLS site.
Qtech (config-vfi-site)# end	Return to the privileged mode.
Qtech# copy running-config startup-config	Save configuration.

Configure sub-interface VPLS access.

```
Qtech# configure terminal
```

The sub-interface's fast-forwarding function must be enabled for routers.

```
Qtech(config)# interface gigabitEthernet 1/2
Qtech(config-if-GigabitEthernet 1/2)# ip ref
Qtech(config-if-GigabitEthernet 1/2)# exit
Qtech(config)# interface gigabitEthernet 1/2.10
Qtech(config-if-GigabitEthernet 1/2.10)# encapsulation dot1Q 10
Qtech(config-if-GigabitEthernet 1/2.10)#exit
Qtech(config)# I2 vfi vfiA vpnid 1 autodiscovery
Qtech(config-vfi)# rd 2:2
Qtech(config-vfi)# route-target both 2:2
Qtech(config-vfi)# encapsulation mpls ethernetvlan
Qtech(config-vfi)# site-id 1
Qtech(config-vfi-site)# xconnect interface gigabitEthernet 1/2.10
Qtech(config-vfi-site)#end
```

```
Qtech# copy running-config startup-config
```



Note

For the sub-interface access mode, we recommend using the **encapsulation mpls ethernetvlan** command to specify the Kompella VPLS PW encapsulation mode as ethernetvlan (tag mode).

2.3.3.5 Configuring Kompella VPLS's Compatibility (Optional)

By default, the PW MTU value provided by L2VPN is 1,500 bytes. If the same PW's MTUs on two PEs are different, PW connection cannot be set up between the two PEs. Some producers' devices do not support configuring MTU in L2VPN instances. When such devices perform Kompella communication with devices of other producers, the **ingore match l2-extcommunity** command can be used to ignore received MTU and matching detection of Control Flag, thus ensuring the VC link is UP.

Command	Function
Qtech# config terminal	Enter the global configuration mode.
Qtech (config)# l2 vfi vpls-name vpnid vpn-id autodiscovery	Create the Kompella VPLS instance and enter the VPLS configuration mode.
Qtech (config-vfi)# ingore match l2-extcommunity	Configure ignoring detection of L2VPN expanded community attribute members.
Qtech# copy running-config startup-config	Save configuration.



Caution

This command only takes effect on Kompella L2VPN.

2.3.3.6 Verifying Kompella VPLS Configuration

Command	Function
show bgp l2vpn vpls all	Display NLRI information about all VPWS instances.
show bgp l2vpn vpls all connections	Display all connection information of Kompella VPLS.
show mpls l2transport vc [vc_id [ip-address]] [interface interface_name] [detail]	Display VC information established by Kompella VPLS.
show mpls vfi [name]	Display VPLS instance information.
Qtech# show mpls forwarding-table	Display PW-related ILM and FTN forwarding table entries.

2.3.4 Configuring Other VPLS Parameters

2.3.4.1 Configuring VPLS Instance Descriptors (Optional)

Users can configure the descriptive information of each VPLS instance.

Command	Function
---------	----------

Qtech# config terminal	Enter the global configuration mode.
Qtech (config)# l2 vfi vpls-name	Enter the VPLS configuration mode.
Qtech (config-vfi)# description vpls-description	(Optional) Configure VPLS's descriptive information.
Qtech (config-vfi)# end	Return to the privileged mode.
Qtech# copy running-config startup-config	Save configuration.

2.3.4.2 Configuring MTU of VPLS Instance (Optional)

You can configure each VPLS instance's MTU value, which is 1500 by default. The MTU value of VPLS indicates the length of packet that can be transmitted by PW, or the length of the user's layer-2 packet plus the length of PW-encapsulated packet. By default, if PW does not enable the control word, assuming that two labels are encapsulated, the length of an Ethernet packet that can be transmitted is 1,492 bytes, of which 8 bytes are encapsulated by PW (2 labels).

Command	Function
Qtech# config terminal	Enter the global configuration mode.
Qtech (config)# l2 vfi vpls-name	Enter the VPLS configuration mode.
Qtech (config-vfi)# mtu mtu	(Optional) Configure VPLS's MTU value.
Qtech (config-vfi)# end	Return to the privileged mode.
Qtech# copy running-config startup-config	Save configuration.



Caution

Mtus of one VPLS instance on different PEs must be configured the same. Otherwise, the signaling protocol cannot establish PW.



Caution

Currently, transmission of VPLS fragments is not supported. If the PW signaling protocol negotiation's MTU is modified, the MTU of the user access service interface must be adjusted (generally adjusted to the length of PW MTU minus the encapsulated length); the PW's public-network-end output interface's MTU, MPLS MTU and PW MTU must be the same to ensure proper forwarding. The **mtu** command can be used on an interface to modify the interface's MTU. Use the **mpls mtu** command to modify the interface's MPLS MTU.

2.3.4.3 Configuring VPLS Transparent Transmission Bridge Protocol Controlling Packet (Optional)

You can control whether the VPLS interface transparently transmits bridge protocol controlling packets to meet application needs.

Command	Function
Qtech# config terminal	Enter the global configuration mode.
Qtech (config)# interface type ID	Enter the specified interface mode.
Qtech (config-if-type ID)# l2 vfi tunnel-protocol stp	Configure the interface to transmit STP packets transparently.
Qtech (config-if-type ID)# end	Return to the privileged mode.

Qtech# copy running-config startup-config	Save configuration.
--	---------------------



Caution Generally, BPDU packets do not carry VLAN Tag. If CEs access to PEs through a Trunk interface or sub-interface and the BPDU transparent transmission function is enabled on the access port, the BPDU packets sent by CEs must carry corresponding VLAN Tag to be identified by the corresponding VPLS instances and transmitted transparently in the VPLS instances.

2.3.4.4 Configuring MAC Address Aging Time (Optional)

You can configure each VPLS instance's address aging time, which is 300 seconds by default.

Command	Function
Qtech# config terminal	Enter the global configuration mode.
Qtech (config)# l2 vfi vpls-name	Enter the VPLS configuration mode.
Qtech (config-vfi)# mac-address aging-time interval	(Optional) Configure VPLS's address aging time.
Qtech (config-vfi)# end	Return to the privileged mode.
Qtech# copy running-config startup-config	Save configuration.



Caution If the aging time of MAC addresses is changed, all the MAC address will be aged according to the new aging time. If the aging time is set to m, MACs that have not performed communication will be aged after m.

- For QSW-6510 series products enabled with VPLS forwarding, the aging time of MAC addresses is configured by executing the **mac-address-table aging-time** command in global configuration. It cannot be configured separately for each VPLS instance.

2.3.4.5 Configuring MAC Address Capacity Volume Limit (Optional)

- Switches do not support the **mac-limit** command.

You can configure each VPLS instance's MAC address capacity limit and behavior to be performed when the limit is exceeded.

Command	Function
Qtech# config terminal	Enter the global configuration mode.
Qtech (config)# l2 vfi vpls-name	Enter the VPLS configuration mode.
Qtech(config-vfi)# mac-limit { action { discard forward } maximum count	(Optional) Configure each VPLS instance's MAC address capacity limit and behavior to be performed when the limit is exceeded.
Qtech (config-vfi)# end	Return to the privileged mode.
Qtech# copy running-config startup-config	Save configuration.

**Caution**

By default, the message warning of exceeding the capacity is disabled. If it is enabled, when the MAC capacity of the VPLS instance is exceeded for the first time, the Log message will be displayed; when the VPLS MAC capacity drops to below the limit, the Log message will be displayed again.

Configuring Static MAC Addresses (Optional)

You can configure static MAC addresses for VPLS instances. When conflicts exist in static MAC addresses and dynamically learnt ones, you can disable the dynamic learning of MAC addresses.

Command	Function
Qtech# config terminal	Enter the global configuration mode.
Qtech (config)# mpls static vfname mac-address H.H.H{ neighbor ip-address interface interface-name vlan-port interface-name vlan-if vlanvlan-num}	Configure MAC addresses for a VPLS instance.
Qtech (config)# end	Return to the privilege mode.
Qtech# copy running-config startup-config	Save the configuration.

**Caution**

Static MAC address configuration realized through configuration of relate PWs of neighbor addresses can only work properly in the following scenario: The L2VPN instance has only a PW for the neighbor configured. If the L2VPN instance is configured with multiple PWs for the neighbor, the configured static MAC address will bind with a PW randomly, leading to wrong forwarding.

Configuring Dynamic MAC Addresses (Optional)

A VPLS instance can dynamically learn MAC addresses from ACs and PWs. You can clear the MAC addresses dynamically learnt by VPLS instances, including the local and remote VPLS instances.

Command	Function
Qtech# config terminal	Enter the global configuration mode.
Qtech# clear l2 vfi vpls-name mac-address local	Delete the MAC addresses dynamically learnt by the local (local PE) VPLS instance.
Qtech# clear l2 vfi vpls-name mac-address remote	Delete the MAC addresses dynamically learnt by the remote (another PE) VPLS instance.

**Caution**

Deletion of MAC of a remote PE is only effective for Martini VPLS.

2.4 Configuration Examples

2.4.1 Typical Examples of Martini VPLS Configuration for Switches

2.4.1.1 Basic VPLS

As shown in the following figure, CE1 and CE2 access the same VPLS network through PE1 and PE2. PE1, P, and PE2 form a public MPLS network that provides VPLS services. On PE1 and PE2, bind VLAN 10 to the VPLS instance.

Figure 1-35

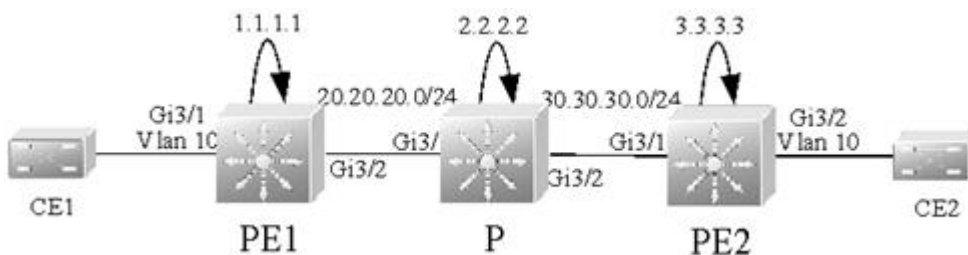

The configuration procedure is as follows:

PE1:

Configure the loopback interface.

```
Qtech(config)# interface loopback 0
Qtech(config if Loopback 0)# ip address 1.1.1.1 255.255.255.255
Qtech(config if Loopback 0)# exit
```

Enable OSPF and configure public routes.

```
Qtech(config)# router ospf 10
Qtech(config router)# network 1.1.1.1 0.0.0.0 area 0
Qtech(config router)# network 20.20.20.0 0.0.0.255 area 0
Qtech(config router)# exit
```

Configure the LDP and enable MPLS globally.

```
Qtech(config)# mpls ip
Qtech(config)# mpls router ldp
Qtech(config mpls router)# ldp router id interface loopback 0 force
Qtech(config mpls router)# neighbor 3.3.3.3
Qtech(config mpls router)# exit
```

Enable LDP and MPLS on the public interface.

```
Qtech(config)# interface gigabitEthernet 3/2
Qtech(config if GigabitEthernet 3/2)# no switchport
Qtech(config if GigabitEthernet 3/2)# ip address 20.20.20.1 255.255.255.0
```

```
Qtech(config if GigabitEthernet 3/2)# mpls ip
Qtech(config if GigabitEthernet 3/2)# label switching
Qtech(config if GigabitEthernet 3/2)# exit
```

Configure a VPLS instance and specify the peer PE.

```
Qtech(config)# 12 vfi vfi_a vpnid 1
Qtech(config vpls)# neighbor 3.3.3.3 encapsulation mpls
Qtech(config vpls)# exit
```

Bind the VLAN interface to the VPLS instance.

```
Qtech(config)# vlan 10
Qtech(config vlan)# exit
Qtech(config)# interface vlan 10
Qtech(config if Vlan 10)# xconnect vfi vfi_a
Qtech(config if Vlan 10)# exit
```

Configure the PE interface connected to CEs.

```
Qtech(config)# interface gigabitEthernet 3/1
Qtech(config if GigabitEthernet 3/1)# switchport access vlan 10
Qtech(config if GigabitEthernet 3/1)# exit
```

PE1:

Configure the loopback interface.

```
Qtech(config)# interface loopback 0
Qtech(config if Loopback 0)# ip address 2.2.2.2 255.255.255.255
Qtech(config if Loopback 0)# exit
```

Enable OSPF and configure public routes.

```
Qtech(config)# router ospf 10
Qtech(config router)# network 2.2.2.2 0.0.0.0 area 0
Qtech(config router)# network 20.20.20.0 0.0.0.255 area 0
Qtech(config router)# network 30.30.30.0 0.0.0.255 area 0
Qtech(config router)# exit
```

Configure the LDP and enable MPLS globally.

```
Qtech(config)# mpls ip
Qtech(config)# mpls router ldp
Qtech(config mpls router)# ldp router id interface loopback 0 force
Qtech(config mpls router)# exit
```

Enable LDP and MPLS on an interface.

```
Qtech(config)# interface gigabitEthernet 3/1
Qtech(config if GigabitEthernet 3/1)# no switchport
Qtech(config if GigabitEthernet 3/1)# ip address 20.20.20.2 255.255.255.0
Qtech(config if GigabitEthernet 3/1)# mpls ip
```

```
Qtech(config if GigabitEthernet 3/1)# label switching
Qtech(config if GigabitEthernet 3/1)# exit
Qtech(config)# interface gigabitEthernet 3/2
Qtech(config if GigabitEthernet 3/2)# no switchport
Qtech(config if GigabitEthernet 3/2)# ip address 30.30.30.1 255.255.255.0
Qtech(config if GigabitEthernet 3/2)# mpls ip
Qtech(config if GigabitEthernet 3/2)# label switching
Qtech(config if GigabitEthernet 3/2)# exit
```

PE2:

Configure the loopback interface.

```
Qtech(config)# interface loopback 0
Qtech(config if Loopback 0)# ip address 3.3.3.3 255.255.255.255
Qtech(config if Loopback 0)# exit
```

Enable OSPF and configure public routes.

```
Qtech(config)# router ospf 10
Qtech(config router)# network 3.3.3.3 0.0.0.0 area 0
Qtech(config router)# network 30.30.30.0 0.0.0.255 area 0
Qtech(config router)# exit
```

Configure the LDP and enable MPLS globally.

```
Qtech(config)# mpls ip
Qtech(config)# mpls router ldp
Qtech(config mpls router)# ldp router id interface loopback 0 force
Qtech(config mpls router)# neighbor 1.1.1.1
Qtech(config mpls router)# exit
```

Enable LDP and MPLS on the public interface.

```
Qtech(config)# interface gigabitEthernet 3/1
Qtech(config if GigabitEthernet 3/1)# no switchport
Qtech(config if GigabitEthernet 3/1)# ip address 30.30.30.2 255.255.255.0
Qtech(config if GigabitEthernet 3/1)# mpls ip
Qtech(config if GigabitEthernet 3/1)# label switching
Qtech(config if GigabitEthernet 3/1)# exit
```

Configure a VPLS instance and specify the peer PE.

```
Qtech(config)# 12 vfi vfi_a vpnid 1
Qtech(config vpls)# neighbor 1.1.1.1 encapsulation mpls
Qtech(config vpls)# exit
```

Bind the VLAN interface to the VPLS instance.

```
Qtech(config)# vlan 10
Qtech(config vlan)# exit
Qtech(config)# interface vlan 10
```



```
Qtech(config if Vlan 10)# xconnect vfi vfi_a
Qtech(config if Vlan 10)# exit
```

Configure the PE interface connected to CEs.

```
Qtech(config)# interface gigabitEthernet 3/2
Qtech(config if GigabitEthernet 3/2)# switchport access vlan 10
Qtech(config if GigabitEthernet 3/2)# exit
```

2.4.1.2 H-VPLS (PW Access)

Figure 1-36

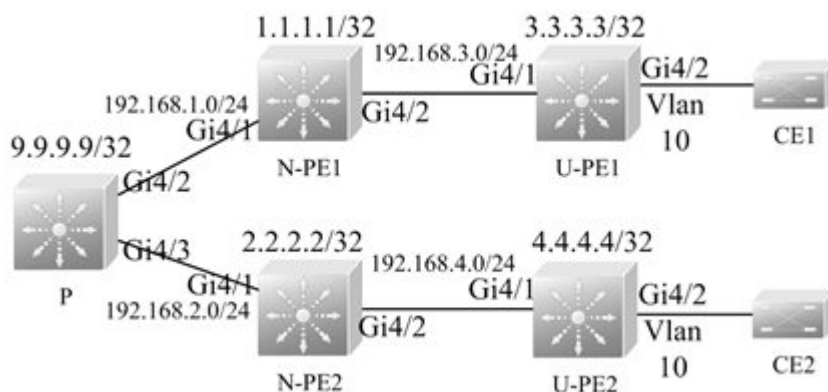

As shown in the preceding figure, CE1 and CE2 access the same H-VPLS network through U-PE1 and U-PE2, which are connected to N-PE1 and N-PE2 respectively. The N-PEs and U-PEs are connected through PWs. All U-PEs and N-PEs belong to the MPLS network and work together to provide VPLS services.

When you set up PWs between N-PEs and U-PEs, you must specify the PW of the N-PE with the U-PE as a Spoke PW. On the U-PE end, however, the PW type is not restricted. If the U-PE supports VPLS, the PW with the N-PE can be either a Hub PW or a Spoke PW. If the U-PE does not support VPLS, the VPWS PW can also be configured.

In this example, U-PE1 and N-PE1 are connected through a Hub PW whereas U-PE2 and N-PE2 are connected through a VPWS PW.

❖ U-PE1:

Configure the loopback interface.

```
Qtech(config)# interface loopback 0
Qtech(config if Loopback 0)# ip address 3.3.3.3 255.255.255.255
Qtech(config if Loopback 0)# exit
```

Enable OSPF and configure public routes.

```
Qtech(config)# router ospf 10
Qtech(config router)# network 3.3.3.3 0.0.0.0 area 0
Qtech(config router)# network 192.168.3.0 0.0.0.255 area 0
```

```
Qtech(config router)# exit
```

Configure the LDP and enable MPLS globally.

```
Qtech(config)# mpls ip
Qtech(config)# mpls router ldp
Qtech(config mpls router)# ldp router id interface loopback 0 force
Qtech(config mpls router)# neighbor 1.1.1.1
Qtech(config mpls router)# exit
```

Enable LDP and MPLS on the public interface.

```
Qtech(config)# interface gigabitEthernet 4/1
Qtech(config if GigabitEthernet 4/1)# no switchport
Qtech(config if GigabitEthernet 4/1)# ip address 192.168.3.2 255.255.255.0
Qtech(config if GigabitEthernet 4/1)# mpls ip
Qtech(config if GigabitEthernet 4/1)# label switching
Qtech(config if GigabitEthernet 4/1)# exit
```

Configure a VPLS instance and configure a PW to connect the peer N-PE.

```
Qtech(config)# 12 vfi vfi_a vpnid 1
Qtech(config vpls)# neighbor 1.1.1.1 encapsulation mpls
Qtech(config vpls)# exit
```

Bind the VLAN interface to the VPLS instance.

```
Qtech(config)# vlan 10
Qtech(config vlan)# exit
Qtech(config)# interface vlan 10
Qtech(config if Vlan 10)# xconnect vfi vfi_a
Qtech(config if Vlan 10)# exit
```

Configure the PE interface connected to CEs.

```
Qtech(config)# interface gigabitEthernet 4/2
Qtech(config if GigabitEthernet 4/2)# switchport access vlan 10
Qtech(config if GigabitEthernet 4/2)# exit
```

❖ N-PE1:

Configure the loopback interface.

```
Qtech(config)# interface loopback 0
Qtech(config if Loopback 0)# ip address 1.1.1.1 255.255.255.255
Qtech(config if Loopback 0)# exit
```

Enable OSPF and configure public routes.

```
Qtech(config)# router ospf 10
Qtech(config router)# network 1.1.1.1 0.0.0.0 area 0
Qtech(config router)# network 192.168.1.0 0.0.0.255 area 0
Qtech(config router)# network 192.168.3.0 0.0.0.255 area 0
```

```
Qtech(config router)# exit
```

Configure the LDP and enable MPLS globally.

```
Qtech(config)# mpls ip
Qtech(config)# mpls router ldp
Qtech(config mpls router)# ldp router id interface loopback 0 force
Qtech(config mpls router)# neighbor 2.2.2.2
Qtech(config mpls router)# neighbor 3.3.3.3
Qtech(config mpls router)# exit
```

Enable LDP and MPLS on the public interface.

```
Qtech(config)# interface gigabitEthernet 4/1
Qtech(config if GigabitEthernet 4/1)# no switchport
Qtech(config if GigabitEthernet 4/1)# ip address 192.168.1.2 255.255.255.0
Qtech(config if GigabitEthernet 4/1)# mpls ip
Qtech(config if GigabitEthernet 4/1)# label switching
Qtech(config if GigabitEthernet 4/1)# exit
Qtech(config)# interface gigabitEthernet 4/2
Qtech(config if GigabitEthernet 4/2)# no switchport
Qtech(config if GigabitEthernet 4/2)# ip address 192.168.3.1 255.255.255.0
Qtech(config if GigabitEthernet 4/2)# mpls ip
Qtech(config if GigabitEthernet 4/2)# label switching
Qtech(config if GigabitEthernet 4/2)# exit
```

Configure a VPLS instance, a Hub PW to connect another N-PE, and the Spoke PW to connect the peer U-PE.

```
Qtech(config)# 12 vfi vfi_a vpnid 1
Qtech(config vpls)# neighbor 2.2.2.2 encapsulation mpls
Qtech(config vpls)# neighbor 3.3.3.3 encapsulation mpls spoke vc
Qtech(config vpls)# exit
```

❖ N-PE1:

Configure the loopback interface.

```
Qtech(config)# interface loopback 0
Qtech(config if Loopback 0)# ip address 9.9.9.9 255.255.255.255
Qtech(config if Loopback 0)# exit
```

Enable OSPF and configure public routes.

```
Qtech(config)# router ospf 10
Qtech(config router)# network 9.9.9.9 0.0.0.0 area 0
Qtech(config router)# network 192.168.1.0 0.0.0.255 area 0
Qtech(config router)# network 192.168.2.0 0.0.0.255 area 0
Qtech(config router)# exit
```

Configure the LDP and enable MPLS globally.

```
Qttech(config)# mpls ip
Qttech(config)# mpls router ldp
Qttech(config mpls router)# ldp router id interface loopback 0 force
Qttech(config mpls router)# exit
```

Enable LDP and MPLS on an interface.

```
Qttech(config)# interface gigabitEthernet 4/2
Qttech(config if GigabitEthernet 4/2)# no switchport
Qttech(config if GigabitEthernet 4/2)# ip address 192.168.1.1 255.255.255.0
Qttech(config if GigabitEthernet 4/2)# mpls ip
Qttech(config if GigabitEthernet 4/2)# label switching
Qttech(config if GigabitEthernet 4/2)# exit
Qttech(config)# interface gigabitEthernet 4/3
Qttech(config if GigabitEthernet 4/3)# no switchport
Qttech(config if GigabitEthernet 4/3)# ip address 192.168.2.1 255.255.255.0
Qttech(config if GigabitEthernet 4/3)# mpls ip
Qttech(config if GigabitEthernet 4/3)# label switching
Qttech(config if GigabitEthernet 4/3)# exit
```

❖ N-PE2:

Configure the loopback interface.

```
Qttech(config)# interface loopback 0
Qttech(config if Loopback 0)# ip address 2.2.2.2 255.255.255.255
Qttech(config if Loopback 0)# exit
```

Enable OSPF and configure public routes.

```
Qttech(config)# router ospf 10
Qttech(config router)# network 2.2.2.2 0.0.0.0 area 0
Qttech(config router)# network 192.168.2.0 0.0.0.255 area 0
Qttech(config router)# network 192.168.4.0 0.0.0.255 area 0
Qttech(config router)# exit
```

Configure the LDP and enable MPLS globally.

```
Qttech(config)# mpls ip
Qttech(config)# mpls router ldp
Qttech(config mpls router)# ldp router id interface loopback 0 force
Qttech(config mpls router)# neighbor 1.1.1.1
Qttech(config mpls router)# neighbor 4.4.4.4
Qttech(config mpls router)# exit
```

Enable LDP and MPLS on the public interface.

```
Qttech(config)# interface gigabitEthernet 4/1
Qttech(config if GigabitEthernet 4/1)# no switchport
Qttech(config if GigabitEthernet 4/1)# ip address 192.168.2.2 255.255.255.0
```

```
Qtech(config if GigabitEthernet 4/1)# mpls ip
Qtech(config if GigabitEthernet 4/1)# label switching
Qtech(config if GigabitEthernet 4/1)# exit
Qtech(config)# interface gigabitEthernet 4/2
Qtech(config if GigabitEthernet 4/2)# no switchport
Qtech(config if GigabitEthernet 4/2)# ip address 192.168.4.1 255.255.255.0
Qtech(config if GigabitEthernet 4/2)# mpls ip
Qtech(config if GigabitEthernet 4/2)# label switching
Qtech(config if GigabitEthernet 4/2)# exit
```

Configure a VPLS instance, a Hub PW to connect another N-PE, and the Spoke PW to connect the peer U-PE.

```
Qtech(config)# l2 vfi vfi_a vpnid 1
Qtech(config vpls)# neighbor 1.1.1.1 encapsulation mpls
Qtech(config vpls)# neighbor 4.4.4.4 encapsulation mpls spoke vc
Qtech(config vpls)# exit
```

❖ U-PE2:

Configure the loopback interface.

```
Qtech(config)# interface loopback 0
Qtech(config if Loopback 0)# ip address 4.4.4.4 255.255.255.255
Qtech(config if Loopback 0)# exit
```

Enable OSPF and configure public routes.

```
Qtech(config)# router ospf 10
Qtech(config router)# network 4.4.4.4 0.0.0.0 area 0
Qtech(config router)# network 192.168.4.0 0.0.0.255 area 0
Qtech(config router)# exit
```

Configure the LDP and enable MPLS globally.

```
Qtech(config)# mpls ip
Qtech(config)# mpls router ldp
Qtech(config mpls router)# ldp router id interface loopback 0 force
Qtech(config mpls router)# neighbor 2.2.2.2
Qtech(config mpls router)# exit
```

Enable LDP and MPLS on the public interface.

```
Qtech(config)# interface gigabitEthernet 4/1
Qtech(config if GigabitEthernet 4/1)# no switchport
Qtech(config if GigabitEthernet 4/1)# ip address 192.168.4.2 255.255.255.0
Qtech(config if GigabitEthernet 4/1)#mpls ip
Qtech(config if GigabitEthernet 4/1)# label switching
Qtech(config if GigabitEthernet 4/1)# exit
```

Configure a VPWS PW for a VLAN interface.

```

Qttech(config)# vlan 10
Qttech(config vlan)# exit
Qttech(config)# interface vlan 10
Qttech(config if Vlan 10)# xconnect 2.2.2.2 1 encapsulation mpls ethernet
Qttech(config if Vlan 10)# exit

```

Configure the PE interface connected to CEs.

```

Qttech(config)# interface gigabitEthernet 4/2
Qttech(config if GigabitEthernet 4/2)# switchport access vlan 10
Qttech(config if GigabitEthernet 4/2)# exit

```

H-VPLS (QinQ Access and Dual-Homed)

If the U-PE and N-PE are connected through only one Spoke, the U-PE communication with the external network is discontinued if the Spoke connection fails. To solve this problem, you can connect the U-PE to N-PEs in dual-homed mode. In this mode, the U-PE are connected to different N-PEs, which belong to the same VPLS network, through two (or more) Spoke connections. In normal situations, only one of the Spoke connections is in the working status. It is called the active connection and the others are backup ones. If the active connection fails, one backup connection is chosen to take over the task.

The following shows a schematic diagram of an H-VPLS network in dual-homed mode.

Figure 1-37

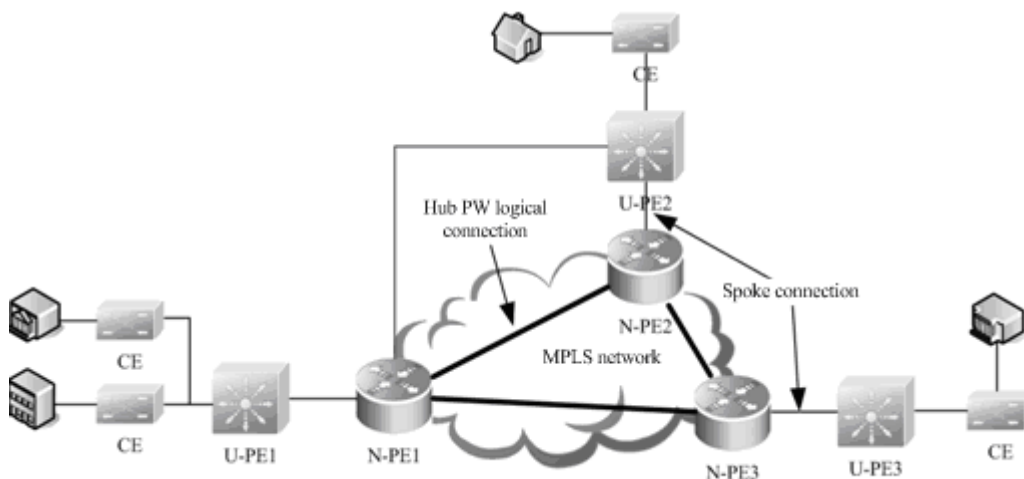

In an H-VPLS network in QinQ and dual-homed access mode, you can use the STP to switch over the active and standby connections. The STP, however, does not belong to users and is transmitted only over the carrier's network (U-PEs and N-PEs). To avoid the impact of STP protocol packets (BPDUs) on user packets, you should create a special VPLS instance on the N-PE to transparently transmit BPDUs in dual-homed mode.

Figure 1-38

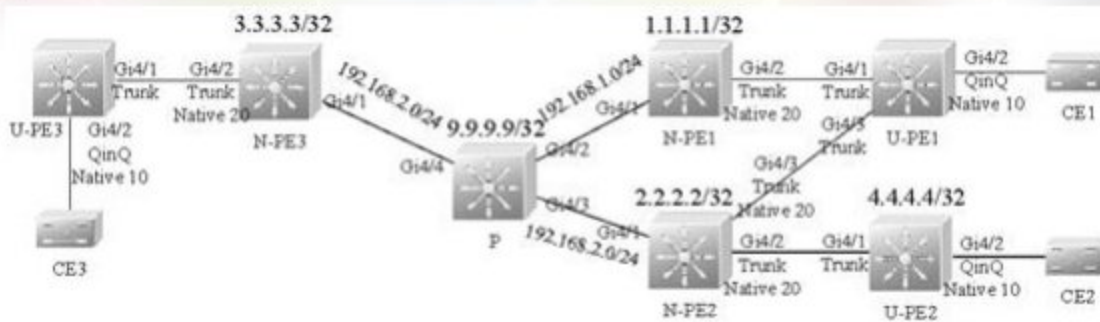

The preceding figure shows an H-VPLS topology in dual-homed mode. The CE is connected to U-PEs in the same H-VPLS network and the U-PEs are connected to N-PEs through the QinQ tunnel. The N-PEs belong to the MPLS network and the U-PEs do not run MPLS, but the N-PEs and U-PEs work together to provide VPLS services. The upstream interface on the U-PE works in trunk mode and allows the traffic of the VLAN to which the U-PE interface connected to the CE belongs to pass through. Enable QinQ on the interfaces that connect U-PEs and CEs. This QinQ native VLAN cannot be the same as the native VLAN on the U-PE1 interface connected to the N-PE or the native VLAN on the N-PE interface connected to the U-PE. This is because the QinQ native VLAN on the interfaces that connect U-PEs and CEs is used to identify VPLS instances provided for a user whereas the native VLAN on the N-PE trunk interface connected to the U-PE is used to identify the VPLS instance for transparently transmitting BPDUs in dual-homed mode. Set up Hub PWs between N-PEs. Enable dual-homed mode on U-PE1 and you can find that U-PE1 is connected to both N-PE1 and N-PE2.

As shown in Figure 1-27, only one VPLS instance is provided for the user. You are required to create a special VPLS instance to transparently transmit BPDUs in dual-homed mode. This VPLS instance is enabled on the N-PEs to which the U-PE is connected.

U-PE1:

Configure a Spoke connection to the peer N-PE1.

```
Qtech(config)# interface gigabitEthernet 4/1
Qtech(config-if-GigabitEthernet 4/1)# switchport mode trunk
Qtech(config-if-GigabitEthernet 4/1)# exit
```

Configure a Spoke connection to the peer N-PE2.

```
Qtech(config)# interface gigabitEthernet 4/3
Qtech(config-if-GigabitEthernet 4/3)# switchport mode trunk
Qtech(config-if-GigabitEthernet 4/3)# exit
```

Configure the PE interface connected to CEs.

```
Qtech(config)# interface gigabitEthernet 4/2
Qtech(config-if-GigabitEthernet 4/2)# switchport access vlan 10
Qtech(config-if-GigabitEthernet 4/2)# switchport mode dot1q-tunnel
Qtech(config-if-GigabitEthernet 4/2)# exit
```

Enable STP only on the U-PEs that adopt the dual-homed access mode.

```
Qttech(config)# spanning tree
```

N-PE1:

Configure the loopback interface.

```
Qttech(config)# interface loopback 0
Qttech(config if Loopback 0)# ip address 1.1.1.1 255.255.255.255
Qttech(config if Loopback 0)# exit
```

Enable OSPF and configure public routes.

```
Qttech(config)# router ospf 10
Qttech(config router)# network 1.1.1.1 0.0.0.0 area 0
Qttech(config router)# network 192.168.1.0 0.0.0.255 area 0
Qttech(config router)# exit
```

Configure the LDP and enable MPLS globally.

```
Qttech(config)# mpls ip
Qttech(config)# mpls router ldp
Qttech(config mpls router)# ldp router id interface loopback 0 force
Qttech(config mpls router)# neighbor 2.2.2.2
Qttech(config mpls router)# neighbor 3.3.3.3
Qttech(config mpls router)# exit
```

Enable LDP and MPLS on the public interface.

```
Qttech(config)# interface gigabitEthernet 4/1
Qttech(config if GigabitEthernet 4/1)# no switchport
Qttech(config if GigabitEthernet 4/1)# ip address 192.168.1.2 255.255.255.0
Qttech(config if GigabitEthernet 4/1)# mpls ip
Qttech(config if GigabitEthernet 4/1)# label switching
Qttech(config if GigabitEthernet 4/1)# exit
```

Configure the N-PE interface connected to the U-PE.

```
Qttech(config)# interface gigabitEthernet 4/2
Qttech(config if GigabitEthernet 4/2)# switchport mode trunk
Qttech(config if GigabitEthernet 4/2)# switchport trunk native vlan 20
Qttech(config if GigabitEthernet 4/2)# exit
```

Configure a VPLS instance for the user and configure Hub PWs to connect the N-PEs in the same VPLS instance.

```
Qttech(config)# 12 vfi vfi_a vpnid 1
Qttech(config vpls)# neighbor 2.2.2.2 encapsulation mpls
Qttech(config vpls)# neighbor 3.3.3.3 encapsulation mpls
Qttech(config vpls)# exit
```

Bind the QinQ VLAN interface to the VPLS instance.

```
Qtech(config)# vlan 10
Qtech(config vlan)# exit
Qtech(config)# interface vlan 10
Qtech(config if Vlan 10)# xconnect vfi vfi_a
Qtech(config if Vlan 10)# exit
```

Configure the VPLS instance to transparently transmit BPDUs and configure Hub PWs to connect other N-PEs in dual-homed mode.

```
Qtech(config)# 12 vfi vfi_bpdu vpnid 100
Qtech(config vpls)# neighbor 2.2.2.2 encapsulation mpls
Qtech(config vpls)# exit
```

Bind the native VLAN interface, which is used to transparently transmit BPDUs, to the VPLS instance.

```
Qtech(config)# vlan 20
Qtech(config vlan)# exit
Qtech(config)# interface vlan 20
Qtech(config if Vlan 20)# xconnect vfi vfi_bpdu
Qtech(config if Vlan 20)# 12 vfi tunnel protocol stp
Qtech(config if Vlan 20)# exit
```

P:

Configure the loopback interface.

```
Qtech(config)# interface loopback 0
Qtech(config if Loopback 0)# ip address 9.9.9.9 255.255.255.255
Qtech(config if Loopback 0)# exit
```

Enable OSPF and configure public routes.

```
Qtech(config)# router ospf 10
Qtech(config router)# network 9.9.9.9 0.0.0.0 area 0
Qtech(config router)# network 192.168.1.0 0.0.0.255 area 0
Qtech(config router)# network 192.168.2.0 0.0.0.255 area 0
Qtech(config router)# exit
```

Configure the LDP and enable MPLS globally.

```
Qtech(config)# mpls ip
Qtech(config)# mpls router ldp
Qtech(config mpls router)# ldp router id interface loopback 0 force
Qtech(config mpls router)# exit
```

Enable LDP and MPLS on an interface.

```
Qtech(config)# interface gigabitEthernet 4/2
Qtech(config if GigabitEthernet 4/2)# no switchport
```

```
Qtech(config if GigabitEthernet 4/2)# ip address 192.168.1.1 255.255.255.0
Qtech(config if GigabitEthernet 4/2)# mpls ip
Qtech(config if GigabitEthernet 4/2)# label switching
Qtech(config if GigabitEthernet 4/2)# exit
Qtech(config)# interface gigabitEthernet 4/3
Qtech(config if GigabitEthernet 4/3)# no switchport
Qtech(config if GigabitEthernet 4/3)# ip address 192.168.2.1 255.255.255.0
Qtech(config if GigabitEthernet 4/3)# mpls ip
Qtech(config if GigabitEthernet 4/3)# label switching
Qtech(config if GigabitEthernet 4/3)# exit
```

N-PE2:

Configure the loopback interface.

```
Qtech(config)# interface loopback 0
Qtech(config if Loopback 0)# # ip address 2.2.2.2 255.255.255.255
Qtech(config if Loopback 0)# exit
```

Enable OSPF and configure public routes.

```
Qtech(config)# router ospf 10
Qtech(config router)# network 2.2.2.2 0.0.0.0 area 0
Qtech(config router)# network 192.168.2.0 0.0.0.255 area 0
Qtech(config router)# exit
```

Configure the LDP and enable MPLS globally.

```
Qtech(config)# mpls ip
Qtech(config)# mpls router ldp
Qtech(config mpls router)# ldp router id interface loopback 0 force
Qtech(config mpls router)# neighbor 1.1.1.1
Qtech(config mpls router)# neighbor 3.3.3.3
Qtech(config mpls router)# exit
```

Enable LDP and MPLS on the public interface.

```
Qtech(config)# interface gigabitEthernet 4/1
Qtech(config if GigabitEthernet 4/1)# no switchport
Qtech(config if GigabitEthernet 4/1)# ip address 192.168.2.2 255.255.255.0
Qtech(config if GigabitEthernet 4/1)# mpls ip
Qtech(config if GigabitEthernet 4/1)# label switching
Qtech(config if GigabitEthernet 4/1)# exit
```

Configure the N-PE interface connected to U-PEs (to two U-PEs at the same time).

```
Qtech(config)# interface gigabitEthernet 4/2
Qtech(config if GigabitEthernet 4/2)# switchport mode trunk
Qtech(config if GigabitEthernet 4/2)# switchport trunk native vlan 20
Qtech(config if GigabitEthernet 4/2)# exit
```

```
Qtech(config)# interface gigabitEthernet 4/3
Qtech(config if GigabitEthernet 4/3)# switchport mode trunk
Qtech(config if GigabitEthernet 4/3)# switchport trunk native vlan 20
Qtech(config if GigabitEthernet 4/3)# exit
```

Configure a VPLS instance for the user and configure Hub PWs to connect the N-PEs in the same VPLS instance.

```
Qtech(config)# 12 vfi vfi_a vpnid 1
Qtech(config vpls)# neighbor 1.1.1.1 encapsulation mpls
Qtech(config vpls)# neighbor 3.3.3.3 encapsulation mpls
Qtech(config vpls)# exit
```

Bind the QinQ VLAN interface to the VPLS instance.

```
Qtech(config)# vlan 10
Qtech(config vlan)# exit
Qtech(config)# interface vlan 10
Qtech(config if Vlan 10)# xconnect vfi vfi_a
Qtech(config if Vlan 10)# exit
```

Configure the VPLS instance to transparently transmit BPDUs and configure Hub PWs to connect other N-PEs in dual-homed mode.

```
Qtech(config)# 12 vfi vfi_bpdu vpnid 100
Qtech(config vpls)# neighbor 1.1.1.1 encapsulation mpls
Qtech(config vpls)# exit
```

Bind the native VLAN interface, which is used to transparently transmit BPDUs, to the VPLS instance.

```
Qtech(config)# vlan 20
Qtech(config vlan)# exit
Qtech(config)# interface vlan 20
Qtech(config if Vlan 20)# xconnect vfi vfi_bpdu
Qtech(config if Vlan 20)# 12 vfi tunnel protocol stp
Qtech(config if Vlan 20)# exit
```

U-PE2:

Refer to U-PE1. Since U-PE2 is connected to only one N-PE, STP is not required.

U-PE3:

Refer to U-PE2.

N-PE3:

Refer to N-PE1.

2.4.2 Typical Examples of Martini VPLS Configuration for Routers

2.4.2.1 Basic VPLS (Ethernet interface access)

As shown in the following figure, CE1 and CE2 access the same VPLS network through PE1 and PE2. PE1, P, and PE2 form a public MPLS network to provide VPLS services. Gi0/1 is bound on PE1 and PE2 to the VPLS instance.

Figure 1-39

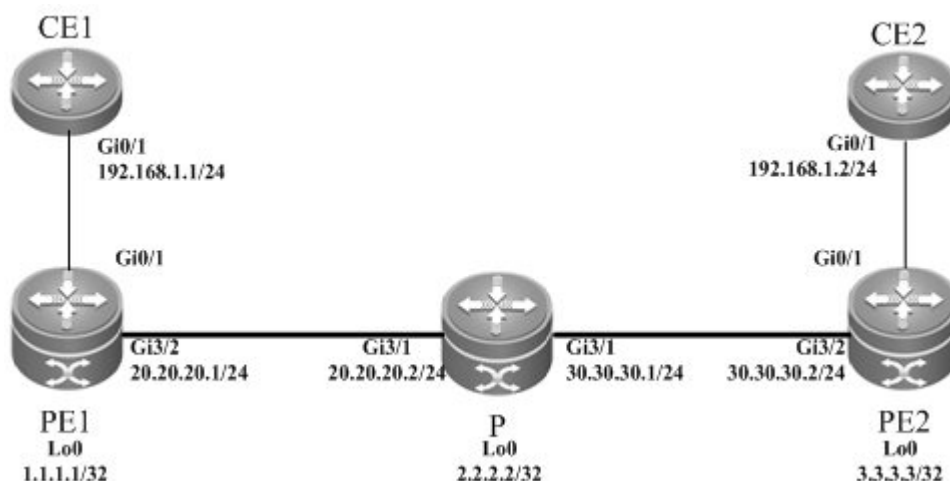

The configuration process is described as follows:

PE1:

Configure Loopback interface address.

```
Qtech(config)# interface loopback 0
Qtech(config if Loopback 0)# ip address 1.1.1.1 255.255.255.255
Qtech(config if Loopback 0)# exit
```

Configure OSPF protocol and establish the public network route.

```
Qtech(config)# router ospf 10
Qtech(config router)# network 1.1.1.1 0.0.0.0 area 0
Qtech(config router)# network 20.20.20.0 0.0.0.255 area 0
Qtech(config router)# exit
```

Configure LDP protocol and enable MPLS globally.

```
Qtech(config)# mpls ip
Qtech(config)# mpls router ldp
Qtech(config mpls router)# ldp router id interface loopback 0 force
Qtech(config mpls router)# neighbor 3.3.3.3
Qtech(config mpls router)# exit
```

Enable LDP and MPLS on the public network interface.

```
Qtech(config)# interface gigabitEthernet 3/2
```

```
Qtech(config if GigabitEthernet 3/2)# ip ref
Qtech(config if GigabitEthernet 3/2)# ip address 20.20.20.1 255.255.255.0
Qtech(config if GigabitEthernet 3/2)# mpls ip
Qtech(config if GigabitEthernet 3/2)# label switching
Qtech(config if GigabitEthernet 3/2)# exit
```

Configure a VPLS instance and specify the peer PE.

```
Qtech(config)# l2 vfi vfi_a vpnid 1
Qtech(config vpls)# neighbor 3.3.3.3 encapsulation mpls ethernet
Qtech(config vpls)# exit
```

Configure the interface that connects PEs and CEs to bind the VPLS instance.

```
Qtech(config)# interface gigabitEthernet 0/1
Qtech(config if GigabitEthernet 0/1)# ip ref
Qtech(config if GigabitEthernet 0/1)# xconnect vfi vfi_a
Qtech(config if GigabitEthernet 0/1)# exit
```

P:

Configure Loopback interface address.

```
Qtech(config)# interface loopback 0
Qtech(config if Loopback 0)# ip address 2.2.2.2 255.255.255.255
Qtech(config if Loopback 0)# exit
```

Configure OSPF protocol and establish the public network route.

```
Qtech(config)# router ospf 10
Qtech(config router)# network 2.2.2.2 0.0.0.0 area 0
Qtech(config router)# network 20.20.20.0 0.0.0.255 area 0
Qtech(config router)# network 30.30.30.0 0.0.0.255 area 0
Qtech(config router)# exit
```

Configure LDP protocol and enable MPLS globally.

```
Qtech(config)# mpls ip
Qtech(config)# mpls router ldp
Qtech(config mpls router)# ldp router id interface loopback 0 force
Qtech(config mpls router)# exit
```

Enable LDP and MPLS on the interface.

```
Qtech(config)# interface gigabitEthernet 3/1
Qtech(config if GigabitEthernet 3/1)# ip ref
Qtech(config if GigabitEthernet 3/1)# ip address 20.20.20.2 255.255.255.0
Qtech(config if GigabitEthernet 3/1)# mpls ip
Qtech(config if GigabitEthernet 3/1)# label switching
Qtech(config if GigabitEthernet 3/1)# exit
Qtech(config)# interface gigabitEthernet 3/2
Qtech(config if GigabitEthernet 3/2)# ip ref
```

```
Qtech(config if GigabitEthernet 3/2)# ip address 30.30.30.1 255.255.255.0
Qtech(config if GigabitEthernet 3/2)# mpls ip
Qtech(config if GigabitEthernet 3/2)# label switching
Qtech(config if GigabitEthernet 3/2)# exit
```

PE2:

Configure Loopback interface address.

```
Qtech(config)# interface loopback 0
Qtech(config if Loopback 0)# ip address 3.3.3.3 255.255.255.255
Qtech(config if Loopback 0)# exit
```

Configure OSPF protocol and establish the public network route.

```
Qtech(config)# router ospf 10
Qtech(config router)# network 3.3.3.3 0.0.0.0 area 0
Qtech(config router)# network 30.30.30.0 0.0.0.255 area 0
Qtech(config router)# exit
```

Configure LDP protocol and enable MPLS globally.

```
Qtech(config)# mpls ip
Qtech(config)# mpls router ldp
Qtech(config mpls router)# ldp router id interface loopback 0 force
Qtech(config mpls router)# neighbor 1.1.1.1
Qtech(config mpls router)# exit
```

Enable LDP and MPLS on the public network interface.

```
Qtech(config)# interface gigabitEthernet 3/1
Qtech(config if GigabitEthernet 3/1)# ip ref
Qtech(config if GigabitEthernet 3/1)# ip address 30.30.30.2 255.255.255.0
Qtech(config if GigabitEthernet 3/1)# mpls ip
Qtech(config if GigabitEthernet 3/1)# label switching
Qtech(config if GigabitEthernet 3/1)# exit
```

Configure a VPLS instance and specify the peer PE.

```
Qtech(config)# 12 vfi vfi_a vpnid 1
Qtech(config vpls)# neighbor 1.1.1.1 encapsulation mpls ethernet
Qtech(config vpls)# exit
```

Configure the interface that connects PEs and CEs to bind the VPLS instance.

```
Qtech(config)# interface gigabitEthernet 0/1
Qtech(config if GigabitEthernet 0/1)# ip ref
Qtech(config if GigabitEthernet 0/1)# xconnect vfi vfi_a
Qtech(config if GigabitEthernet 0/1)# exit
```

2.4.2.2 Basic VPLS (Ethernet sub-interface access)

As shown in the following figure, CE1 and CE2 access the same VPLS network through PE1 and PE2. PE1, P, and PE2 form a public MPLS network to provide VPLS services. VLAN 10 is bound on PE1 and PE2 to the VPLS instance.

Figure 1-40

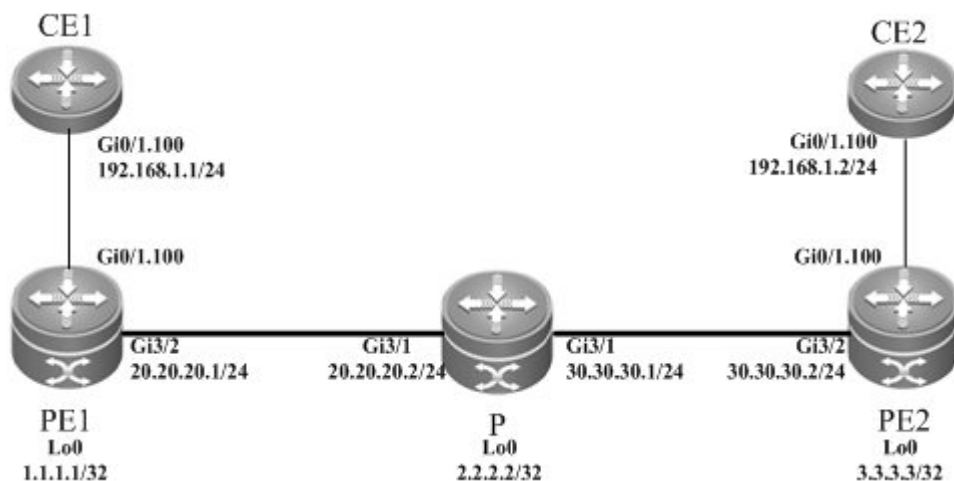

The configuration process is described as follows:

PE1:

Configure Loopback interface address.

```
Qtech(config)# interface loopback 0
Qtech(config if Loopback 0)# ip address 1.1.1.1 255.255.255.255
Qtech(config if Loopback 0)# exit
```

Configure OSPF protocol and establish the public network route.

```
Qtech(config)# router ospf 10
Qtech(config router)# network 1.1.1.1 0.0.0.0 area 0
Qtech(config router)# network 20.20.20.0 0.0.0.255 area 0
Qtech(config router)# exit
```

Configure LDP protocol and enable MPLS globally.

```
Qtech(config)# mpls ip
Qtech(config)# mpls router ldp
Qtech(config mpls router)# ldp router id interface loopback 0 force
Qtech(config mpls router)# neighbor 3.3.3.3
Qtech(config mpls router)# exit
```

Enable LDP and MPLS on the public network interface.

```
Qtech(config)# interface gigabitEthernet 3/2
Qtech(config if GigabitEthernet 3/2)# ip ref
```

```
Qtech(config if GigabitEthernet 3/2)# ip address 20.20.20.1 255.255.255.0
Qtech(config if GigabitEthernet 3/2)# mpls ip
Qtech(config if GigabitEthernet 3/2)# label switching
Qtech(config if GigabitEthernet 3/2)# exit
```

Configure a VPLS instance and specify the peer PE.

```
Qtech(config)# 12 vfi vfi_a vpnid 1
Qtech(config vpls)# neighbor 3.3.3.3 encapsulation mpls ethernetvlan
Qtech(config vpls)# exit
```

Configure the interface that connects PEs and CEs to bind the VPLS instance.

```
Qtech(config)# interface gigabitEthernet 0/1
Qtech(config if GigabitEthernet 0/1)# ip ref
Qtech(config if GigabitEthernet 0/1)# exit
Qtech(config)# interface gigabitEthernet 0/1.100
Qtech(config if GigabitEthernet 0/1.100)# encapsulation dot1Q 100
Qtech(config if GigabitEthernet 0/1.100)# xconnect vfi vfi_a
Qtech(config if GigabitEthernet 0/1.100)# exit
```

P:

Configure Loopback interface address.

```
Qtech(config)# interface loopback 0
Qtech(config if Loopback 0)# ip address 2.2.2.2 255.255.255.255
Qtech(config if Loopback 0)# exit
```

Configure OSPF protocol and establish the public network route.

```
Qtech(config)# router ospf 10
Qtech(config router)# network 2.2.2.2 0.0.0.0 area 0
Qtech(config router)# network 20.20.20.0 0.0.0.255 area 0
Qtech(config router)# network 30.30.30.0 0.0.0.255 area 0
Qtech(config router)# exit
```

Configure LDP protocol and enable MPLS globally.

```
Qtech(config)# mpls ip
Qtech(config)# mpls router ldp
Qtech(config mpls router)# ldp router id interface loopback 0 force
Qtech(config mpls router)# exit
```

Enable LDP and MPLS on the interface.

```
Qtech(config)# interface gigabitEthernet 3/1
Qtech(config if GigabitEthernet 3/1)# ip ref
Qtech(config if GigabitEthernet 3/1)# ip address 20.20.20.2 255.255.255.0
Qtech(config if GigabitEthernet 3/1)# mpls ip
Qtech(config if GigabitEthernet 3/1)# label switching
Qtech(config if GigabitEthernet 3/1)# exit
```



```
Qtech(config)# interface gigabitEthernet 3/2
Qtech(config if GigabitEthernet 3/2)# ip ref
Qtech(config if GigabitEthernet 3/2)# ip address 30.30.30.1 255.255.255.0
Qtech(config if GigabitEthernet 3/2)# mpls ip
Qtech(config if GigabitEthernet 3/2)# label switching
Qtech(config if GigabitEthernet 3/2)# exit
```

PE2:

Configure Loopback interface address.

```
Qtech(config)# interface loopback 0
Qtech(config if Loopback 0)# ip address 3.3.3.3 255.255.255.255
Qtech(config if Loopback 0)# exit
```

Configure OSPF protocol and establish the public network route.

```
Qtech(config)# router ospf 10
Qtech(config router)# network 3.3.3.3 0.0.0.0 area 0
Qtech(config router)# network 30.30.30.0 0.0.0.255 area 0
Qtech(config router)# exit
```

Configure LDP protocol and enable MPLS globally.

```
Qtech(config)# mpls ip
Qtech(config)# mpls router ldp
Qtech(config mpls router)# ldp router id interface loopback 0 force
Qtech(config mpls router)# neighbor 1.1.1.1
Qtech(config mpls router)# exit
```

Enable LDP and MPLS on the public network interface.

```
Qtech(config)# interface gigabitEthernet 3/1
Qtech(config if GigabitEthernet 3/1)# ip ref
Qtech(config if GigabitEthernet 3/1)# ip address 30.30.30.2 255.255.255.0
Qtech(config if GigabitEthernet 3/1)# mpls ip
Qtech(config if GigabitEthernet 3/1)# label switching
Qtech(config if GigabitEthernet 3/1)# exit
```

Configure a VPLS instance and specify the peer PE.

```
Qtech(config)# 12 vfi vfi_a vpnid 1
Qtech(config vpls)# neighbor 1.1.1.1 encapsulation mpls ethernetvlan
Qtech(config vpls)# exit
```

Configure the interface that connects PEs and CEs to bind the VPLS instance.

```
Qtech(config)# interface gigabitEthernet 0/1
Qtech(config if GigabitEthernet 0/1)# ip ref
Qtech(config if GigabitEthernet 0/1)# exit
Qtech(config)# interface gigabitEthernet 0/1.100
Qtech(config if GigabitEthernet 0/1.100)# encapsulation dot1Q 100
```

```
Qtech(config if GigabitEthernet 0/1.100)# xconnect vfi vfi_a
Qtech(config if GigabitEthernet 0/1.100)# exit
```

H-VPLS (PW access)

Figure 1-41

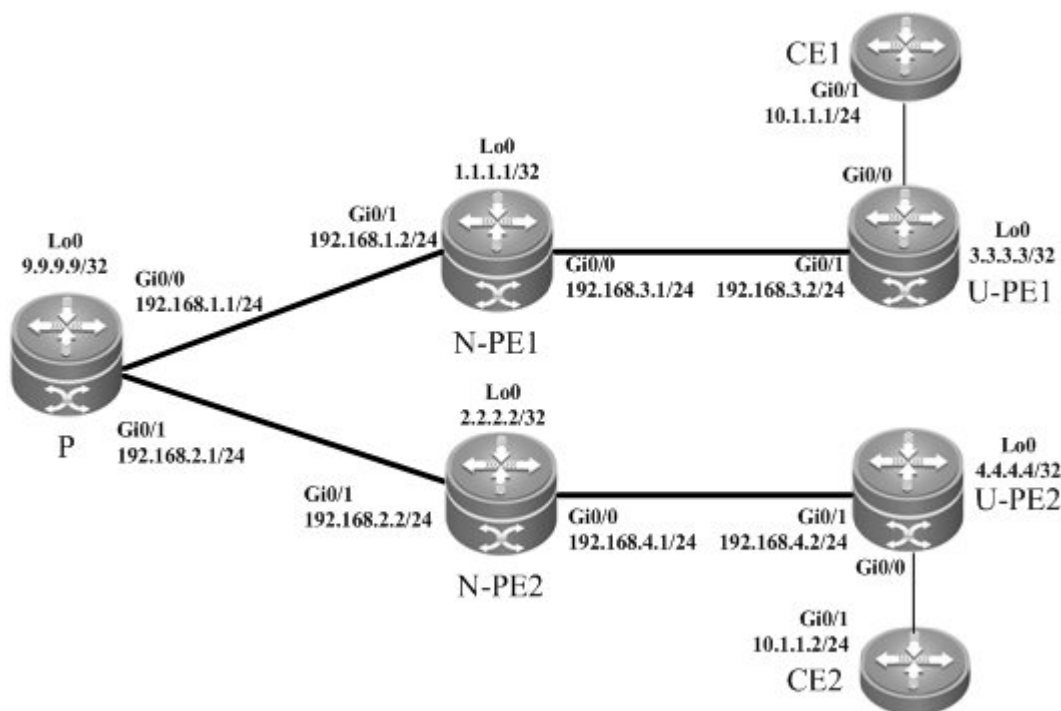

As shown in the above figure, CE1 and CE2 access to the same H-VPLS network through U-PE1 and U-PE2, U-PE1 and U-PE2 access to N-PE1 and N-PE2, and N-PE1 and N-PE2 access to check through PW. All the U-PEs and N-PEs belong to the MPLS network, and N-PEs and U-PEs jointly provide VPLS services.

When you set up PWs between N-PEs and U-PEs, you must specify the PW of the N-PEs with the U-PEs as a Spoke PW. On the U-PE end, the PW type is not restricted. If U-PEs support VPLS, the PW between U-PEs and N-PEs can be either a Hub PW or a Spoke PW. If the U-PEs do not support VPLS, the VPWS PW can also be configured.

In this example, U-PE1 and N-PE1 are connected through a Hub PW, while U-PE2 and N-PE2 are connected through a VPWS PW.

U-PE1:

Configure Loopback interface address.

```
Qtech(config)# interface loopback 0
Qtech(config if Loopback 0)# ip address 3.3.3.3 255.255.255.255
```

```
Qtech(config if Loopback 0)# exit
```

Configure OSPF protocol and establish the public network route.

```
Qtech(config)# router ospf 10
Qtech(config router)# network 3.3.3.3 0.0.0.0 area 0
Qtech(config router)# network 192.168.3.0 0.0.0.255 area 0
Qtech(config router)# exit
```

Configure LDP protocol and enable MPLS globally.

```
Qtech(config)# mpls ip
Qtech(config)# mpls router ldp
Qtech(config mpls router)# ldp router id interface loopback 0 force
Qtech(config mpls router)# neighbor 1.1.1.1
Qtech(config mpls router)# exit
```

Enable LDP and MPLS on the public network interface.

```
Qtech(config)# interface gigabitEthernet 0/1
Qtech(config if GigabitEthernet 0/1)# ip ref
Qtech(config if GigabitEthernet 0/1)# ip address 192.168.3.2 255.255.255.0
Qtech(config if GigabitEthernet 0/1)# mpls ip
Qtech(config if GigabitEthernet 0/1)# label switching
Qtech(config if GigabitEthernet 0/1)# exit
```

Configure a VPLS instance and configure PW to the peer N-PE

```
Qtech(config)# l2 vfi vfi_a vpnid 1
Qtech(config vpls)# neighbor 1.1.1.1 encapsulation mpls
Qtech(config vpls)# exit
```

Configure the interface that connects PEs and CEs to bind the VPLS instance.

```
Qtech(config)# interface gigabitEthernet 0/0
Qtech(config if GigabitEthernet 0/0)# ip ref
Qtech(config if GigabitEthernet 0/0)# exit
```

N-PE1:

Configure Loopback interface address.

```
Qtech(config)# interface loopback 0
Qtech(config if Loopback 0)# ip address 1.1.1.1 255.255.255.255
Qtech(config if Loopback 0)# exit
```

Configure OSPF protocol and establish the public network route.

```
Qtech(config)# router ospf 10
Qtech(config router)# network 1.1.1.1 0.0.0.0 area 0
Qtech(config router)# network 192.168.1.0 0.0.0.255 area 0
Qtech(config router)# network 192.168.3.0 0.0.0.255 area 0
Qtech(config router)# exit
```

Configure LDP protocol and enable MPLS globally.

```
Qtech(config)# mpls ip
Qtech(config)# mpls router ldp
Qtech(config mpls router)# ldp router id interface loopback 0 force
Qtech(config mpls router)# neighbor 2.2.2.2
Qtech(config mpls router)# neighbor 3.3.3.3
Qtech(config mpls router)# exit
```

Enable LDP and MPLS on the public network interface.

```
Qtech(config)# interface gigabitEthernet 0/1
Qtech(config if GigabitEthernet 0/1)# ip ref
Qtech(config if GigabitEthernet 0/1)# ip address 192.168.1.2 255.255.255.0
Qtech(config if GigabitEthernet 0/1)# mpls ip
Qtech(config if GigabitEthernet 0/1)# label switching
Qtech(config if GigabitEthernet 0/1)# exit
Qtech(config)# interface gigabitEthernet 0/0
Qtech(config if GigabitEthernet 0/0)# ip ref
Qtech(config if GigabitEthernet 0/0)# ip address 192.168.3.1 255.255.255.0
Qtech(config if GigabitEthernet 0/0)# mpls ip
Qtech(config if GigabitEthernet 0/0)# label switching
Qtech(config if GigabitEthernet 0/0)# exit
```

Configure a VPLS instance, a Hub PW to connect another N-PE, and the Spoke PW to connect the peer U-PE.

```
Qtech(config)# 12 vfi vfi_a vpnid 1
Qtech(config vpls)# neighbor 2.2.2.2 encapsulation mpls
Qtech(config vpls)# neighbor 3.3.3.3 encapsulation mpls spoke vc
Qtech(config vpls)# exit
```

P:

Configure Loopback interface address.

```
Qtech(config)# interface loopback 0
Qtech(config if Loopback 0)# ip address 9.9.9.9 255.255.255.255
Qtech(config if Loopback 0)# exit
```

Configure OSPF protocol and establish the public network route.

```
Qtech(config)# router ospf 10
Qtech(config router)# network 9.9.9.9 0.0.0.0 area 0
Qtech(config router)# network 192.168.1.0 0.0.0.255 area 0
Qtech(config router)# network 192.168.2.0 0.0.0.255 area 0
Qtech(config router)# exit
```

Configure LDP protocol and enable MPLS globally.

```
Qtech(config)# mpls ip
Qtech(config)# mpls router ldp
Qtech(config mpls router)# ldp router id interface loopback 0 force
Qtech(config mpls router)# exit
```

Enable LDP and MPLS on the interface.

```
Qtech(config)# interface gigabitEthernet 0/0
Qtech(config if GigabitEthernet 0/0)# ip ref
Qtech(config if GigabitEthernet 0/0)# ip address 192.168.1.1 255.255.255.0
Qtech(config if GigabitEthernet 0/0)# mpls ip
Qtech(config if GigabitEthernet 0/0)# label switching
Qtech(config if GigabitEthernet 0/0)# exit
Qtech(config)# interface gigabitEthernet 0/1
Qtech(config if GigabitEthernet 0/1)# ip ref
Qtech(config if GigabitEthernet 0/1)# ip address 192.168.2.1 255.255.255.0
Qtech(config if GigabitEthernet 0/1)# mpls ip
Qtech(config if GigabitEthernet 0/1)# label switching
Qtech(config if GigabitEthernet 0/1)# exit
```

N-PE2:

Configure Loopback interface address.

```
Qtech(config)# interface loopback 0
Qtech(config if Loopback 0)# ip address 2.2.2.2 255.255.255.255
Qtech(config if Loopback 0)# exit
```

Configure OSPF protocol and establish the public network route.

```
Qtech(config)# router ospf 10
Qtech(config router)# network 2.2.2.2 0.0.0.0 area 0
Qtech(config router)# network 192.168.2.0 0.0.0.255 area 0
Qtech(config router)# network 192.168.4.0 0.0.0.255 area 0
Qtech(config router)# exit
```

Configure LDP protocol and enable MPLS globally.

```
Qtech(config)# mpls ip
Qtech(config)# mpls router ldp
Qtech(config mpls router)# ldp router id interface loopback 0 force
Qtech(config mpls router)# neighbor 1.1.1.1
Qtech(config mpls router)# neighbor 4.4.4.4
Qtech(config mpls router)# exit
```

Enable LDP and MPLS on the public network interface.

```
Qtech(config)# interface gigabitEthernet 0/1
Qtech(config if GigabitEthernet 0/1)# ip ref
Qtech(config if GigabitEthernet 0/1)# ip address 192.168.2.2 255.255.255.0
```

```
Qtech(config if GigabitEthernet 0/1)# mpls ip
Qtech(config if GigabitEthernet 0/1)# label switching
Qtech(config if GigabitEthernet 0/1)# exit
Qtech(config)# interface gigabitEthernet 0/0
Qtech(config if GigabitEthernet 0/0)# ip ref
Qtech(config if GigabitEthernet 0/0)# ip address 192.168.4.1 255.255.255.0
Qtech(config if GigabitEthernet 0/0)# mpls ip
Qtech(config if GigabitEthernet 0/0)# label switching
Qtech(config if GigabitEthernet 0/0)# exit
```

Configure a VPLS instance, a Hub PW to connect another N-PE, and the Spoke PW to connect the peer U-PE.

```
Qtech(config)# l2 vfi vfi_a vpnid 1
Qtech(config vpls)# neighbor 1.1.1.1 encapsulation mpls
Qtech(config vpls)# neighbor 4.4.4.4 encapsulation mpls spoke vc
Qtech(config vpls)# exit
```

U-PE2:

Configure Loopback interface address.

```
Qtech(config)# interface loopback 0
Qtech(config if Loopback 0)# ip address 4.4.4.4 255.255.255.255
Qtech(config if Loopback 0)# exit
```

Configure OSPF protocol and establish the public network route.

```
Qtech(config)# router ospf 10
Qtech(config router)# network 4.4.4.4 0.0.0.0 area 0
Qtech(config router)# network 192.168.4.0 0.0.0.255 area 0
Qtech(config router)# exit
```

Configure LDP protocol and enable MPLS globally.

```
Qtech(config)# mpls ip
Qtech(config)# mpls router ldp
Qtech(config mpls router)# ldp router id interface loopback 0 force
Qtech(config mpls router)# neighbor 2.2.2.2
Qtech(config mpls router)# exit
```

Enable LDP and MPLS on the public network interface.

```
Qtech(config)# interface gigabitEthernet 0/1
Qtech(config if GigabitEthernet 0/1)# ip ref
Qtech(config if GigabitEthernet 0/1)# ip address 192.168.4.2 255.255.255.0
Qtech(config if GigabitEthernet 0/1)#mpls ip
Qtech(config if GigabitEthernet 0/1)# label switching
Qtech(config if GigabitEthernet 0/1)# exit
```

Configure the interface that connects PEs and CEs to enable VPWS.

```

Qttech(config)# interface gigabitEthernet 0/0
Qttech(config if GigabitEthernet 0/0)# ip ref
Qttech(config if GigabitEthernet 0/0)# xconnect 2.2.2.2 1 encapsulation mpls ethernet
Qttech(config if GigabitEthernet 0/0)# exit

```

2.4.3 Typical Examples of Kompella VPLS Configuration for Switches

2.4.3.1 Basic VPLS

Networking Requirements

- ❖ CE1 and CE2 access to the same VPLS network through PE1 and PE2;
- ❖ PE1, P and PE2 form the public network MPLS network;
- ❖ VLAN 10 is bound on PE1 and PE2 to the VPLS instance.

Topology

Figure 1-42

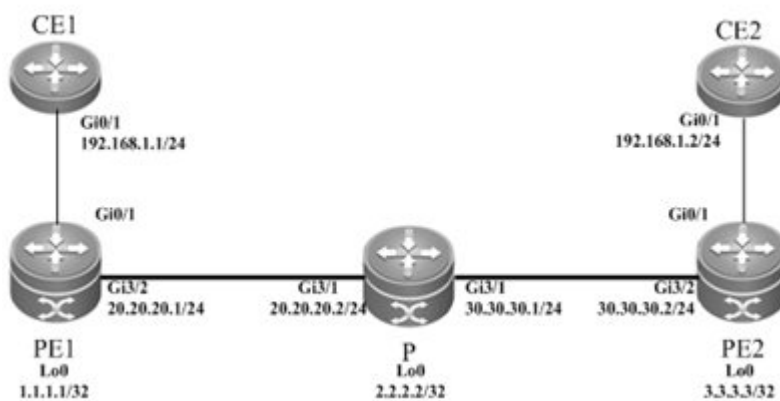

Notes

Before configuring Kompella VPLS, complete the following tasks:

- ❖ Run IGP in the carrier's network to realize connection between PE1 and PE2;
- ❖ Obtain Kompella VPLS configuration information including VPLS instance descriptive information, RT value, VE ID, maximum planned site number, VE ID deviation and interface from the network administrator.

Configuration Steps

PE1:

Configure Loopback interface address.

```

Qttech(config)# interface loopback 0
Qttech(config if Loopback 0)# ip address 1.1.1.1 255.255.255.255

```

```
Qtech(config if Loopback 0)# exit
```

Configure OSPF protocol and establish the public network route.

```
Qtech(config)# router ospf 10
Qtech(config router)# network 1.1.1.1 0.0.0.0 area 0
Qtech(config router)# network 20.20.20.0 0.0.0.255 area 0
Qtech(config router)# exit
```

Configure LDP protocol and enable MPLS globally.

```
Qtech(config)# mpls ip
Qtech(config)# mpls router ldp
Qtech(config mpls router)# ldp router id interface loopback 0 force
Qtech(config mpls router)# neighbor 3.3.3.3
Qtech(config mpls router)# exit
```

Enable LDP and MPLS on the public network interface.

```
Qtech(config)# interface gigabitEthernet 3/2
Qtech(config if GigabitEthernet 3/2)# no switchport
Qtech(config if GigabitEthernet 3/2)# ip address 20.20.20.1 255.255.255.0
Qtech(config if GigabitEthernet 3/2)# mpls ip
Qtech(config if GigabitEthernet 3/2)# label switching
Qtech(config if GigabitEthernet 3/2)# exit
```

Configure the Vlan interface.

```
Qtech(config)# vlan 10
Qtech(config vlan)# exit
```

Configure the L2VPN address family.

```
Qtech(config)# router bgp 100
Qtech(config router)# neighbor 3.3.3.3 remote as 100
Qtech(config router)# neighbor 3.3.3.3 update source loopback 0
Ruijie(config router)# address family l2vpn vpls
Qtech(config router af)# neighbor 3.3.3.3 activate
Qtech(config router af)# neighbor 3.3.3.3 send community extended
Qtech(config router af)# exit
```

Configure the interface that connects PEs and CEs.

```
Qtech(config)# interface gigabitEthernet 3/1
Qtech(config if GigabitEthernet 3/1)# switchport access vlan 10
Qtech(config if GigabitEthernet 3/1)# exit
```

Configure a VPLS instance.

```
Qtech# configure terminal
Qtech(config)# l2 vfi vpls 1 vpnid 1 autodiscovery
Qtech(config vfi)# rd 1:1
Qtech(config vfi)# signal bgp
```



```
Qtech(config vfi)# encapsulation mpls ethernet
Qtech(config vfi)# route target both 10000:1
Qtech(config vfi)# site id 1
Qtech(config vfi site)# xconnect interface vlan 10
Qtech(config vfi site)#exit site mode
Qtech(config vfi)# eixt
```

P:

Configure Loopback interface address.

```
Qtech(config)# interface loopback 0
Qtech(config if Loopback 0)# ip address 2.2.2.2 255.255.255.255
Qtech(config if Loopback 0)# exit
```

Configure OSPF protocol and establish the public network route.

```
Qtech(config)# router ospf 10
Qtech(config router)# network 2.2.2.2 0.0.0.0 area 0
Qtech(config router)# network 20.20.20.0 0.0.0.255 area 0
Qtech(config router)# network 30.30.30.0 0.0.0.255 area 0
Qtech(config router)# exit
```

Configure LDP protocol and enable MPLS globally.

```
Qtech(config)# mpls ip
Qtech(config)# mpls router ldp
Qtech(config mpls router)# ldp router id interface loopback 0 force
Qtech(config mpls router)# exit
```

Enable LDP and MPLS on the interface.

```
Qtech(config)# interface gigabitEthernet 3/1
Qtech(config if GigabitEthernet 3/1)# no switchport
Qtech(config if GigabitEthernet 3/1)# ip address 20.20.20.2 255.255.255.0
Qtech(config if GigabitEthernet 3/1)# mpls ip
Qtech(config if GigabitEthernet 3/1)# label switching
Qtech(config if GigabitEthernet 3/1)# exit
Qtech(config)# interface gigabitEthernet 3/2
Qtech(config if GigabitEthernet 3/2)# no switchport
Qtech(config if GigabitEthernet 3/2)# ip address 30.30.30.1 255.255.255.0
Qtech(config if GigabitEthernet 3/2)# mpls ip
Qtech(config if GigabitEthernet 3/2)# label switching
Qtech(config if GigabitEthernet 3/2)# exit
```

PE2:

Configure Loopback interface address.

```
Qtech(config)# interface loopback 0
Qtech(config if Loopback 0)# ip address 3.3.3.3 255.255.255.255
```

```
Qtech(config if Loopback 0)# exit
```

Configure OSPF protocol and establish the public network route.

```
Qtech(config)# router ospf 10
Qtech(config router)# network 3.3.3.3 0.0.0.0 area 0
Qtech(config router)# network 30.30.30.0 0.0.0.255 area 0
Qtech(config router)# exit
```

Configure LDP protocol and enable MPLS globally.

```
Qtech(config)# mpls ip
Qtech(config)# mpls router ldp
Qtech(config mpls router)# ldp router id interface loopback 0 force
Qtech(config mpls router)# neighbor 1.1.1.1
Qtech(config mpls router)# exit
```

Enable LDP and MPLS on the public network interface.

```
Qtech(config)# interface gigabitEthernet 3/1
Qtech(config if GigabitEthernet 3/1)# no switchport
Qtech(config if GigabitEthernet 3/1)# ip address 30.30.30.2 255.255.255.0
Qtech(config if GigabitEthernet 3/1)# mpls ip
Qtech(config if GigabitEthernet 3/1)# label switching
Qtech(config if GigabitEthernet 3/1)# exit
```

Configure the L2VPN address family.

```
Qtech(config)# router bgp 100
Qtech(config router)# neighbor 1.1.1.1 remote as 100
Qtech(config router)# neighbor 1.1.1.1 update source loopback 0
Ruijie(config router)# address family l2vpn vpls
Qtech(config router af)# neighbor 1.1.1.1 activate
Qtech(config router af)# neighbor 1.1.1.1 send community extended
Qtech(config router af)# exit
```

Configure the Vlan interface.

```
Qtech(config)# vlan 10
Qtech(config vlan)# exit
```

Configure the interface that connects PEs and CEs.

```
Qtech(config)# interface gigabitEthernet 3/2
Qtech(config if GigabitEthernet 3/2)# switchport access vlan 10
Qtech(config if GigabitEthernet 3/2)# exit
```

Configure a VPLS instance.

```
Qtech# configure terminal
Qtech(config)# l2 vfi vpls 1 vpnid 1 autodiscovery
Qtech(config vfi)# rd 1:1
Qtech(config vfi)# signal bgp
```

```

Qtech(config vfi)# encapsulation mpls ethernet
Qtech(config vfi)# route target both 10000:1
Qtech(config vfi)# site id 2
Qtech(config vfi site)# xconnect interface vlan 10
Qtech(config vfi site)# exit site mode
Qtech(config vfi)# exit

```

2.4.3.2 Inter-AS Configuration Examples – Option A Solution

Networking Requirements

- ❖ LAN segments of customer S in Site A and Site B are connected with each other through the carrier's PE1 in AS100 and PE2 in AS 200, forming a virtual and simulative LAN service, or VPLS service;
- ❖ PE1 and PE2 are in different autonomous domains. ASBR 1 and ASBR 2 are considered CE devices by each other, which means the interface between ASBRs connects AC to VPLS instance;

Topology

Figure 1-43 Kompella VPLS Inter-AS networking topology

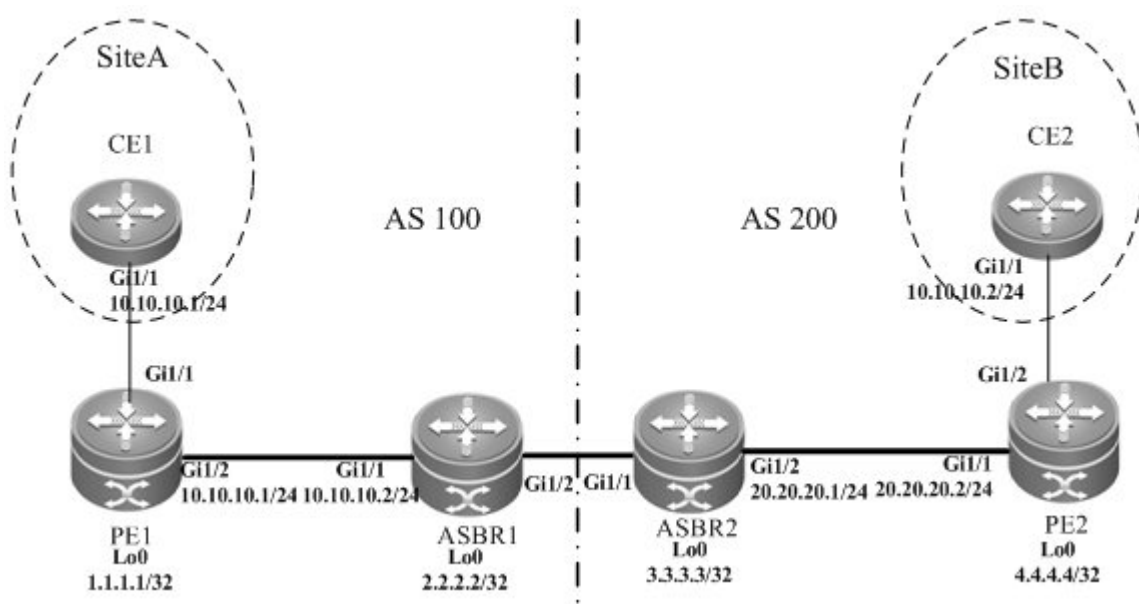

The above figure shows the structure of the Kompella VPLS Inter-AS networking topology in Option A. The intermediate interface is considered by ASBRs as AC connection.

Notes

Before configuring Kompella VPLS, complete the following tasks:

- ❖ Run IGP in the carrier's network to realize connection between PE and ASBR devices;

- ❖ Establish MP-IBGP peer relationship between PEs and ASBRs in the domain;
- ❖ Obtain Kompella VPLS configuration information including VPLS instance descriptive information, RT value, VE ID, maximum planned site number, VE ID deviation and interface from the network administrator.

Configuration Steps

- ❖ Configuring CE1

See "Configuring CE1" in basic configuration examples.

- ❖ Configuring PE1

Configure Loopback interface address.

```
Qttech(config)# interface loopback 0
Qttech(config if Loopback 0)# ip address 1.1.1.1 255.255.255.255
Qttech(config if Loopback 0)# exit
```

Configure OSPF protocol, establish the public network route so that PEs can ping with ASBRs in the same domain.

```
Qttech(config)# router ospf 10
Qttech(config router)# network 1.1.1.1 0.0.0.0 area 0
Qttech(config router)# network 10.10.10.0 0.0.0.255 area 0
Qttech(config router)# exit
```

Configure LDP protocol and enable MPLS globally.

```
Qttech(config)# mpls ip
Qttech(config)# mpls router ldp
Qttech(config mpls router)# ldp router id interface loopback 0 force
Qttech(config mpls router)# exit
```

#Configure the public network tunnel between PEs.

```
Qttech(config)# interface gigabitEthernet 1/2
Qttech(config if GigabitEthernet 1/2)# ip address 10.10.10.1 255.255.255.0
Qttech(config if GigabitEthernet 1/2)# mpls ip
Qttech(config if GigabitEthernet 1/2)# label switching
Qttech(config if GigabitEthernet 1/2)# exit
```

Configure the L2VPN address family.

```
Qttech(config)# router bgp 100
Qttech(config router)# neighbor 2.2.2.2 remote as 100
Qttech(config router)# neighbor 2.2.2.2 update source loopback 0
Ruiije(config router)# address family l2vpn vpls
Qttech(config router af)# neighbor 2.2.2.2 activate
Qttech(config router af)# neighbor 2.2.2.2 send community extended
```

```
Qtech(config router af)# exit
```

Configure the Vlan interface.

```
Qtech(config)# vlan 10
```

```
Qtech(config vlan)# exit
```

Configure the CE-PE interface.

```
Qtech(config)# interface gigabitEthernet 1/1
```

```
Qtech(config if GigabitEthernet 1/1)# switchport access vlan 10
```

```
Qtech(config if GigabitEthernet 1/1)# exit
```

Configure a VPLS instance.

```
Qtech# configure terminal
```

```
Qtech(config)# 12 vfi vpls 1 vpnid 1 autodiscovery
```

```
Qtech(config vfi)# rd 100:1
```

```
Qtech(config vfi)# signal bgp
```

```
Qtech(config vfi)# encapsulation mpls ethernet
```

```
Qtech(config vfi)# route target both 10000:1
```

```
Qtech(config vfi)# site id 1
```

```
Qtech(config vfi site)# xconnect interface vlan 10
```

```
Qtech(config vfi site)#exit site mode
```

❖ Configuring ASBR 1

Configure Loopback interface address.

```
Qtech(config)# interface loopback 0
```

```
Qtech(config if Loopback 0)# ip address 2.2.2.2 255.255.255.255
```

```
Qtech(config if Loopback 0)# exit
```

Configure OSPF protocol, establish the public network route so that PEs can ping with ASBRs in the same domain.

```
Qtech(config)# router ospf 10
```

```
Qtech(config router)# network 2.2.2.2 0.0.0.0 area 0
```

```
Qtech(config router)# network 10.10.10.0 0.0.0.255 area 0
```

```
Qtech(config router)# exit
```

Configure LDP protocol and enable MPLS globally.

```
Qtech(config)# mpls ip
```

```
Qtech(config)# mpls router ldp
```

```
Qtech(config mpls router)# ldp router id interface loopback 0 force
```

```
Qtech(config mpls router)# exit
```

#Configure the public network tunnel between PEs.

```
Qtech(config)# interface gigabitEthernet 1/1
```

```
Qtech(config if GigabitEthernet 1/1)# ip address 10.10.10.2 255.255.255.0
```

```
Qtech(config if GigabitEthernet 1/1)# mpls ip
```

```
Qtech(config if GigabitEthernet 1/1)# label switching
Qtech(config if GigabitEthernet 1/1)# exit
```

Configure the L2VPN address family.

```
Qtech(config)# router bgp 100
Qtech(config router)# neighbor 1.1.1.1 remote as 100
Qtech(config router)# neighbor 1.1.1.1 update source loopback 0
Ruiije(config router)# address family l2vpn vpls
Qtech(config router af)# neighbor 1.1.1.1 activate
Qtech(config router af)# neighbor 1.1.1.1 send community extended
Qtech(config router af)# exit
```

Configure the Vlan interface.

```
Qtech(config)# vlan 10
Qtech(config vlan)# exit
```

Configure the interface that connects ASBR 1 and ASBR 2.

```
Qtech(config)# interface gigabitEthernet 1/2
Qtech(config if GigabitEthernet 1/2)# switchport access vlan 10
Qtech(config if GigabitEthernet 1/2)# exit
```

Configure a VPLS instance.

```
Qtech# configure terminal
Qtech(config)# l2 vfi vpls 1 vpnid 1 autodiscovery
Qtech(config vfi)# rd 100:1
Qtech(config vfi)# signal bgp
Qtech(config vfi)# encapsulation mpls ethernet
Qtech(config vfi)# route target both 10000:1
Qtech(config vfi)# mtu 1500
Qtech(config vfi)# site id 2
Qtech(config vfi site)# xconnect interface vlan 10
Qtech(config vfi site)#exit site mode
Qtech(config vfi)#exit
```

❖ Configuring ASBR 2

Configure Loopback interface address.

```
Qtech(config)# interface loopback 0
Qtech(config if Loopback 0)# ip address 3.3.3.3 255.255.255.255
Qtech(config if Loopback 0)# exit
```

Configure OSPF protocol, establish the public network route so that PEs can ping with ASBRs in the same domain.

```
Qtech(config)# router ospf 10
Qtech(config router)# network 3.3.3.3 0.0.0.0 area 0
```

```
Qtech(config router)# network 20.20.20.0 0.0.0.255 area 0
Qtech(config router)# exit
```

Configure LDP protocol and enable MPLS globally.

```
Qtech(config)# mpls ip
Qtech(config)# mpls router ldp
Qtech(config mpls router)# ldp router id interface loopback 0 force
Qtech(config mpls router)# exit
```

Configure the public network tunnel between PEs.

```
Qtech(config)# interface gigabitEthernet 1/2
Qtech(config if GigabitEthernet 1/2)# ip address 20.20.20.2 255.255.255.0
Qtech(config if GigabitEthernet 1/2)# mpls ip
Qtech(config if GigabitEthernet 1/2)# label switching
Qtech(config if GigabitEthernet 1/2)# exit
```

Configure the L2VPN address family.

```
Qtech(config)# router bgp 200
Qtech(config router)# neighbor 4.4.4.4 remote as 200
Qtech(config router)# neighbor 4.4.4.4 update source loopback 0
Ruijie(config router)# address family l2vpn vpls
Qtech(config router af)# neighbor 4.4.4.4 activate
Qtech(config router af)# neighbor 4.4.4.4 send community extended
Qtech(config router af)# exit
```

Configure the Vlan interface.

```
Qtech(config)# vlan 10
Qtech(config vlan)# exit
```

Configure the interface that connects ASBR 1 and ASBR 2.

```
Qtech(config)# interface gigabitEthernet 1/1
Qtech(config if GigabitEthernet 1/1)# switchport access vlan 10
Qtech(config if GigabitEthernet 1/1)# exit
```

Configure a VPLS instance.

```
Qtech# configure terminal
Qtech(config)# l2 vfi vpls 1 vpnid 1 autodiscovery
Qtech(config vfi)# rd 200:1
Qtech(config vfi)# signal bgp
Qtech(config vfi)# encapsulation mpls ethernet
Qtech(config vfi)# route target both 10000:1
Qtech(config vfi)# site id 3
Qtech(config vfi site)# xconnect interface vlan 10
Qtech(config vfi site)#exit site mode
Qtech(config vfi)#exit
```

❖ Configuring PE2

Configure Loopback interface address.

```
Qtech(config)# interface loopback 0
Qtech(config if Loopback 0)# ip address 4.4.4.4 255.255.255.255
Qtech(config if Loopback 0)# exit
```

Configure OSPF protocol, establish the public network route so that PEs can ping with ASBRs in the same domain.

```
Qtech(config)# router ospf 10
Qtech(config router)# network 4.4.4.4 0.0.0.0 area 0
Qtech(config router)# network 20.20.20.0 0.0.0.255 area 0
Qtech(config router)# exit
```

Configure LDP protocol and enable MPLS globally.

```
Qtech(config)# mpls ip
Qtech(config)# mpls router ldp
Qtech(config mpls router)# ldp router id interface loopback 0 force
Qtech(config mpls router)# exit
```

Configure the public network tunnel between PEs.

```
Qtech(config)# interface gigabitEthernet 1/1
Qtech(config if GigabitEthernet 1/1)# ip address 20.20.20.1 255.255.255.0
Qtech(config if GigabitEthernet 1/1)# mpls ip
Qtech(config if GigabitEthernet 1/1)# label switching
Qtech(config if GigabitEthernet 1/1)# exit
```

Configure the L2VPN address family.

```
Qtech(config)# router bgp 200
Qtech(config router)# neighbor 3.3.3.3 remote as 200
Qtech(config router)# neighbor 3.3.3.3 update source loopback 0
Ruijie(config router)# address family l2vpn vpls
Qtech(config router af)# neighbor 3.3.3.3 activate
Qtech(config router af)# neighbor 3.3.3.3 send community extended
Qtech(config router af)# exit
```

Configure the Vlan interface.

```
Qtech(config)# vlan 10
Qtech(config vlan)# exit
```

Configure the interface that connects PE 2 and CE.

```
Qtech(config)# interface gigabitEthernet 1/2
Qtech(config if GigabitEthernet 1/2)# switchport access vlan 10
Qtech(config if GigabitEthernet 1/2)# exit
```

Configure a VPLS instance.

```

Qttech# configure terminal
Qttech(config)# l2 vfi vpls 1 vpnid 1 autodiscovery
Qttech(config vfi)# rd 200:1
Qttech(config vfi)# signal bgp
Qttech(config vfi)# encapsulation mpls ethernet
Qttech(config vfi)# route target both 10000:1
Qttech(config vfi)# site id 4
Qttech(config vfi site)# xconnect interface vlan 10
Qttech(config vfi site)#exit site mode
Qttech(config vfi)#exit

```

Configuring CE2

See "Configuring CE2" in basic configuration examples.

Displaying verification

After the configuration, CE 1 can ping with CE 2.

After completing the configuration of Kompella VPLS, use the following commands to check the operation of VPLS.

Command	Function
Qttech# show bgp l2vpn vpls all	Display all the VPLS information.
Qttech# show mpls l2transport vc [vc_id [ip-address]] [interface interface_name] [detail]	Display information about PW (including VPWS PW and VPLS PW)
Qttech# show bgp l2vpn { vpls vpws } all connections [neighbor address] [interface interface_name] [site-id id] [detail]	Display VPLS-PW's information.
Qttech# show mpls vfi [name]	Display all the configured or specified VFI information.

2.4.3.3 Inter-AS Configuration Examples – Option C Solution

Networking Requirements

- ❖ LAN segments of customer S in Site A and Site B are connected with each other through the carrier's PE1 in AS 1 and PE2 in AS 2, forming a virtual and simulative LAN service, or VPLS service;
- ❖ PE1 and PE2 are in different autonomous domains and can automatically detect PE devices that join in the VPLS instance;
- ❖ ASBR is not responsible for maintaining VPLS label block messages;
- ❖ VPLS label block messages are directly switched between PEs.

Topology

Figure 1-44 Kompella VPLS Option C Inter-AS networking topology

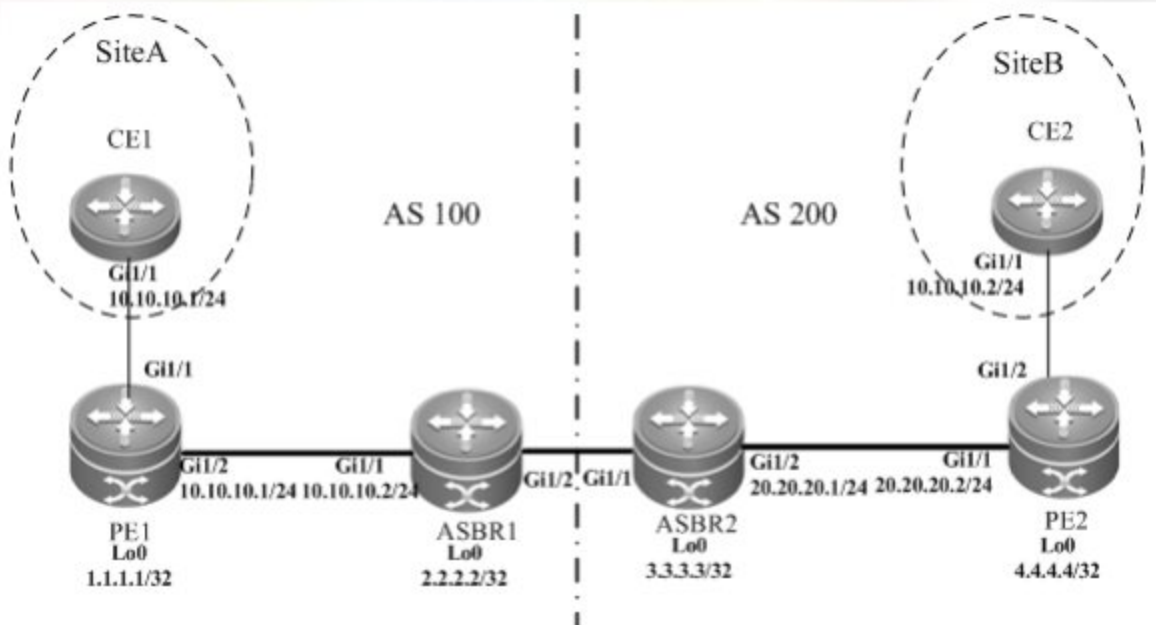

The above figure shows the structure of Kompella VPLS Option C Inter-AS networking topology. Customer S's LAN segments in Site A and Site B are connected to each other through PE1 in AS100 and PE2 in AS200 as one LAN.

Notes

Before configuring Kompella VPLS, complete the following tasks:

- ❖ Run IGP in the carrier's network to realize connection between VPLS-PE and ASBR devices in the same AS;
- ❖ Establish a public network tunnel between PE and ASBR devices in the same domain and enable MPLS on the ASBR interface;
- ❖ Establish IBGP between PE and ASBR in the same domain;
- ❖ Establish EBGP between ASBR devices and enable send-label;
- ❖ Obtain Kompella VPLS configuration information including VPLS instance descriptive information, RT value, VE ID, planned site number, VE ID deviation and interface from the network administrator.



Caution

When Option C (Multihop MP-EBGP) is applied to realize Inter-AC Kompella L2VPN applications, if the MP-EBGP connection is set up by the route reflector between autonomous domains to switch NLRI information of L2VPN, the next hop will be changed into itself by default when such information is sent to the peer EBGP. To realize the Kompella L2VPN through Option C solution, the **neighbor next-hop-unchanged** command must be configured on the route reflector so that the reflector will not change the next hop when NLRI information is sent. Otherwise, the Inter-AS forwarding will fail.

Configuration Steps

❖ Configuring CE1

See "Configuring CE1" in basic configuration examples.

❖ Configuring PE1

Configure Loopback interface address.

```
Qtech(config)# interface loopback 0
Qtech(config if Loopback 0)# ip address 1.1.1.1 255.255.255.255
Qtech(config if Loopback 0)# exit
```

Configure OSPF protocol and establish the public network route.

```
Qtech(config)# router ospf 10
Qtech(config router)# network 1.1.1.1 0.0.0.0 area 0
Qtech(config router)# network 10.10.10.0 0.0.0.255 area 0
Qtech(config router)# exit
Qtech(config router)# exit
```

Configure LDP protocol and enable MPLS globally.

```
Qtech(config)# mpls ip
Qtech(config)# mpls router ldp
Qtech(config mpls router)# ldp router id interface loopback 0 force
Qtech(config mpls router)# exit
```

Configure the public network tunnel between PEs.

```
Qtech(config)# interface gigabitEthernet 1/2
Qtech(config if GigabitEthernet 1/2)# ip address 10.10.10.1 255.255.255.0
Qtech(config if GigabitEthernet 1/2)# mpls ip
Qtech(config if GigabitEthernet 1/2)# label switching
Qtech(config if GigabitEthernet 1/2)# exit
```

Configure the L2VPN address family.

```
Qtech(config)# router bgp 100
Qtech(config router)# neighbor 4.4.4.4 remote as 200
Qtech(config router)# neighbor 4.4.4.4 update source loopback 0
Qtech(config router)# neighbor 4.4.4.4 ebgp multihop
Qtech(config router)# address family ipv4
Qtech(config router af)# no neighbor 4.4.4.4 activate
Qtech(config router af)# exit
Ruiije(config router)# address family l2vpn vpls
Qtech(config router af)# neighbor 4.4.4.4 activate
Qtech(config router af)# neighbor 4.4.4.4 send community extended
```

```
Qttech(config router af)# exit
```

Configure the Vlan interface.

```
Qttech(config)# vlan 10  
Qttech(config vlan)# exit
```

Configure the interface that connects CEs.

```
Qttech(config)# interface gigabitEthernet 1/1  
Qttech(config if GigabitEthernet 1/1)# switchport access vlan 10  
Qttech(config if GigabitEthernet 1/1)# exit
```

Configure a VPLS instance.

```
Qttech# configure terminal  
Qttech(config)# 12 vfi vpls 1 vpnid 1 autodiscovery  
Qttech(config vfi)# rd 100:1  
Qttech(config vfi)# signal bgp  
Qttech(config vfi)# encapsulation mpls ethernet  
Qttech(config vfi)# route target both 10000:1  
Qttech(config vfi)# site id 1  
Qttech(config vfi site)# xconnect interface vlan 10  
Qttech(config vfi site)#exit site mode  
Qttech(config vfi)#exit
```

❖ Configuring ASBR 1

Configure Loopback interface address.

```
Qttech(config)# interface loopback 0  
Qttech(config if Loopback 0)# ip address 2.2.2.2 255.255.255.255  
Qttech(config if Loopback 0)# exit
```

Configure OSPF protocol and establish the public network route.

```
Qttech(config)# router ospf 10  
Qttech(config router)# redistribute bgp subnets  
Qttech(config router)# network 2.2.2.2 0.0.0.0 area 0  
Qttech(config router)# network 10.10.10.0 0.0.0.255 area 0  
Qttech(config router)# exit
```

Configure LDP protocol and enable MPLS globally.

```
Qttech(config)# mpls ip  
Qttech(config)# mpls router ldp  
Qttech(config mpls router)# ldp router id interface loopback 0 force  
Qttech(config mpls router)# advertise labels for bgp routes  
Qttech(config mpls router)# exit
```

#Configure the public network tunnel between PEs.

```
Qtech(config)# interface gigabitEthernet 1/1
Qtech(config if GigabitEthernet 1/1)# ip address 10.10.10.2 255.255.255.0
Qtech(config if GigabitEthernet 1/1)# mpls ip
Qtech(config if GigabitEthernet 1/1)# label switching
Qtech(config if GigabitEthernet 1/1)# exit
```

Configure the interface that connects ASBRs.

```
Qtech(config)# interface gigabitEthernet 1/2
Qtech(config if GigabitEthernet 1/2)# ip address 192.168.1.1 255.255.255.252
Qtech(config if GigabitEthernet 1/2)# label switching
Qtech(config if GigabitEthernet 1/2)# exit
```

Configure ASBR to allocate labels for PEs' routes.

```
Qtech(config)# router bgp 100
Qtech(config router)# neighbor 192.168.1.2 remote as 200
Qtech(config router)# address family ipv4
Qtech(config router af)# neighbor 192.168.1.2 send label
Qtech(config router af)# network 1.1.1.1 mask 255.255.255.255
Qtech(config router af)# end
```

❖ Configuring ASBR 2

Configure Loopback interface address.

```
Qtech(config)# interface loopback 0
Qtech(config if Loopback 0)# ip address 3.3.3.3 255.255.255.255
Qtech(config if Loopback 0)# exit
```

Configure OSPF protocol and establish the public network route.

```
Qtech(config)# router ospf 20
Qtech(config router)# redistribute bgp subnets
Qtech(config router)# network 3.3.3.3 0.0.0.0 area 0
Qtech(config router)# network 20.20.20.0 0.0.0.255 area 0
Qtech(config router)# exit
```

Configure LDP protocol and enable MPLS globally.

```
Qtech(config)# mpls ip
Qtech(config)# mpls router ldp
Qtech(config mpls router)# ldp router id interface loopback 0 force
Qtech(config mpls router)# advertise labels for bgp routes
Qtech(config mpls router)# exit
```

Configure the public network tunnel between PEs.

```
Qtech(config)# interface gigabitEthernet 1/2
Qtech(config if GigabitEthernet 1/2)# ip address 20.20.20.2 255.255.255.0
Qtech(config if GigabitEthernet 1/2)# mpls ip
```

```
Qtech(config if GigabitEthernet 1/2)# label switching
Qtech(config if GigabitEthernet 1/2)# exit
```

Configure the interface that connects ASBRs.

```
Qtech(config)# interface gigabitEthernet 1/1
Qtech(config if GigabitEthernet 1/1)# ip address 192.168.1.1 255.255.255.252
Qtech(config if GigabitEthernet 1/1)# label switching
Qtech(config if GigabitEthernet 1/1)# exit
```

Configure ASBR to allocate labels for PEs' routes.

```
Qtech(config)# router bgp 200
Qtech(config router)# neighbor 192.168.1.1 remote as 100
Qtech(config router)# address family ipv4
Qtech(config router af)# neighbor 192.168.1.1 send label
Qtech(config router af)# network 4.4.4.4 mask 255.255.255.255
Qtech(config router af)# end
```

❖ Configuring PE2

Configure Loopback interface address.

```
Qtech(config)# interface loopback 0
Qtech(config if Loopback 0)# ip address 4.4.4.4 255.255.255.255
Qtech(config if Loopback 0)# exit
```

Configure OSPF protocol and establish the public network route.

```
Qtech(config)# router ospf 20
Qtech(config router)# network 4.4.4.4 0.0.0.0 area 0
Qtech(config router)# network 20.20.20.0 0.0.0.255 area 0
Qtech(config router)# exit
```

Configure LDP protocol and enable MPLS globally.

```
Qtech(config)# mpls ip
Qtech(config)# mpls router ldp
Qtech(config mpls router)# ldp router id interface loopback 0 force
Qtech(config mpls router)# exit
```

Configure the public network tunnel between PEs.

```
Qtech(config)# interface gigabitEthernet 1/1
Qtech(config if GigabitEthernet 1/1)# ip address 20.20.20.1 255.255.255.0
Qtech(config if GigabitEthernet 1/1)# mpls ip
Qtech(config if GigabitEthernet 1/1)# label switching
Qtech(config if GigabitEthernet 1/1)# exit
```

Configure the L2VPN address family.

```
Qtech(config)# router bgp 100
Qtech(config router)# neighbor 1.1.1.1 remote as 200
```

```

Qttech(config router)# neighbor 1.1.1.1 update source loopback 0
Qttech(config router)# neighbor 1.1.1.1 ebgp multihop
Qttech(config router)# address family ipv4
Qttech(config router af)# no neighbor 1.1.1.1 activate
Qttech(config router af)# exit
Ruiije(config router)# address family l2vpn vpls
Qttech(config router af)# neighbor 1.1.1.1 activate
Qttech(config router af)# neighbor 1.1.1.1 send community extended
Qttech(config router af)# exit

```

Configure the Vlan interface.

```

Qttech(config)# vlan 10
Qttech(config vlan)# exit

```

Configure the interface that connects PEs and CEs to bind the VPLS instance.

```

Qttech(config)# interface gigabitEthernet 1/2
Qttech(config if GigabitEthernet 1/2)# switchport access vlan 10
Qttech(config if GigabitEthernet 1/2)# exit

```

Configure a VPLS instance.

```

Qttech# configure terminal
Qttech(config)# l2 vfi vpls 1 vpnid 1 autodiscovery
Qttech(config vfi)# rd 200:1
Qttech(config vfi)# signal bgp
Qttech(config vfi)# encapsulation mpls ethernet
Qttech(config vfi)# route target both 10000:1
Qttech(config vfi)# mtu 1500
Qttech(config vfi)# site id 2
Qttech(config vfi site)# xconnect interface vlan 10
Qttech(config vfi site)#exit site mode
Qttech(config vfi)#exit

```

❖ Configuring CE2

See "Configuring CE2" in basic configuration examples.

Displaying verification

After the configuration, CE 1 can ping with CE 2.

After completing the configuration of Kompella VPLS, use the following commands to check the operation of VPLS.

Command	Function
Qttech# show bgp l2vpn vpls all	Display all the VPLS information.
Qttech# show mpls l2transport vc [<i>vc_id</i> [<i>ip-address</i>]] [interface <i>interface_name</i>] [detail]	Display information about PW (including VPWS PW and VPLS PW)

Qtech# show bgp l2vpn { vpls vpws } all connections [neighbor address] [interface interface_name] [site-id id] [detail]	Display VPLS-PW's information.
Qtech# show mpls vfi [name]	Display all the configured or specified VFI information.

2.4.4 Typical Examples of Kompella VPLS Configuration for Routers

2.4.4.1 Basic configuration examples (Ethernet access)

Networking Requirements

- ❖ LAN segments of customer S in Site A and Site B are connected with each other through the carrier's network devices, PE1 and PE2, forming a virtual and simulative LAN service, or VPLS service;
- ❖ PE1 and PE2 are in the same autonomous domain and can automatically detect PE devices that join in the VPLS instance;
- ❖ Customer S's long-term network deployment plan is to connect LANs in five sites at most;
- ❖ The signaling protocol adopted by the carrier is the MP-BGP4 protocol;
- ❖ PEs are connected to CEs through the Ethernet interface.

Topology

Figure 1-45 Basic Kompella VPLS configuration networking topology

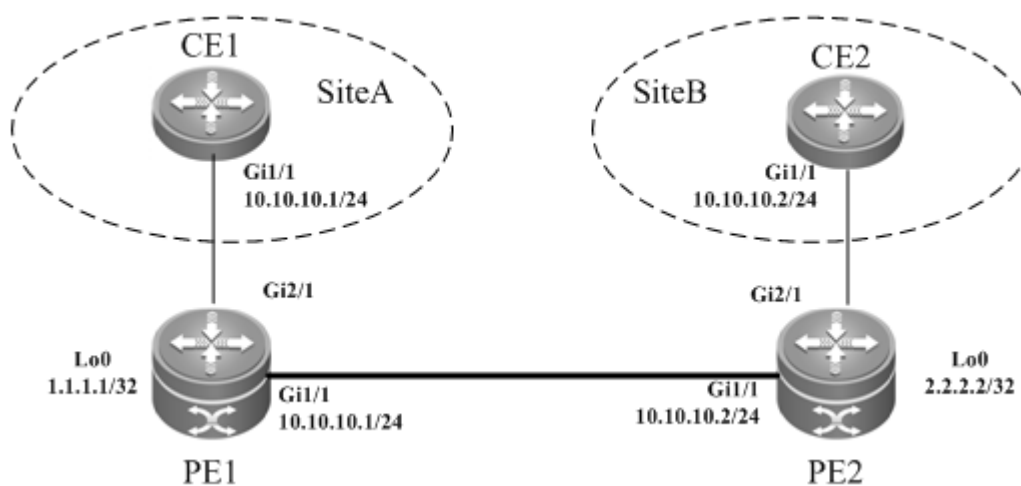

Notes

Before configuring Kompella VPLS, complete the following tasks:

- ❖ Configure the public network tunnel that transmits data frames between VPLS PEs;
- ❖ Enable the L2VPN address family on PEs;

- ❖ Obtain Kompella VPLS configuration information including VPLS instance descriptive information, RT value, VE ID, planned site number, VE ID deviation and interface from the network administrator, and configure the Kompella VPLS instance;
- ❖ Configure the user access VPLS.

Configuration Steps

- ❖ Configuring CE1

Configure OSPF protocol.

```
Qtech# configure terminal
Qtech(config)# router ospf 10
Qtech(config router)# network 10.10.10.0 0.0.0.255 area 0
Qtech(config router)# exit
```

Configure the interface between CEs and PEs.

```
Qtech(config)# interface gigabitEthernet 1/1
Qtech(config if GigabitEthernet 1/1)# ip ref
Qtech(config if GigabitEthernet 1/1)# ip address 10.10.10.1 255.255.255.0
Qtech(config router)# exit
```

- ❖ Configuring PE1

Configure Loopback interface address.

```
Qtech(config)# interface loopback 0
Qtech(config if Loopback 0)# ip address 1.1.1.1 255.255.255.255
Qtech(config if Loopback 0)# exit
```

Configure OSPF protocol and establish the public network route.

```
Qtech(config)# router ospf 10
Qtech(config router)# network 1.1.1.1 0.0.0.0 area 0
Qtech(config router)# network 10.10.10.0 0.0.0.255 area 0
Qtech(config router)# exit
```

Configure LDP protocol and enable MPLS globally.

```
Qtech(config)# mpls ip
Qtech(config)# mpls router ldp
Qtech(config mpls router)# ldp router id interface loopback 0 force
Qtech(config mpls router)# exit
```

Configure the public network tunnel between PEs.

```
Qtech(config)# interface gigabitEthernet 1/1
Qtech(config if GigabitEthernet 1/1)# ip ref
Qtech(config if GigabitEthernet 1/1)# ip address 10.10.10.1 255.255.255.0
Qtech(config if GigabitEthernet 1/1)# mpls ip
```

```
Qtech(config if GigabitEthernet 1/1)# label switching
Qtech(config if GigabitEthernet 1/1)# exit
```

Configure the L2VPN address family.

```
Qtech(config)# router bgp 100
Qtech(config router)# neighbor 2.2.2.2 remote as 100
Qtech(config router)# neighbor 2.2.2.2 update source loopback 0
Ruiije(config router)# address family l2vpn vpls
Qtech(config router af)# neighbor 2.2.2.2 activate
Qtech(config router af)# neighbor 2.2.2.2 send community extended
Qtech(config router af)# exit
```

Configure a VPLS instance.

```
Qtech# configure terminal
Qtech(config)# l2 vfi vpls 1 vpnid 1 autodiscovery
Qtech(config vfi)# rd 1:1
Qtech(config vfi)# signal bgp
Qtech(config vfi)# encapsulation mpls ethernet
Qtech(config vfi)# route target both 10000:1
Qtech(config vfi)# site id 1
Qtech(config vfi site)# xconnect interface gigabitEthernet 2/1
Qtech(config vfi site)#exit site id
Qtech(config vfi)# exit
```

Configure the interface.

```
Qtech(config)# interface gigabitEthernet 2/1
Qtech(config if GigabitEthernet 2/1)# ip ref
Qtech(config if GigabitEthernet 2/1)# exit
```

❖ Configuring PE2

Configure Loopback interface address.

```
Qtech(config)# interface loopback 0
Qtech(config if Loopback 0)# ip address 2.2.2.2 255.255.255.255
Qtech(config if Loopback 0)# exit
```

Configure OSPF protocol and establish the public network route.

```
Qtech(config)# router ospf 10
Qtech(config router)# network 2.2.2.2 0.0.0.0 area 0
Qtech(config router)# network 10.10.10.0 0.0.0.255 area 0
Qtech(config router)# exit
```

Configure LDP protocol and enable MPLS globally.

```
Qtech(config)# mpls ip
```

```
Qttech(config)# mpls router ldp
Qttech(config mpls router)# ldp router id interface loopback 0 force
Qttech(config mpls router)# exit
```

Configure the public network tunnel between PEs.

```
Qttech(config)# interface gigabitEthernet 1/1
Qttech(config if GigabitEthernet 1/1)# ip ref
Qttech(config if GigabitEthernet 1/1)# ip address 10.10.10.2 255.255.255.0
Qttech(config if GigabitEthernet 1/1)# mpls ip
Qttech(config if GigabitEthernet 1/1)# label switching
Qttech(config if GigabitEthernet 1/1)# exit
```

Configure the L2VPN address family.

```
Qttech(config)# router bgp 100
Qttech(config router)# neighbor 1.1.1.1 remote as 100
Qttech(config router)# neighbor 1.1.1.1 update source loopback 0
Ruiije(config router)# address family l2vpn vpls
Qttech(config router af)# neighbor 1.1.1.1 activate
Qttech(config router af)# neighbor 1.1.1.1 send community extended
Qttech(config router af)# exit
```

Configure a VPLS instance.

```
Qttech# configure terminal
Qttech(config)# 12 vfi vpls 1 vpnid 1 autodiscovery
Qttech(config vfi)# rd 2:2
Qttech(config vfi)# signal bgp
Qttech(config vfi)# encapsulation mpls ethernet
Qttech(config vfi)# route target both 10000:1
Qttech(config vfi)# site id 2
Qttech(config vfi site)# xconnect interface gigabitEthernet 2/1
Qttech(config vfi site)#exit site id
Qttech(config vfi)#exit
```

Configure the interface.

```
Qttech(config)# interface gigabitEthernet 2/1
Qttech(config if GigabitEthernet 2/1)# ip ref
Qttech(config if GigabitEthernet 2/1)# exit
```

❖ Configuring CE2

Configure OSPF protocol.

```
Qttech# configure terminal
Qttech(config)# router ospf 10
Qttech(config router)# network 10.10.10.0 0.0.0.255 area 0
Qttech(config router)# exit
```

Configure the interface between CEs and PEs.

```
Qtech(config)# interface gigabitEthernet 1/1
Qtech(config if GigabitEthernet 1/1)# ip ref
Qtech(config if GigabitEthernet 1/1)# ip address 10.10.10.2 255.255.255.0
Qtech(config router)# exit
```

Displaying verification

After the configuration, CE 1 can ping with CE 2.

After completing the configuration of Kompella VPLS, use the following commands to check the operation of VPLS.

Command	Function
Qtech# show bgp l2vpn vpls all	Display all the VPLS information.
Qtech# show mpls l2transport vc [<i>vc_id</i> [<i>ip-address</i>]] [interface <i>interface_name</i>] [detail]	Display information about PW (including VPWS PW and VPLS PW)
Qtech# show bgp l2vpn { vpls vpws } all connections [neighbor <i>address</i>] [interface <i>interface_name</i>] [site-id <i>id</i>] [detail]	Display VPLS-PW's information.
Qtech# show mpls vfi [<i>name</i>]	Display all the configured or specified VFI information.

2.4.4.2 Basic configuration examples (Ethernet sub-interface access)

Networking Requirements

- ❖ LAN segments of customer S in Site A and Site B are connected with each other through the carrier's network devices, PE1 and PE2, forming a virtual and simulative LAN service, or VPLS service;
- ❖ PE1 and PE2 are in the same autonomous domain and can automatically detect PE devices that join in the VPLS instance;
- ❖ Customer S's long-term network deployment plan is to connect LANs in five sites at most;
- ❖ The signaling protocol adopted by the carrier is the MP-BGP4 protocol;
- ❖ PEs are connected to CEs through the Ethernet sub-interface.

Topology

Figure 1-46 Basic Kompella VPLS configuration networking topology

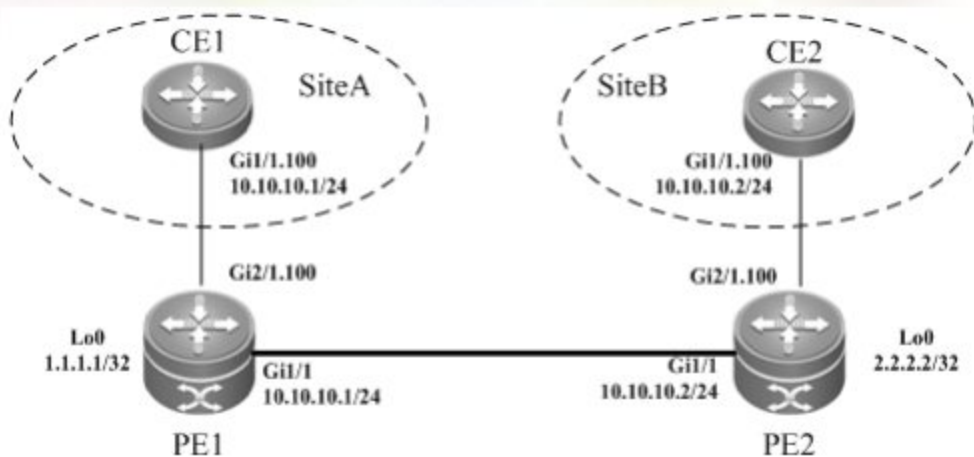

Notes

Before configuring Kompella VPLS, complete the following tasks:

- ❖ Configure the public network tunnel that transmits data frames between VPLS PEs;
- ❖ Enable the L2VPN address family on PEs;
- ❖ Obtain Kompella VPLS configuration information including VPLS instance descriptive information, RT value, VE ID, planned site number, VE ID deviation and interface from the network administrator, and configure the Kompella VPLS instance;
- ❖ Configure the user access VPLS.

Configuration Steps

- ❖ Configuring CE1

Configure OSPF protocol.

```
Qtech# configure terminal
Qtech(config)# router ospf 10
Qtech(config-router)# network 10.10.10.0 0.0.0.255 area 0
Qtech(config-router)# exit
```

Configure the interface between CEs and PEs.

```
Qtech(config)# interface gigabitEthernet 1/1
Qtech(config-if-GigabitEthernet 1/1)# ip ref
Qtech(config-if-GigabitEthernet 1/1)# exit
Qtech(config)# interface gigabitEthernet 1/1.100
Qtech(config-if-GigabitEthernet 1/1.100)# encapsulation dot1Q 100
Qtech(config-if-GigabitEthernet 1/1.100)# ip address 10.10.10.1 255.255.255.0
Qtech(config-router)# exit
```

- ❖ Configuring PE1

Configure Loopback interface address.

```
Qtech(config)# interface loopback 0
Qtech(config if Loopback 0)# ip address 1.1.1.1 255.255.255.255
Qtech(config if Loopback 0)# exit
```

Configure OSPF protocol and establish the public network route.

```
Qtech(config)# router ospf 10
Qtech(config router)# network 1.1.1.1 0.0.0.0 area 0
Qtech(config router)# network 10.10.10.0 0.0.0.255 area 0
Qtech(config router)# exit
```

Configure LDP protocol and enable MPLS globally.

```
Qtech(config)# mpls ip
Qtech(config)# mpls router ldp
Qtech(config mpls router)# ldp router id interface loopback 0 force
Qtech(config mpls router)# exit
```

Configure the public network tunnel between PEs.

```
Qtech(config)# interface gigabitEthernet 1/1
Qtech(config if GigabitEthernet 1/1)# ip ref
Qtech(config if GigabitEthernet 1/1)# ip address 10.10.10.1 255.255.255.0
Qtech(config if GigabitEthernet 1/1)# mpls ip
Qtech(config if GigabitEthernet 1/1)# label switching
Qtech(config if GigabitEthernet 1/1)# exit
```

Configure the L2VPN address family.

```
Qtech(config)# router bgp 100
Qtech(config router)# neighbor 2.2.2.2 remote as 100
Qtech(config router)# neighbor 2.2.2.2 update source loopback 0
Ruiije(config router)# address family l2vpn vpls
Qtech(config router af)# neighbor 2.2.2.2 activate
Qtech(config router af)# neighbor 2.2.2.2 send community extended
Qtech(config router af)# exit
```

Configure the interface.

```
Qtech(config)# interface gigabitEthernet 2/1
Qtech(config if GigabitEthernet 2/1)# ip ref
Qtech(config if GigabitEthernet 2/1)# exit
Qtech(config)# interface gigabitEthernet 2/1.100
Qtech(config if GigabitEthernet 2/1.100)# encapsulation dot1Q 100
Qtech(config if GigabitEthernet 2/1.100)# exit
```

Configure a VPLS instance.

```
Qtech# configure terminal
Qtech(config)# l2 vfi vpls 1 vpnid 1 autodiscovery
```

```
Qtech(config vfi)# rd 1:1
Qtech(config vfi)# signal bgp
Qtech(config vfi)# encapsulation mpls ethernetvlan
Qtech(config vfi)# route target both 10000:1
Qtech(config vfi)# site id 1
Qtech(config vfi site)# xconnect interface gigabitEthernet 2/1.100
Qtech(config vfi site)#exit site mode
Qtech(config vfi)#exit
```

❖ Configuring PE2

Configure Loopback interface address.

```
Qtech(config)# interface loopback 0
Qtech(config if Loopback 0)# ip address 2.2.2.2 255.255.255.255
Qtech(config if Loopback 0)# exit
```

Configure OSPF protocol and establish the public network route.

```
Qtech(config)# router ospf 10
Qtech(config router)# network 2.2.2.2 0.0.0.0 area 0
Qtech(config router)# network 10.10.10.0 0.0.0.255 area 0
Qtech(config router)# exit
```

Configure LDP protocol and enable MPLS globally.

```
Qtech(config)# mpls ip
Qtech(config)# mpls router ldp
Qtech(config mpls router)# ldp router id interface loopback 0 force
Qtech(config mpls router)# exit
```

Configure the public network tunnel between PEs.

```
Qtech(config)# interface gigabitEthernet 1/1
Qtech(config if GigabitEthernet 1/1)# ip ref
Qtech(config if GigabitEthernet 1/1)# ip address 10.10.10.2 255.255.255.0
Qtech(config if GigabitEthernet 1/1)# mpls ip
Qtech(config if GigabitEthernet 1/1)# label switching
Qtech(config if GigabitEthernet 1/1)# exit
```

Configure the L2VPN address family.

```
Qtech(config)# router bgp 100
Qtech(config router)# neighbor 1.1.1.1 remote as 100
Qtech(config router)# neighbor 1.1.1.1 update source loopback 0
Ruiije(config router)# address family l2vpn vpls
Qtech(config router af)# neighbor 1.1.1.1 activate
Qtech(config router af)# neighbor 1.1.1.1 send community extended
Qtech(config router af)# exit
```

Bind the interface to the VPLS instance.

```

Qttech(config)# interface gigabitEthernet 2/1
Qttech(config if GigabitEthernet 2/1)# ip ref
Qttech(config if GigabitEthernet 2/1)# exit
Qttech(config)# interface gigabitEthernet 2/1.100
Qttech(config if GigabitEthernet 2/1.100)# encapsulation dot1Q 100
Qttech(config if GigabitEthernet 2/1.100)# exit

```

Configure a VPLS instance.

```

Qttech# configure terminal
Qttech(config)# l2 vfi vpls 1 vpnid 1 autodiscovery
Qttech(config vfi)# rd 2:2
Qttech(config vfi)# signal bgp
Qttech(config vfi)# encapsulation mpls ethernetvlan
Qttech(config vfi)# route target both 10000:1
Qttech(config vfi)# site id 2
Qttech(config vfi site)# xconnect interface gigabitEthernet 2/1.100
Qttech(config vfi site)#exit site mode
Qttech(config vfi)#exit

```

❖ Configuring CE2

Configure OSPF protocol.

```

Qttech# configure terminal
Qttech(config)# router ospf 10
Qttech(config router)# network 10.10.10.0 0.0.0.255 area 0
Qttech(config router)# exit

```

Configure the interface between CEs and PEs.

```

Qttech(config)# interface gigabitEthernet 1/1.100
Qttech(config if GigabitEthernet 1/1.100)# encapsulation dot1Q 100
Qttech(config if GigabitEthernet 1/1.100)# ip ref
Qttech(config if GigabitEthernet 1/1.100)# ip address 10.10.10.2 255.255.255.0
Qttech(config router)# exit

```

Displaying verification

After the configuration, CE 1 can ping with CE 2.

After completing the configuration of Kompella VPLS, use the following commands to check the operation of VPLS.

Command	Function
Qttech# show bgp l2vpn vpls all	Display all the VPLS information.
Qttech# show mpls l2transport vc [vc_id [ip-address]] [interface interface_name] [detail]	Display information about PW (including VPWS PW and VPLS PW)

Qtech# show bgp l2vpn { vpls vpws } all connections [neighbor address] [interface interface_name] [site-id id] [detail]	Display VPLS-PW's information.
Qtech# show mpls vfi [name]	Display all the configured or specified VFI information.

2.4.4.3 Inter-AS configuration examples – Option A solution

Networking Requirements

- ❖ LAN segments of customer S in Site A and Site B are connected with each other through the carrier's PE1 in AS100 and PE2 in AS 200, forming a virtual and simulative LAN service, or VPLS service;
- ❖ PE1 and PE2 are in different autonomous domains. ASBR 1 and ASBR 2 are considered CE devices by each other, which means the interface between ASBRs connects AC to VPLS instance;

Topology

Figure 1-47 Kompella VPLS Inter-AS networking topology

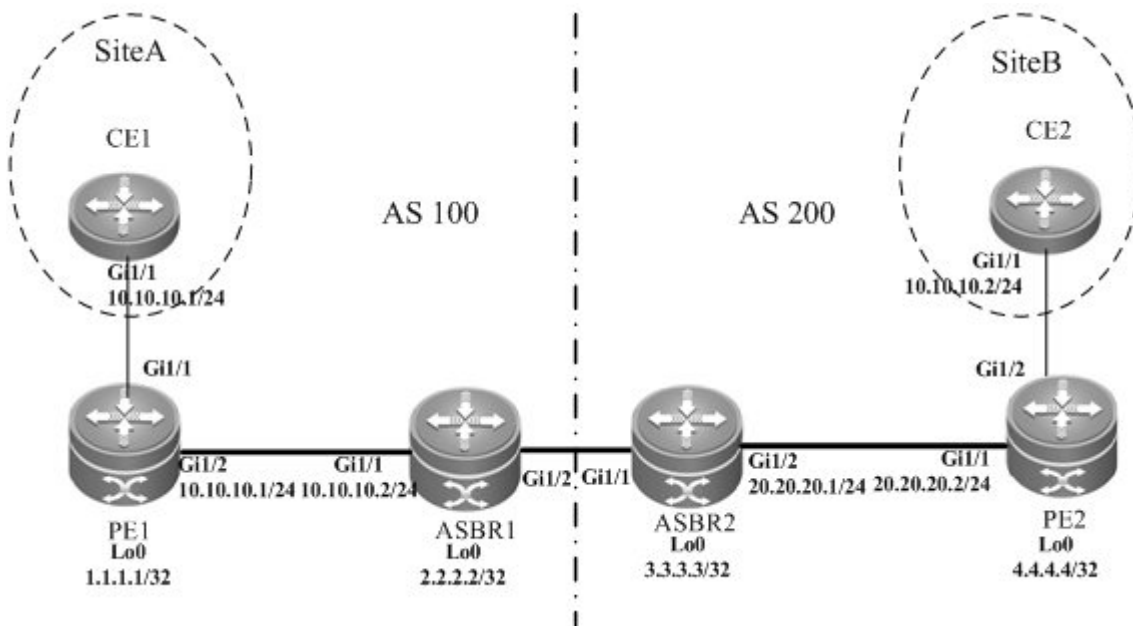

The above figure shows the structure of the Kompella VPLS Inter-AS networking topology in Option A. The intermediate interface is considered by ASBRs as AC connection.

Notes

Before configuring Kompella VPLS, complete the following tasks:

- ❖ Run IGP in the carrier's network to realize connection between PE and ASBR devices;
- ❖ Establish MP-IBGP peer relationship between PEs and ASBRs in the domain;

- ❖ Obtain Kompella VPLS configuration information including VPLS instance descriptive information, RT value, VE ID, maximum planned site number, VE ID deviation and interface from the network administrator.

Configuration Steps

- ❖ Configuring CE1

See "Configuring CE1" in basic configuration examples.

- ❖ Configuring PE1

Configure Loopback interface address.

```
Qtech(config)# interface loopback 0
Qtech(config if Loopback 0)# ip address 1.1.1.1 255.255.255.255
Qtech(config if Loopback 0)# exit
```

Configure OSPF protocol, establish the public network route so that PEs can ping with ASBRs in the same domain.

```
Qtech(config)# router ospf 10
Qtech(config router)# network 1.1.1.1 0.0.0.0 area 0
Qtech(config router)# network 10.10.10.0 0.0.0.255 area 0
Qtech(config router)# exit
```

Configure LDP protocol and enable MPLS globally.

```
Qtech(config)# mpls ip
Qtech(config)# mpls router ldp
Qtech(config mpls router)# ldp router id interface loopback 0 force
Qtech(config mpls router)# exit
```

Configure the public network tunnel between PEs.

```
Qtech(config)# interface gigabitEthernet 1/2
Qtech(config if GigabitEthernet 1/2)# ip ref
Qtech(config if GigabitEthernet 1/2)# ip address 10.10.10.1 255.255.255.0
Qtech(config if GigabitEthernet 1/2)# mpls ip
Qtech(config if GigabitEthernet 1/2)# label switching
Qtech(config if GigabitEthernet 1/2)# exit
```

Configure the L2VPN address family.

```
Qtech(config)# router bgp 100
Qtech(config router)# neighbor 2.2.2.2 remote as 100
Qtech(config router)# neighbor 2.2.2.2 update source loopback 0
Ruiije(config router)# address family l2vpn vpls
Qtech(config router af)# neighbor 2.2.2.2 activate
Qtech(config router af)# neighbor 2.2.2.2 send community extended
Qtech(config router af)# exit
```

Configure the CE-PE interface.

```
Qtech(config)# interface gigabitEthernet 1/1
Qtech(config if GigabitEthernet 1/1)# ip ref
Qtech(config if GigabitEthernet 1/1)# exit
```

Configure a VPLS instance.

```
Qtech# configure terminal
Qtech(config)# 12 vfi vpls 1 vpnid 1 autodiscovery
Qtech(config vfi)# rd 100:1
Qtech(config vfi)# signal bgp
Qtech(config vfi)# encapsulation mpls ethernet
Qtech(config vfi)# route target both 10000:1
Qtech(config vfi)# site id 1
Qtech(config vfi site)# xconnect interface gigabitEthernet 1/1
Qtech(config vfi site)#exit site mode
```

❖ Configuring ASBR 1

Configure Loopback interface address.

```
Qtech(config)# interface loopback 0
Qtech(config if Loopback 0)# ip address 2.2.2.2 255.255.255.255
Qtech(config if Loopback 0)# exit
```

Configure OSPF protocol, establish the public network route so that PEs can ping with ASBRs in the same domain.

```
Qtech(config)# router ospf 10
Qtech(config router)# network 2.2.2.2 0.0.0.0 area 0
Qtech(config router)# network 10.10.10.0 0.0.0.255 area 0
Qtech(config router)# exit
```

Configure LDP protocol and enable MPLS globally.

```
Qtech(config)# mpls ip
Qtech(config)# mpls router ldp
Qtech(config mpls router)# ldp router id interface loopback 0 force
Qtech(config mpls router)# exit
```

Configure the public network tunnel between PEs.

```
Qtech(config)# interface gigabitEthernet 1/1
Qtech(config if GigabitEthernet 1/1)# ip ref
Qtech(config if GigabitEthernet 1/1)# ip address 10.10.10.2 255.255.255.0
Qtech(config if GigabitEthernet 1/1)# mpls ip
Qtech(config if GigabitEthernet 1/1)# label switching
Qtech(config if GigabitEthernet 1/1)# exit
```

Configure the L2VPN address family.

```
Qtech(config)# router bgp 100
Qtech(config router)# neighbor 1.1.1.1 remote as 100
Qtech(config router)# neighbor 1.1.1.1 update source loopback 0
Ruijie(config router)# address family l2vpn vpls
Qtech(config router af)# neighbor 1.1.1.1 activate
Qtech(config router af)# neighbor 1.1.1.1 send community extended
Qtech(config router af)# exit
```

Configure the interface that connects ASBR 1 and ASBR 2.

```
Qtech(config)# interface gigabitEthernet 1/2
Qtech(config if GigabitEthernet 1/2)# ip ref
Qtech(config if GigabitEthernet 1/2)# exit
```

Configure a VPLS instance.

```
Qtech# configure terminal
Qtech(config)# 12 vfi vpls 1 vpnid 1 autodiscovery
Qtech(config vfi)# rd 100:1
Qtech(config vfi)# signal bgp
Qtech(config vfi)# encapsulation mpls ethernet
Qtech(config vfi)# route target both 10000:1
Qtech(config vfi)# mtu 1500
Qtech(config vfi)# site id 2
Qtech(config vfi site)# xconnect interface gigabitEthernet 1/2
Qtech(config vfi site)#exit site mode
Qtech(config vfi)#exit
```

❖ Configuring ASBR 2

Configure Loopback interface address.

```
Qtech(config)# interface loopback 0
Qtech(config if Loopback 0)# ip address 3.3.3.3 255.255.255.255
Qtech(config if Loopback 0)# exit
```

Configure OSPF protocol, establish the public network route so that PEs can ping with ASBRs in the same domain.

```
Qtech(config)# router ospf 10
Qtech(config router)# network 3.3.3.3 0.0.0.0 area 0
Qtech(config router)# network 20.20.20.0 0.0.0.255 area 0
Qtech(config router)# exit
```

Configure LDP protocol and enable MPLS globally.

```
Qtech(config)# mpls ip
Qtech(config)# mpls router ldp
Qtech(config mpls router)# ldp router id interface loopback 0 force
```

```
Qttech(config mpls router)# exit
```

Configure the public network tunnel between PEs.

```
Qttech(config)# interface gigabitEthernet 1/2
Qttech(config if GigabitEthernet 1/2)# ip ref
Qttech(config if GigabitEthernet 1/2)# ip address 20.20.20.2 255.255.255.0
Qttech(config if GigabitEthernet 1/2)# mpls ip
Qttech(config if GigabitEthernet 1/2)# label switching
Qttech(config if GigabitEthernet 1/2)# exit
```

Configure the L2VPN address family.

```
Qttech(config)# router bgp 200
Qttech(config router)# neighbor 4.4.4.4 remote as 200
Qttech(config router)# neighbor 4.4.4.4 update source loopback 0
Ruiije(config router)# address family l2vpn vpls
Qttech(config router af)# neighbor 4.4.4.4 activate
Qttech(config router af)# neighbor 4.4.4.4 send community extended
Qttech(config router af)# exit
```

Configure the interface that connects ASBR 1 and ASBR 2.

```
Qttech(config)# interface gigabitEthernet 1/1
Qttech(config if GigabitEthernet 1/1)# ip ref
Qttech(config if GigabitEthernet 1/1)# exit
```

Configure a VPLS instance.

```
Qttech# configure terminal
Qttech(config)# l2 vfi vpls 1 vpnid 1 autodiscovery
Qttech(config vfi)# rd 200:1
Qttech(config vfi)# signal bgp
Qttech(config vfi)# encapsulation mpls ethernet
Qttech(config vfi)# route target both 10000:1
Qttech(config vfi)# site id 3
Qttech(config vfi site)# xconnect interface gigabitEthernet 1/1
Qttech(config vfi site)#exit site mode
Qttech(config vfi)#exit
```

❖ Configuring PE2

Configure Loopback interface address.

```
Qttech(config)# interface loopback 0
Qttech(config if Loopback 0)# ip address 4.4.4.4 255.255.255.255
Qttech(config if Loopback 0)# exit
```

Configure OSPF protocol, establish the public network route so that PEs can ping with ASBRs in the same domain.

```
Qttech(config)# router ospf 10
Qttech(config router)# network 4.4.4.4 0.0.0.0 area 0
Qttech(config router)# network 20.20.20.0 0.0.0.255 area 0
Qttech(config router)# exit
```

Configure LDP protocol and enable MPLS globally.

```
Qttech(config)# mpls ip
Qttech(config)# mpls router ldp
Qttech(config mpls router)# ldp router id interface loopback 0 force
Qttech(config mpls router)# exit
```

Configure the public network tunnel between PEs.

```
Qttech(config)# interface gigabitEthernet 1/1
Qttech(config if GigabitEthernet 1/1)# ip ref
Qttech(config if GigabitEthernet 1/1)# ip address 20.20.20.1 255.255.255.0
Qttech(config if GigabitEthernet 1/1)# mpls ip
Qttech(config if GigabitEthernet 1/1)# label switching
Qttech(config if GigabitEthernet 1/1)# exit
```

Configure the L2VPN address family.

```
Qttech(config)# router bgp 200
Qttech(config router)# neighbor 3.3.3.3 remote as 200
Qttech(config router)# neighbor 3.3.3.3 update source loopback 0
Ruiije(config router)# address family l2vpn vpls
Qttech(config router af)# neighbor 3.3.3.3 activate
Qttech(config router af)# neighbor 3.3.3.3 send community extended
Qttech(config router af)# exit
```

Configure the interface that connects PE 2 and CE.

```
Qttech(config)# interface gigabitEthernet 1/2
Qttech(config if GigabitEthernet 1/2)# ip ref
Qttech(config if GigabitEthernet 1/2)# exit
```

Configure a VPLS instance.

```
Qttech# configure terminal
Qttech(config)# l2 vfi vpls 1 vpnid 1 autodiscovery
Qttech(config vfi)# rd 200:1
Qttech(config vfi)# signal bgp
Qttech(config vfi)# encapsulation mpls ethernet
Qttech(config vfi)# route target both 10000:1
Qttech(config vfi)# site id 4
Qttech(config vfi site)# xconnect interface gigabitEthernet 1/2
```

```
Qtech(config vfi site)#exit site mode
Qtech(config vfi)#exit
```

❖ Configuring CE2

See "Configuring CE2" in basic configuration examples.

Displaying verification

After the configuration, CE 1 can ping with CE 2.

After completing the configuration of Kompella VPLS, use the following commands to check the operation of VPLS.

Command	Function
Qtech# show bgp l2vpn vpls all	Display all the VPLS information.
Qtech# show mpls l2transport vc [<i>vc_id</i> [<i>ip-address</i>]] [interface <i>interface_name</i>] [detail]	Display information about PW (including VPWS PW and VPLS PW)
Qtech# show bgp l2vpn { vpls vpws } all connections [neighbor <i>address</i>] [interface <i>interface_name</i>] [site-id <i>id</i>] [detail]	Display VPLS-PW's information.
Qtech# show mpls vfi [<i>name</i>]	Display all the configured or specified VFI information.

Inter-AS Configuration Examples – Option C Solution

Networking Requirements

- ❖ LAN segments of customer S in Site A and Site B are connected with each other through the carrier's PE1 in AS 1 and PE2 in AS 2, forming a virtual and simulative LAN service, or VPLS service;
- ❖ PE1 and PE2 are in different autonomous domains and can automatically detect PE devices that join in the VPLS instance;
- ❖ ASBR is not responsible for maintaining VPLS label block messages;
- ❖ VPLS label block messages are directly switched between PEs.

Topology

Figure 1-48 Kompella VPLS Option C Inter-AS networking topology

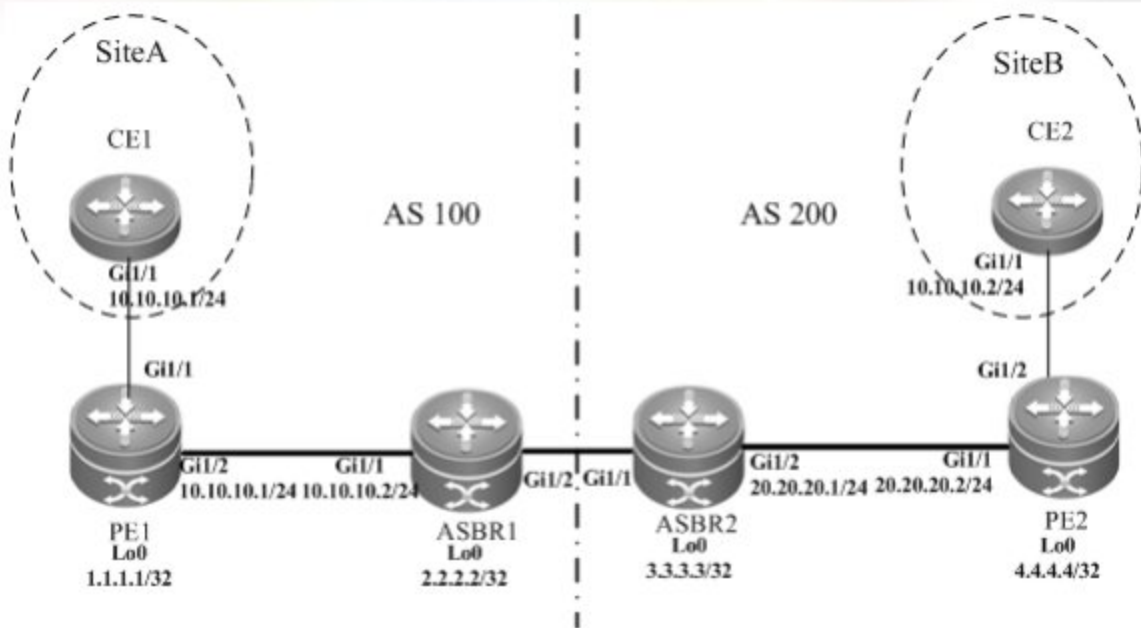

The above figure shows the structure of Kompella VPLS Option C Inter-AS networking topology. Customer S's LAN segments in Site A and Site B are connected to each other through PE1 in AS100 and PE2 in AS200 as one LAN.

Notes

Before configuring Kompella VPLS, complete the following tasks:

- ❖ Run IGP in the carrier's network to realize connection between VPLS-PE and ASBR devices in the same AS;
- ❖ Establish a public network tunnel between PE and ASBR devices in the same domain and enable MPLS on the ASBR interface;
- ❖ Establish IBGP between PE and ASBR in the same domain;
- ❖ Establish EBGP between ASBR devices and enable send-label;
- ❖ Obtain Kompella VPLS configuration information including VPLS instance descriptive information, RT value, VE ID, planned site number, VE ID deviation and interface from the network administrator.



Caution

When Option C (Multihop MP-EBGP) is applied to realize Inter-AC Kompella L2VPN applications, if the MP-EBGP connection is set up by the route reflector between autonomous domains to switch NLRI information of L2VPN, the next hop will be changed into itself by default when such information is sent to the peer EBGP. To realize the Kompella L2VPN through Option C solution, the **neighbor next-hop-unchanged** command must be configured on the route reflector so that the reflector will not change the next hop when NLRI information is sent. Otherwise, the Inter-AS forwarding will fail.

Configuration Steps

❖ Configuring CE1

See "Configuring CE1" in basic configuration examples.

❖ Configuring PE1

Configure Loopback interface address.

```
Qtech(config)# interface loopback 0
Qtech(config if Loopback 0)# ip address 1.1.1.1 255.255.255.255
Qtech(config if Loopback 0)# exit
```

Configure OSPF protocol and establish the public network route.

```
Qtech(config)# router ospf 10
Qtech(config router)# network 1.1.1.1 0.0.0.0 area 0
Qtech(config router)# network 10.10.10.0 0.0.0.255 area 0
Qtech(config router)# exit
Qtech(config router)# exit
```

Configure LDP protocol and enable MPLS globally.

```
Qtech(config)# mpls ip
Qtech(config)# mpls router ldp
Qtech(config mpls router)# ldp router id interface loopback 0 force
Qtech(config mpls router)# exit
```

Configure the public network tunnel between PEs.

```
Qtech(config)# interface gigabitEthernet 1/2
Qtech(config if GigabitEthernet 1/2)# ip ref
Qtech(config if GigabitEthernet 1/2)# ip address 10.10.10.1 255.255.255.0
Qtech(config if GigabitEthernet 1/2)# mpls ip
Qtech(config if GigabitEthernet 1/2)# label switching
Qtech(config if GigabitEthernet 1/2)# exit
```

Configure the L2VPN address family.

```
Qtech(config)# router bgp 100
Qtech(config router)# neighbor 4.4.4.4 remote as 200
Qtech(config router)# neighbor 4.4.4.4 update source loopback 0
Qtech(config router)# neighbor 4.4.4.4 ebgp multihop
Qtech(config router)# address family ipv4
Qtech(config router af)# no neighbor 4.4.4.4 activate
Qtech(config router af)# exit
Ruiije(config router)# address family l2vpn vpls
Qtech(config router af)# neighbor 4.4.4.4 activate
Qtech(config router af)# neighbor 4.4.4.4 send community extended
Qtech(config router af)# exit
```

Configure the interface that connects CEs.

```
Qtech(config)# interface gigabitEthernet 1/1
Qtech(config if GigabitEthernet 1/1)# ip ref
Qtech(config if GigabitEthernet 1/1)# exit
```

Configure a VPLS instance.

```
Qtech# configure terminal
Qtech(config)# 12 vfi vpls 1 vpnid 1 autodiscovery
Qtech(config vfi)# rd 100:1
Qtech(config vfi)# signal bgp
Qtech(config vfi)# encapsulation mpls ethernet
Qtech(config vfi)# route target both 10000:1
Qtech(config vfi)# site id 1
Qtech(config vfi site)# xconnect interface gigabitEthernet 1/1
Qtech(config vfi site)#exit site mode
Qtech(config vfi)#exit
```

❖ Configuring ASBR 1

Configure Loopback interface address.

```
Qtech(config)# interface loopback 0
Qtech(config if Loopback 0)# ip address 2.2.2.2 255.255.255.255
Qtech(config if Loopback 0)# exit
```

Configure OSPF protocol and establish the public network route.

```
Qtech(config)# router ospf 10
Qtech(config router)# redistribute bgp subnets
Qtech(config router)# network 2.2.2.2 0.0.0.0 area 0
Qtech(config router)# network 10.10.10.0 0.0.0.255 area 0
Qtech(config router)# exit
```

Configure LDP protocol and enable MPLS globally.

```
Qtech(config)# mpls ip
Qtech(config)# mpls router ldp
Qtech(config mpls router)# ldp router id interface loopback 0 force
Qtech(config mpls router)# advertise labels for bgp routes
Qtech(config mpls router)# exit
```

#Configure the public network tunnel between PEs.

```
Qtech(config)# interface gigabitEthernet 1/1
Qtech(config if GigabitEthernet 1/1)# ip ref
Qtech(config if GigabitEthernet 1/1)# ip address 10.10.10.2 255.255.255.0
Qtech(config if GigabitEthernet 1/1)# mpls ip
Qtech(config if GigabitEthernet 1/1)# label switching
```

```
Qtech(config if GigabitEthernet 1/1)# exit
```

Configure the interface that connects ASBRs.

```
Qtech(config)# interface gigabitEthernet 1/2
Qtech(config if GigabitEthernet 1/2)# ip ref
Qtech(config if GigabitEthernet 1/2)# ip address 192.168.1.1 255.255.255.252
Qtech(config if GigabitEthernet 1/2)# label switching
Qtech(config if GigabitEthernet 1/2)# exit
```

Configure ASBR to allocate labels for PEs' routes.

```
Qtech(config)# router bgp 100
Qtech(config router)# neighbor 192.168.1.2 remote as 200
Qtech(config router)# address family ipv4
Qtech(config router af)# neighbor 192.168.1.2 send label
Qtech(config router af)# network 1.1.1.1 mask 255.255.255.255
Qtech(config router af)# end
```

❖ Configuring ASBR 2

Configure Loopback interface address.

```
Qtech(config)# interface loopback 0
Qtech(config if Loopback 0)# ip address 3.3.3.3 255.255.255.255
Qtech(config if Loopback 0)# exit
```

Configure OSPF protocol and establish the public network route.

```
Qtech(config)# router ospf 20
Qtech(config router)# redistribute bgp subnets
Qtech(config router)# network 3.3.3.3 0.0.0.0 area 0
Qtech(config router)# network 20.20.20.0 0.0.0.255 area 0
Qtech(config router)# exit
```

Configure LDP protocol and enable MPLS globally.

```
Qtech(config)# mpls ip
Qtech(config)# mpls router ldp
Qtech(config mpls router)# ldp router id interface loopback 0 force
Qtech(config mpls router)# advertise labels for bgp routes
Qtech(config mpls router)# exit
```

Configure the public network tunnel between PEs.

```
Qtech(config)# interface gigabitEthernet 1/2
Qtech(config if GigabitEthernet 1/2)# ip ref
Qtech(config if GigabitEthernet 1/2)# ip address 20.20.20.2 255.255.255.0
Qtech(config if GigabitEthernet 1/2)# mpls ip
Qtech(config if GigabitEthernet 1/2)# label switching
Qtech(config if GigabitEthernet 1/2)# exit
```

Configure the interface that connects ASBRs.

```
Qtech(config)# interface gigabitEthernet 1/1
Qtech(config if GigabitEthernet 1/1)# ip ref
Qtech(config if GigabitEthernet 1/1)# ip address 192.168.1.1 255.255.255.252
Qtech(config if GigabitEthernet 1/1)# label switching
Qtech(config if GigabitEthernet 1/1)# exit
```

Configure ASBR to allocate labels for PEs' routes.

```
Qtech(config)# router bgp 200
Qtech(config router)# neighbor 192.168.1.1 remote as 100
Qtech(config router)# address family ipv4
Qtech(config router af)# neighbor 192.168.1.1 send label
Qtech(config router af)# network 4.4.4.4 mask 255.255.255.255
Qtech(config router af)# end
```

❖ Configuring PE2

Configure Loopback interface address.

```
Qtech(config)# interface loopback 0
Qtech(config if Loopback 0)# ip address 4.4.4.4 255.255.255.255
Qtech(config if Loopback 0)# exit
```

Configure OSPF protocol and establish the public network route.

```
Qtech(config)# router ospf 20
Qtech(config router)# network 4.4.4.4 0.0.0.0 area 0
Qtech(config router)# network 20.20.20.0 0.0.0.255 area 0
Qtech(config router)# exit
```

Configure LDP protocol and enable MPLS globally.

```
Qtech(config)# mpls ip
Qtech(config)# mpls router ldp
Qtech(config mpls router)# ldp router id interface loopback 0 force
Qtech(config mpls router)# exit
```

Configure the public network tunnel between PEs.

```
Qtech(config)# interface gigabitEthernet 1/1
Qtech(config if GigabitEthernet 1/1)# ip ref
Qtech(config if GigabitEthernet 1/1)# ip address 20.20.20.1 255.255.255.0
Qtech(config if GigabitEthernet 1/1)# mpls ip
Qtech(config if GigabitEthernet 1/1)# label switching
Qtech(config if GigabitEthernet 1/1)# exit
```

Configure the L2VPN address family.

```
Qtech(config)# router bgp 100
Qtech(config router)# neighbor 1.1.1.1 remote as 200
```

```

Qtech(config router)# neighbor 1.1.1.1 update source loopback 0
Qtech(config router)# neighbor 1.1.1.1 ebgp multihop
Qtech(config router)# address family ipv4
Qtech(config router af)# no neighbor 1.1.1.1 activate
Qtech(config router af)# exit
Ruiije(config router)# address family l2vpn vpls
Qtech(config router af)# neighbor 1.1.1.1 activate
Qtech(config router af)# neighbor 1.1.1.1 send community extended
Qtech(config router af)# exit

```

Configure the interface that connects PEs and CEs to bind the VPLS instance.

```

Qtech(config)# interface gigabitEthernet 1/2
Qtech(config if GigabitEthernet 1/2)# ip ref
Qtech(config if GigabitEthernet 1/2)# exit

```

Configure a VPLS instance.

```

Qtech# configure terminal
Qtech(config)# l2 vfi vpls 1 vpnid 1 autodiscovery
Qtech(config vfi)# rd 200:1
Qtech(config vfi)# signal bgp
Qtech(config vfi)# encapsulation mpls ethernet
Qtech(config vfi)# route target both 10000:1
Qtech(config vfi)# mtu 1500
Qtech(config vfi)# site id 2
Qtech(config vfi site)# xconnect interface gigabitEthernet 1/2
Qtech(config vfi site)#exit site mode
Qtech(config vfi)#exit

```

❖ Configuring CE2

See "Configuring CE2" in basic configuration examples.

Displaying verification

After the configuration, CE 1 can ping with CE 2.

After completing the configuration of Kompella VPLS, use the following commands to check the operation of VPLS.

Command	Function
Qtech# show bgp l2vpn vpls all	Display all the VPLS information.
Qtech# show mpls l2transport vc [<i>vc_id</i> [<i>ip-address</i>]] [interface <i>interface_name</i>] [detail]	Display information about PW (including VPWS PW and VPLS PW)
Qtech# show bgp l2vpn { vpls vpws } all connections [neighbor <i>address</i>] [interface <i>interface_name</i>] [site-id <i>id</i>] [detail]	Display VPLS-PW's information.

Qtech# **show mpls vfi** [*name*]

Display all the configured or specified VFI information.



QTECH
МИР ДОСТУПНЕЕ

| www.qtech.ru

3. CONFIGURING BGP/MPLS L3 VPN

3.1 Overview

In traditional VPNs, private network data streams are generally transmitted over public networks through GRE, L2TP, and PPTN tunnel protocols. As another implementation of VPN, BGP/MPLS IP VPN can be considered as a VPN between Layer 2 and Layer 3. An LSP is a tunnel on the public network that is set up through the MPLS LDP. In an MPLS VPN, the different branches of private networks at different locations are connected together to form one network through LSPs. The MPLS VPN also supports interworking between different VPNs. The implementation of VPN through MPLS has natural edges. For VPN users, the work amount is largely reduced since no special VPN devices are required to construct the VPN. Instead, the VPN users can directly use traditional routers. For carriers, the MPLS VPN can be easily expanded.

As a highly effective technical platform for IP backbone networks, MPLS provides VPNs with flexible and scalable technical foundations.

The L3VPN based on BGP/MPLS VPN has the following features:

- ❖ The VPN tunnels are set up on the provider edge (PE) devices of network service providers rather than the customer edge (CE) devices. The VPN routes are also transmitted between PEs. In this manner, users are not required to maintain VPN information.
- ❖ Directly utilize existing routing protocols. The setup of VPN tunnels and route advertising are dynamically implemented, facilitating the expansion of VPNs.
- ❖ Support address overlapping. Different VPN users can use the same address space.
- ❖ On the network of service providers, VPN services are exchanged according to labels rather than traditional routes.
- ❖ Support the same security as user dedicated lines.

The BGP/MPLS VPN provides the following functions:

- ❖ Adopt the LDP to set up LSPs on the backbone network. This process is generally performed on the provider's network and completed when the topology becomes stable.
- ❖ Forward data packets based on the pushed label and the local mapping table.
- ❖ Support MP-BGP and extended BGP attributes to transmit VPN routes and carry VPN attributes and labels.
- ❖ Manage VPN routes to set up multiple routing tables and maintain VPN routes.

3.1.1 Components of a BGP/MPLS VPN

A BGP/MPLS VPN model consists of three components, as shown in the following figure.

Figure 1 Basic components of a VPN

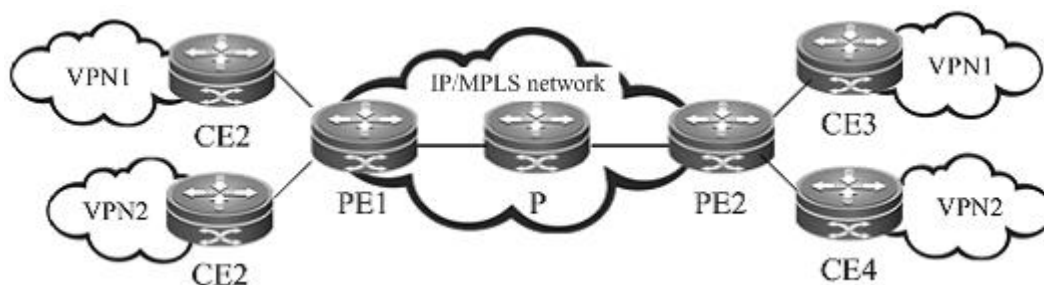

❖ CE

Located at customer edge, a CE logically belongs to a user VPN. One interface on the CE is directly connected to the PE device. The CE can be a host, router, or switch that may not support MPLS. As shown in the figure, CE1, CE2, CE3, and CE4 are CE devices.

❖ PE

A PE is an edge device on the SP backbone network. It can be a router, an ATM switch or an FR switch, as shown in PE1 and PE2 in the figure. A PE logically belongs to the service provider and is directly connected to a CE. You can connect one PE to multiple CEs. The PE is mainly responsible for receiving the VPN information from CEs and transmitting the information to other PEs, or receiving the VPN information from other PEs and sending it to the CEs. The PEs should support MPLS.

❖ P

The Provider Router (P) is a core device on the SP backbone network, as shown in P1, P2, and P3 in the figure. The P is not connected to CEs. It is responsible for routing and rapid forwarding. As a device on the core MPLS backbone network, the P should support MPLS. The P knows the routes to any destination on the backbone network but does not know the routes to a VPN.

❖ VRF

The VPN Routing and Forwarding table (VRF) is used to address the conflicts of local routes. Each connection between a PE and CE is associated with a VRF. One PE can have several VRFs to exchange route information with CEs. You can consider a VRF as a virtual router. Each virtual router should be connected to a CE to receive route information from the CE or notify the CE of the VPN route information. The VRF addresses the conflicts of local routes due to the adoption of the same address space by different VPNs. One VRF includes the following:

- 4) An independent routing table
- 5) A group of interfaces that belong to the VRF

6) A group of routing protocols that are used in the VRF

The VRF has two important attributes: Route Distinguisher (RD) and Route-Target (RT) attributes.

❖ RD

The RD is introduced to address the conflict of routes during the transmission.

You can consider the RD as a distinguisher. If different VPNs use the same network address and advertise their route information on the backbone network through BGP, the BGP module chooses and advertises only the best route from the overlapped addresses. As a result, some VPNs cannot obtain their route information. If the RD values are added to the overlapped addresses, the BGP module identifies the same network addresses based on the different RDs carried in the VPN information. In this manner, each VPN can obtain its own route information. The RD only serves as a distinguisher to identify the same network addresses. If address overlapping does not exist for different VPNs, you can configure no RD values.

Generally speaking, one VPN is specified with a unique RD value. In this manner, different VPNs have different RDs, facilitating the transmission of routing information on the backbone network. The RD value is generally defined as xx: xx, such as RD 1: 100, among which 1 stands for the AS number of the backbone network and 100 is a number specified by the user. One VPN route can carry only one RD value.

The RD consists of three fields: type, administrator, and assigned number. Based on the value of the type field, the encoding formats are classified into the following three types:

Figure 2 RD structure.

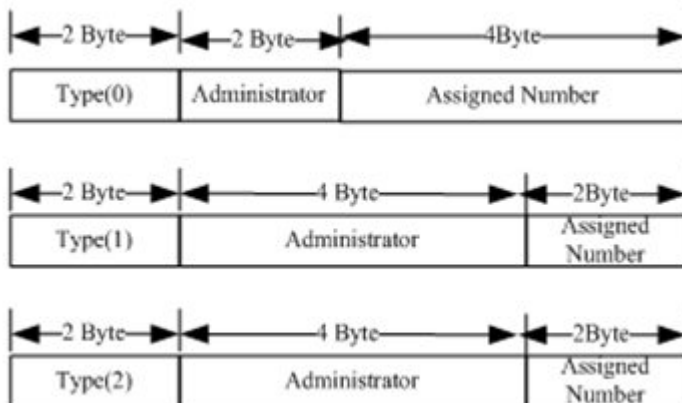

- 7) When Type = 0, the administrator field has two bytes and is marked by the AS number that must be of a public AS. The assigned number has four bytes that are managed by the service provider.
- 8) When Type = 1, the administrator field has four bytes and uses an IPv4 address that must be a global IP address. The assigned number has two bytes that are managed by the service provider.
- 9) When Type = 2, the administrator field has four bytes and is marked by the four-byte AS number. The assigned number has two bytes that are managed by the service provider.

❖ Route-Target

The introduction of the RT attribute is to let the VRF choose its route selection mode. The RT attributes are classified into export Route-Target and import Route-Target. A PE receives routes from a CE and adds Export Route-Target to the VPN routes and then notifies other PEs of the VPN routes. The PE determines whether to import the routes received from other PEs to the VRF based on the Import Route-Target. One principle is that when a PE receives a VPN route, the PE imports the route to the VRF only when at least one RT attribute carried in the route is the same as the Import RT in the VRF of the PE. In this manner, you can flexibly control the advertising of VPN routes. One VPN route can carry multiple RT values.

The BGP extended community attribute defines the RT encoding structure, as shown in the following figure.

Figure 3 RT structure

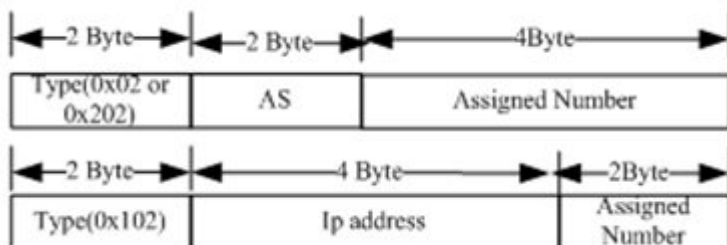

The definition of RT is similar to that of RD. For 0x02 and 0x202, the AS number must be a public one. For 0x102, the IPv4 address must be a global one rather than a private address.

❖ MP-BGP

The VPN route information is transmitted on the backbone network through BGP. The export RT attribute is carried in the BGP extended community attribute. The traditional BGP4, however, transmits only IPv4 routes and cannot carry the VPN route that includes RDs. Therefore, the BGP is extended to introduce new attributes. One of the biggest advantages of BGP is its scalability. The Multi-Protocol (MP-BGP) is a new attribute introduced to the original BGP to support multiple protocols. The MP-BGP can carry VPN information. In this manner, the VPN route takes up the form of RD + IP address prefix. By adding RDs to VPN routes exchanged between PEs, the MP-BGP allows VPN users to change the IPv4 routes to VPN-IPv4 routes and transmit them on the backbone network.

3.1.2 Protocol Specifications

❖ IETF RFC 4364: BGP/MPLS IP Virtual Private Networks (VPNs)

3.2 Configuration

- On a router, you must use the ip ref command on the interface to enable MPLS fast forwarding to improve forwarding performance of the router.

3.2.1 Default Configurations

By default, BGP/MPLS L3 VPN is disabled.

Functions	Default Setting
Basic BGP/MPLS L3 VPN functions	Disabled
VPN label distribution mode	Assigning labels to each VRF
Inter-AS VPN	Disabled
CSC VPN	Disabled
MPLS VPN Over GRE	Disabled

3.2.2 Configuring BGP/MPLS VPN

By default, tag assignment is performed based on each VRF, The PE removes the tag from the tagged packets and then forwards it based on the IP routing table.

To configure basic BGP/MPLS VPN functions, perform the following configurations:

- ❖ Configuring an MPLS Network (Mandatory)
- ❖
- ❖ Configuring a VPN Routing Instance (Mandatory)
- ❖ Configuring PEs to Transmit VPN Routes (Mandatory)
- ❖ Configuring Route Exchanging Between PEs and CEs (Mandatory)
- ❖ Configuring the VPN Label Distribution Mode (Optional)
- ❖ Configuring Import and Export Policies for VPN Routes (Optional)
- ❖ No import VPN route-target community //Import extended community attribute list (not configured)
- ❖

3.2.2.1 Configuring an MPLS Network

To use MPLS on the backbone network, you must configure the MPLS LDP on the P and PE to set up public tunnels. This means that you have to configure LDP on MPLS devices and enable MPLS on each interface. The configuration procedure is as follows:

Command	Function
Qtech# configure terminal	Enter the global configuration mode.

Qttech(config)# mpls ip	Enable MPLS globally.  Caution This command is not available on a switch chip.
Qttech(config)# mpls router ldp	Enable LDP and enter the LDP configuration mode.
Qttech(config-mpls-router)# ldp router-id interface loopback id [force]	Configure the LDP router ID. The IP address of the loopback interface is generally used as the router ID.
Qttech(config-mpls-router)# exit	Quit the LDP configuration mode.
Ruijie(config)# interface type ID	Enter the interface configuration mode.
Qttech(config-if-type ID)# ip address ip-address mask	Assign an IP address to the interface.
Qttech(config-if-type ID)# label-switching	<input checked="" type="checkbox"/> Enable MPLS on the interface at the public network side.
Qttech(config-if-type ID)# ip ref	Enable MPLS fast forwarding on the interface of a router.
Qttech(config-if-type ID)# mpls ip	Enable LDP on the interface.
Qttech(config-if-type ID)# show running-config	Display all configuration information.

Configure an MPLS network.

```
Qttech# configure terminal
Qttech(config)# mpls router ldp
Qttech(config-mpls-router)# ldp router-id interface loopback 0 force
Qttech(config-mpls-router)# exit
Qttech(config)# interface gigabitethernet 1/1
```

Use the **no switchport** command to switch the port mode on the switch series to the Routed Port mode. This command is not applicable to routers.

```
Qttech(config-if-gigabitethernet 1/1)# no switchport
Qttech(config-if-gigabitethernet 1/1)# ip address 192.168.10.1 255.255.255.0
Qttech(config-if-gigabitethernet 1/1)# label-switching
Qttech(config-if-gigabitethernet 1/1)# mpls ip
```

3.2.2.2 Configuring a VPN Routing Instance

A VPN routing instance is the VRF that is configured on PEs. The CE and P devices do not have VRFs.

The configuration of a VRF includes defining the VRF, assigning RD and RT values to the VRF, and associating the VRF with an interface. The configuration procedure is as follows:

Command	Function
Qttech# configure terminal	Enter the global configuration mode.
Qttech(config)# ip vrf vrf-name	Create a VRF and enter the VRF configuration mode.

Qtech(config-vrf)# rd <i>rd-value</i>	Set the RD value.
Ruijie(config-vrf)# route-target { both export import } rt-value	Set the RT value.
Qtech(config-vrf)# exit	Quit the VRF configuration mode.
Qtech(config)# interface type ID	Enter the interface configuration mode.
Qtech(config-if-type ID)# ip vrf forwarding <i>vrf-name</i>	Associate the interface with the VRF.
Qtech(config-if-type ID)# ip address <i>address mask</i>	Assign an IP address to the interface.
Qtech(config-if-type ID)# ip ref	<input checked="" type="checkbox"/> Enable MPLS fast forwarding on the interface of a router.
Qtech(config-if-type ID)# show running-config	Display all configuration information.

Configure a VRF and bind it to GigabitEthernet 1/1.

```
Qtech(config)# ip vrf vpn1
Qtech(config vrf)# rd 100: 1
Qtech(config vrf)# route target both 100: 1
Qtech(config vrf)# exit
Qtech(config)# interface gigabitEthernet 1/1
```

Use the **no switchport** command to switch the port mode on the switch series to the Routed Port mode. This command is not applicable to routers.

```
Qtech(config if gigabitEthernet 1/1)# no switchport
Qtech(config if gigabitEthernet 1/1)# ip vrf forwarding vpn1
Qtech(config if gigabitEthernet 1/1)# ip address 192.168.10.1
255.255.255.0
```



Caution

If the VRF on a PE is defined with an RD value or the PE is enabled with BGP VRF, the RD value cannot be modified or deleted. In this case, you can only delete the VRF and create the VRF again to set the RD value. Two different VRFs on the same PE cannot be assigned with the same RD.

If you enter the `ip vrf forwarding vrf-name` command, the IP address assigned to the interface earlier is deleted. In this case, you need to redefine the IP address in the interface mode.

3.2.2.3 Configuring PEs to Transmit VPN Routes

PEs transmit routing information through BGP. Since a PE needs to transmit VPN routing information rather than common IPv4 routing information with another PE, you need to enter the VPN address family mode to configure the PE to transmit VPN routes with the peer PE. The configuration procedure is as follows:

Command	Function
---------	----------

Qtech# configure terminal	Enter the global configuration mode.
Qtech(config)# router bgp <i>asn-num</i>	Create a BGP domain and enter the BGP configuration mode.
Qtech(config-router)# neighbor <i>ip-address remote-as</i> <i>asn-number</i>	Configure a BGP session.
Ruiije(config-router)# neighbor <i>ip-address</i> update-source <i>interface-name</i>	Set the interface address used to set up the MP-IBGP session as the source address. The address of the loopback interface is generally used as the source address.
Ruiije(config-router)# address-family vpnv4	Enter the VPN address family.
Qtech(config-router-af)# neighbor <i>ip-address activate</i>	Activate the BGP session to exchange VPN routes.
Qtech(config-router-af)# show running-config	Display all configuration information.

Set up an MP-BGP session with the neighboring PE at 1.1.1.1.

```
Qtech# configure terminal
Qtech(config)# router bgp 1
Qtech(config router)# neighbor 1.1.1.1 remote as 1
Qtech(config router)# neighbor 1.1.1.1 update source loopback 0
Qtech(config router)# address family vpnv4
Qtech(config router af)# neighbor 1.1.1.1 activate
```

3.2.2.4 Configuring Route Exchanging Between PEs and CEs

Configuring BGP Between PEs and CEs to Transmit Routing Information

To configure a BGP session with a CE, you need to enter the VRF address family mode on the PE and then configure the routing protocol with the CE. The configuration procedure on the PE is as follows:

Command	Function
Qtech# configure terminal	Enter the global configuration mode.
Qtech(config)# router bgp <i>pe-asn-num</i>	Create a BGP domain and enter the BGP configuration mode.
Qtech(config-router)# address-family ipv4 vrf <i>vrf-name</i>	Configure and enter the BGP VRF address family configuration mode.
Ruiije(config-router-af)# neighbor <i>ip-address remote-as</i> <i>ce-asn-num</i>	Set up an EBGP session with a CE.
Qtech(config-router-af)# show running-config	Display all configuration information.

Set up an EBGP session with the neighboring CE at 192.168.10.2.

```
Qtech# configure terminal
Qtech(config)# router bgp 1
Qtech(config router)# address family ipv4 vrf vrf1
Qtech(config router)# neighbor 192.168.10.2 remote as 2
```



Caution

If no RD is specified for the VRF, you will be reminded that no RD value is configured when you use the `address-family ipv4 vrf vrf-name` command to enter the specified VRF address family. As a result, you cannot enter the address family.

The configuration procedure for a PE peer on the CE is as follows:

Command	Function
Qtech# configure terminal	Enter the global configuration mode.
Qtech(config)# router bgp ce-asn-num	Create a BGP domain and enter the BGP configuration mode.
Ruijie(config-router)# neighbor ip-address pe-asn	Set up an EBGP session with a PE.
Qtech(config-router)# show running-config	Display all configuration information.

Set up an EBGP session with the PE at 192.168.10.1.

```
Qtech# configure terminal
Qtech(config)# router bgp 2
Qtech(config-router)# neighbor 192.168.10.1 remote-as 1
```

Configuring OSPF Between PEs and CEs to Transmit Routing Information

To run OSPF between a PE and CE, you must configure an OSPF instance for the VRF on the PE. The VRF then uses the OSPF instance to exchange routing information between the PE and CE. By redistributing BGP routes, the OSPF module sends the VPN routes received from other PEs to the CE. At the same time, by redistributing OSPF routes, the BGP module sends the VPN routing information that is sent to the PE by the CE to other PE peers.

The configuration procedure on the PE is as follows:

Command	Function
Qtech# configure terminal	Enter the global configuration mode.
Qtech(config)# router ospf ospf-id vrf vrf-name	Create an OSPF instance and enter the OSPF configuration mode.
Qtech(config-router)# network prefix mask area area-id	Configure an OSPF link.
Ruijie(config-router)# redistribute bgp subnets	Configure the OSPF module to redistribute BGP routes.
Ruijie(config-router)# exit	Quit the OSPF configuration mode.
Qtech(config)# router bgp asn	Enable BGP and enter the BGP configuration mode.
Qtech(config-router)# address-family ipv4 vrf vrf-name	Enter the BGP VRF configuration mode.
Qtech(config-router-af)# redistribute ospf ospf-id	Redistribute OSPF routes.
Qtech(config-router-af)# show running-config	Display all configuration information.

Run OSPF between a PE and CE to distribute VPN routes.

```

Qttech# configure terminal
Qttech(config)# router ospf 10 vrf vrf1
Qttech(config router)# network 192.168.10.0 255.255.255.0 area 0
Qttech(config router)# redistribute bgp subnets
Qttech(config router)# exit
Qttech(config)# router bgp 1
Qttech(config router)# address family ipv4 vrf vrf1
Qttech(config router af)# redistribute ospf 10

```

Transmitting Routing Information Between a PE and CE Through Static Configurations

The PE and CE run RIP. The VRF on the PE can exchange routing information between PE and CE. RIP redistributes BGP routes and transmits VPN routes from other PEs to the CE. Meanwhile, BGP redistributes RIP routes and transmits VPN routes assigned by the CE to the PE to other PE peers.

The configuration procedure is as follows:

Command	Function
Qttech# configure terminal	Enter the global configuration mode.
Qttech(config)# router rip	Create a RIP instance and enter the RIP configuration mode.
Ruiije(config-router)# address-family ipv4 vrf vrf-name	Enter the RIP VRF address family configuration mode.
Qttech(config-router)# version 2	Configure the version of RIP.
Ruiije(config-router-af)# network network-number [wildcard]	Configure RIP on the PE and CE.
Ruiije(config-router-af)# redistribute bgp	Configure RIP to redistribute BGP routes.
Ruiije(config-router-af)# exit	Exit the address family mode.
Qttech(config)# router bgp asn	Configure BGP and enter the BGP configuration mode.
Qttech(config-router)# address-family ipv4 vrf vrf-name	Enter the BGP VRF configuration mode.
Qttech(config-router-af)# redistribute rip	Redistribute OSPF routes.
Qttech(config-router)# show running-config	Display all configuration information.

Configure a static route on the PE to distribute VPN routes.

```

Qttech# configure terminal
Qttech(config)# router rip
Qttech(config router)# address family ipv4 vrf vrf1
Qttech(config router af)# version 2
Qttech(config router af)# network 192.168.10.0
Qttech(config router af)# redistribute bgp
Qttech(config router af)# exit address family
Qttech(config)# router bgp 1
Qttech(config router)# address family ipv4 vrf vrf1

```



```
Qtech(config router af)# redistribute rip
```

Transmitting Routing Information Between a PE and CE Through Static Configurations

In simple network environments, you can generally configure static routes. The configuration procedure is as follows:

Command	Function
Qtech# configure terminal	Enter the global configuration mode.
Qtech(config)# ip route vrf <i>vrf-name prefix mask interface-name nexthop</i>	Configure a static route.
Qtech(config)# router bgp asn	Enter the BGP configuration mode.
Qtech(config-router)# address-family ipv4 vrf <i>vrf-name</i>	Enter the BGP VRF address family configuration mode.
Qtech(config-router-af)# redistribute static	Redistribute static routes.
Qtech(config-router)# show running-config	Display all configuration information.

Configure a static route on the PE to distribute VPN routes.

```
Qtech# configure terminal
Qtech(config)# ip router vrf vrf1 192.168.20.0 255.255.255.0 gigabitEthernet 2/3 192.168.10.2
Qtech(config)# router bgp 1
Qtech(config router)# address family ipv4 vrf vrf1
Qtech(config router af)# redistribute static
```

3.2.2.5 Configuring the VPN Label Distribution Mode (Optional)

RFC 4364 describes two label distribution modes for L3VPN applications: route-based and VRF-based label distribution. The advantage of the former is rapid forwarding speed that allows a device to forward packets to the next hop by searching the ILM table. The disadvantage, however, is the large capacity of the ILM table. The advantage of the latter is the reduced capacity of the ILM table. This is because one label is assigned for each VRF and all routes in the VRF thus share the label. The disadvantage is the lower forwarding efficiency since it requires two times of table searching. The device should first locate the VRF of the packets based on the ILM table and then forward the packets by searching routes based on the destination IP address of the VRF.

By default, an L3VPN adopts the VRF-based label distribution mode. You can run the **alloc-label** command in the VRF configuration mode to modify the default label distribution mode. You can also choose different distribution modes for different VRFs.

To configure the label distribution mode, you should enter the privilege mode and perform the following configuration steps:

Command	Function
Qtech# config terminal	Enter the global configuration mode.
Qtech(config)# ip vrf <i>vrf-name</i>	Create a VRF and enter the VRF configuration mode.

Qtech(config-vrf)# alloc-label per-vrf	Assign one label to all routes in the VRF. When advertising VPN routes, the MP-BGP uses the same label for all routes.
Qtech(config-vrf)# alloc-label per-route	Assign one label to each route in the VRF. When advertising VPNv4 routes, the MP-BGP uses a different label for each route.
Qtech(config-vrf)# show running-config	Display all configuration information.



Caution

When you modify the label distribution mode, the MP-BGP cancels all routes advertised in the VPN and advertises the routes again.

By default, the VRF-based label distribution mode is adopted. In this case, a PE first pops out the received packets with labels and then chooses routes to forward the packets based on the IP routing table. For the M8600-MPLS card to forward MPLS packets, the device cannot select routes in the IP routing table and hit the FTN (which means the device selects a route and labels the packets again). If it does, the IP packets cannot be encapsulated and labeled, and thus are discarded. Avoid this scenario when you use the M8600-MPLS card to deploy VPN services.

3.2.2.6 Configuring Import and Export Policies for VPN Routes (Optional)

In most situations, you can define the route-target import attribute in the VRF configuration mode to determine the routes to be imported into the VRF and define the route-target export attribute to determine the RTs to be carried in the routes. These configurations are valid to all routes. In certain application scenarios that require accurate control on the import and export of VPN routes, however, you need to adopt policies. Enter the privilege mode and perform the following configuration procedure:

Command	Function
Qtech# config terminal	Enter the global configuration mode.
Qtech(config)# ip vrf vrf-name	Create a VRF and enter the VRF configuration mode.
Qtech(config-vrf)# import map routemap-name	Set the policy to import remote VPNv4 routes to the local VPN routes based on the rules defined in the route map.
Qtech(config-vrf)# export map routemap-name	Set the extended community attribute to export remote VPNv4 routes based on the rules defined in the route map.
Qtech(config-vrf)# show running-config	Display all configuration information.



Caution

The rules defined by using the import map command take effect after the extended community attribute defined in the VRF is imported. That is, remote VPN routes can enter the rules defined by using the import map command for further filtering only after the routes match the extended community attribute defined by the route-target import command for the VRF.

Configure a route map that exports VPN routes with the RT of 100:1 to vrf1.

```
Qtech# configure terminal
Qtech(config)# ip extcommunity list 1 permit rt 100: 1
Qtech(config)# route map IN RT FILTER
Qtech(config route map)# match extcommunity 1
Qtech(config route map)# exit
Qtech(config)# ip vrf vrf1
Qtech(config vrf)# rd 100: 2
Qtech(config vrf)# route target export 100: 30
Qtech(config vrf)# import map IN RT FILTER
Qtech(config route map)# end
Qtech# show ip vrf detail vrf1
VRF vrf1: default RD : 100: 2
Interfaces:
Vlan 1 //VRF bound interface
Export VPN route target communities: //Exported extended community attribute list
RT : 100: 30
No import VPN route target community //Import extended community attribute list (not
configured)
import map: IN RT FILTER//Import policy
```

3.2.2.7 Configuring a Static L3VPN FTN and ILM (Optional)

In most situations, the MP-BGP assigns labels to private routes and the public LSP is generated by running the LDP on a public network. You can also configure a static LSP to assign labels to private routes and set up private LSPs. To configure an FTN for the L3VPN on the PE, you should enter the privilege mode and perform the following configuration steps:

Command	Function
Qtech# config terminal	Enter the global configuration mode.
Qtech(config)# mpls static l3vpn-ftn <i>vrf-name ip-address/mask out-label out-label remote-pe ip-address</i>	Configure a static private FTN that specifies the egress of the FEC as another PE. In this case, you must specify the private label and the egress PE. The address of the egress PE is then used to configure the public LSP.
Qtech(config)# mpls static l3vpn-ftn <i>vrf-name fec-prefix/fec-mask local-forward nexthop interface-name nexthop-ip</i>	Configure a static private FTN that specifies the egress of the FEC as the local PE. In this case, you must specify the outgoing interface on the local PE and the next-hop address (the outgoing interface and the next hop is generally in another VRF). You can use this command when the local PE has several VRFs that belong to the same VPN.
Qtech# show running-config	Display all configuration information.

To configure an ILM for the L3VPN on the PE, you should enter the privilege mode and perform the following configuration steps:

Command	Function
Qtech# config terminal	Enter the global configuration mode.
Qtech(config)# mpls static ilm in-label in-label forward-action pop-l3vpn-nexthop vrf-name nexthop interface-name nexthop-ip-address fec ip-address/mask	Configure an ILM entry for the L3VPN on the PE. You need to specify the incoming label, the outgoing interface, and the next-hop address.
Qtech# show running-config	Display all configuration information.



Caution

The configured static private FTN and ILM take effect only after the corresponding public LSP is set up. To set up the public LSP, refer to Procedures for Configuring Basic MPLS. You can set up a public LSP through LDP or static configurations.

3.2.3 Configuring an Inter-AS VPN

On an actual network, different sites of VPN users may be located on different ASs and mutual communication is required between these sites. In this case, the VPN routes should be exchanged between different ASs. This technology is called the inter-AS VPN.

RFC 4364 introduces three types of inter-AS VPN schemes:

- ❖ OptionA: VRF-to-VRF mode
- ❖ OptionB: single-hop MP-EBGP mode
- ❖ OptionC: multi-hop MP-EBGP mode

3.2.3.1 OptionA: VRF-to-VRF Mode

Also referred to as the VRF back-to-back, the VRF-to-VRF mode features easy implementation. The ASBR of an AS sets up a VRF for each inter-AS VPN to bind the VRF to an interface. The VRFs on ASBRs then exchange VPN routes through the interface.

The purpose to create a VRF and bind it to an interface is as follows:

- ❖ Receive VPN routes from the local AS.
- ❖ Set up an EBGP connection between the VRF and the VRF of another AS to exchange IPv4 routes.

VRF-to-VRF inter-AS VPN

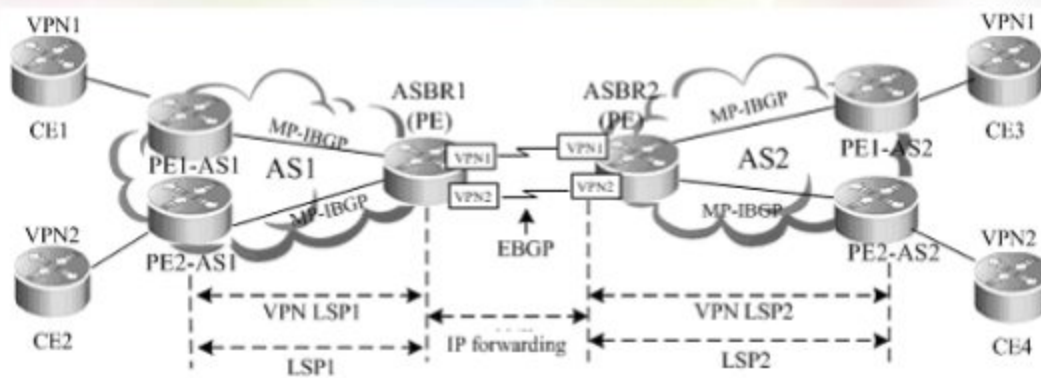

As shown in the preceding figure, the VRFs between the ASBRs set up common EBGP sessions to exchange IPv4 routes and the ASBRs and PEs set up MP-IBGP sessions to exchange VPN routes. For the VRF on an ASBR, the other VRF, with which the EBGP session is set up, is equivalent to a CE. This configuration scheme is similar to the common intra-domain scheme. The ASBRs and PEs set up MP-IBGP sessions to exchange VPN routes. The VRFs of ASBRs set up EBGP sessions in the BGP VRF address family mode to exchange IPv4 routes.

❖ Characteristics and limitations

The VRF-to-VRF mode is easy to implement by directly using MP-IBGP. The service deployment is also simple. This scheme, however, requires an interface (generally a logical sub-interface) for each inter-AS VPN on an ASBR. The number of bound interfaces at least should be equal to the number of inter-AS VPNs. You should configure an interface for each VPN on the ASBR, complicating network expansion. In addition, the separate creation of sub-interfaces for each VPN poses high requirements on ASBRs. As a result, this scheme is generally applicable to networks with a small number of inter-AS VPNs.

The configuration of OptionA is similar to that of a BGP/MPLS VPN and is not described here.

3.2.3.2 OptionB: Single-Hop MP-EBGP Mode

In the OptionA scheme, you need to configure a VRF for each VPN on an ASBR and bind the VRF to an interface. This is because VPN routes cannot be directly transmitted between EBGP and can only be carried through MP-IBGP. If the VPN routes can be directly transmitted between EBGP, you are not required to configure VRFs on the ASBR. This is clearly a better implementation mode. In this case, the OptionB scheme extends MP-IBGP and allows the direct transmission of VPN routes between ASBRs. This is called the single-hop EBGP, as shown in the following topology.

Figure 4 OptionB inter-AS VPN

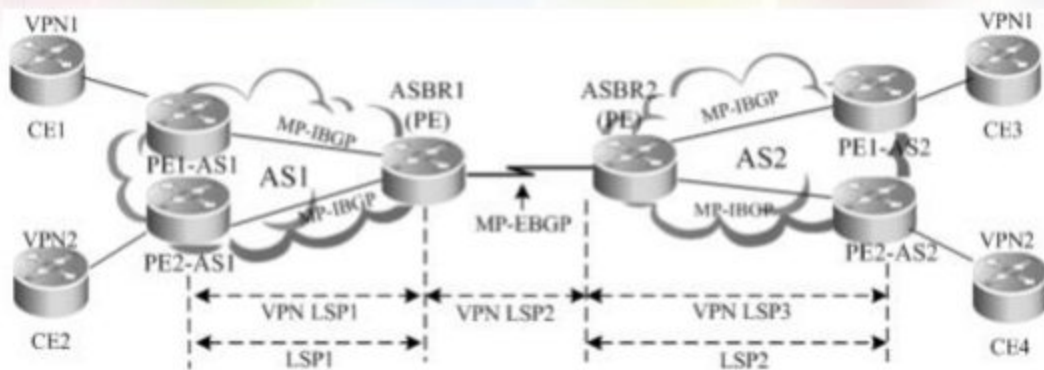

❖ Characteristics and limitations

The advantage of this MP-EBGP scheme is that you are not required to configure a sub-interface for each site of VPN users on an ASBR. You are also not required to set up the inter-AS LSP. The VPN routes are directly transmitted between single-hop MP-EBGP neighbors. The VPN routing information, however, is maintained and spread by the ASBRs between ASs. If a large number of VPN routes exist, the ASBRs are faced with heavy pressures. Since the ASBRs also generally assume forwarding tasks of IP packets on the public network, high requirements are imposed on these devices. In addition, the ASBRs cancel the RT filtering function for received VPN routes. The VPN routes on PEs may be spread to the ASBRs in another AS. This may lead to the leakage of VPN routes. As a result, the SPs, who exchange VPN routes, must reach trust agreements on route exchanging. The ASBRs should trust each other and perform corresponding route filtering policies. The OptionB scheme is applicable to networks with lots of inter-AS VPN services.

OptionB has two schemes:

- ❖ The ASBR does not change the next hop of a VPN route.
- ❖ The ASBR changes the next hop of a VPN route.

The following describes the configuration procedures of the two schemes.

Scheme 1: Next Hop Unchanged

When an ASBR receives VPN routes sent from the ASBR in another AS and sends the routes to the MP-IBGP neighbors in the local AS, the next hop of the routes is not changed. This mode is called the "OptionB Next Hop Unchanged Scheme". In this mode, the PEs and ASBRs in an AS still set up MP-IBGP sessions to exchange VPN routes and the two ASBRs set up MP-EBGP sessions to directly exchange VPN routes. When sending routes to an MP-IBGP neighbor, the ASBR does not change the next hop of the VPN routes received from the MP-EBGP neighbor. This requires that the PE in the AS should have a route to the next hop address (that is, the ASBR in another AS). For this purpose, you can configure the local ASBR to redistribute routes destined for the other ASBR to the IGP protocol in the local AS. In this manner, the address of the ASBR in another AS becomes reachable and you can set up an LSP through the LDP.

The configuration procedure is as follows:

- 10) Configuring Route Exchanging Between PEs and CEs

- 11) Configuring an IGP and MPLS Signaling Protocol in an AS
- 12) Configuring an ASBR to Cancel the Default RT Filtering Function
- 13) Configuring PEs and ASBRs in the Same AS to Exchange VPN Routing Information
- 14) Setting Up an MP-EBGP Session Between ASBRs
- 15) Configuring Route Map Rules to Filter VPN Routes (Optional)
- 16) Configuring an IGP to Redistribute ASBR Routes of Another AS

❖ Configuring Route Exchanging Between PEs and CEs

This procedure is similar to Configuring Route Exchanging Between PEs and CEs and is not described here.

❖ Configuring an IGP and MPLS Signaling Protocol in an AS

This procedure is similar to Configuring an MPLS Network and is not described here.

❖ Configuring an ASBR to Cancel the Default RT Filtering Function

By default, a PE rejects a VPN route sent by another PE (or ASBR), if the route is not imported by any VRF on the PE. Therefore, you should disable the default filtering on an ASBR so that the ASBR can receive all VPN routes from others PEs (or ASBRs), no matter whether these routes are imported into the local VRF or not.

Enter the privilege mode and perform the following configuration procedure:

Command	Function
Qtech# configure terminal	Enter the global configuration mode.
Qtech(config)# router bgp asn-number	Enable BGP and enter the BGP configuration mode.
Qtech(config-router)# no bgp default route-target filter	Disable RT filtering.
Qtech(config-router)# show running-config	Display all configuration information.

Disable RT filtering.

```
Qtech# configure terminal
Qtech(config)# router bgp 2
Qtech(config router)# no bgp default route target filter
```

❖ Configuring PEs and ASBRs in the Same AS to Exchange VPN Routing Information

This procedure is similar to Configuring PEs to Transmit VPN Routes and is not described here.

❖ Setting Up an MP-EBGP Session Between ASBRs

Set up directly-connected single-hop MP-EBGP sessions between inter-AS ASBRs to advertise VPN routes.

Enter the privilege mode and perform the following configuration procedure:

Command	Function
Qtech# configure terminal	Enter the global configuration mode.
Qtech(config)# router bgp <i>asn-number</i>	Enable BGP and enter the BGP configuration mode.
Qtech(config-router)# neighbor <i>asbr-address</i> remote-as <i>asbr-asn-number</i>	Configure an ASBR EBGP session.
Qtech(config-router)# address-family <i>vpn</i>	Enter the BGP VPN address family mode.
Qtech(config-router-af)# neighbor <i>asbr-address</i> activate	Enable the VPN route exchange with the peer.
Qtech(config-router-af)# show running-config	Display all configuration information.

Configure an EBGP neighbor at 20.20.20.2 and activate the VPN address family.

```
Qtech# configure terminal
Qtech(config)# router bgp 2
Qtech(config router)# neighbor 20.20.20.2 remote as 1
Qtech(config router)# address family vpnv4
Qtech(config router af)# neighbor 20.20.20.2 activate
```



Caution

You must run the label-switching command on the interface that connects two ASBRs to enable MPLS on the interface so that the links between the ASBRs can forward MPLS packets.



On a router, use the ip ref command on the interface to enable fast forwarding to improve forwarding performance.



Caution

If the ASBRs do not use directly connected addresses to set up an MP-EBGP session and use the loopback address with 32-bit mask length as the source address to set up an MP-EBGP session, you must use the neighbor ebgp-multihop command to enable multi-hop EBGP. At the same time, you must configure static routes on the ASBR to the loopback address on the peer, enable LDP or configure a static FTN (with an outgoing label as 3, indicating that the ASBR is the second but last hop).

❖ Configuring Route Map Rules to Filter VPN Routes (Optional)

In view of the AS security in actual applications, you can generally configure policies on ASBRs to send or receive only certain VPN routes. You can realize this purpose by filtering the RT extended community attributes of VPN routes. In addition, all VPN routes are saved since the default RF filtering function is disabled on the ASBR. In this case, you can configure VPN route policies to receive only inter-AS VPN routes sent from the local AS, lessening the capacity pressure of the ASBR.

To configure a filtering policy, you should enter the privilege EXEC mode and perform the following configuration steps:

Command	Function
Qtech# configure terminal	Enter the global configuration mode.
Qtech(config)# ip extcommunity-list { <i>expanded-list</i> expanded <i>list-name</i> <i>standard-list</i> standard <i>list-name</i> }	Create a rule for the extended community attribute list.
Qtech(config)# show ip extcommunity-list [<i>list-number</i> <i>list-name</i>]	Verify the configured rule for the extended community attribute list.
Qtech(config)# route-map <i>route-map-name</i> permit [<i>number</i>]	Create a route map rule and enter the route map configuration mode.
Qtech(config-route-map)# match extcommunity <i>extcommunity-name</i> <i>extcommunity-number</i>	Set the RT matching rule for a route map.
Qtech(config-route-map)# show route-map <i>route-map-name</i>	Display the route map rule.
Qtech(config-route-map)# exit	Quit the route map configuration mode.
Qtech(config)# router bgp <i>as-num</i>	Enable BGP and enter the BGP configuration mode.
Qtech(config-router)# address-family vpnv4	Enter the VPN address family.
Qtech(config-router-af)# neighbor <i>peer-address</i> route-map <i>route-map-name</i> in	Filter the VPN routes received from the ASBR in another AS.
Qtech(config-router-af)# neighbor <i>peer-address</i> route-map <i>route-map-name</i> out	Filter the VPN routes sent to the ASBR in another AS.
Qtech(config-router-af)# show running-config	Display all configuration information.

Configure an ASBR to receive VPN routes with an RT value of 100:1 from the MP-IBGP peer at 1.1.1.1.

```

Qtech# configure terminal
Qtech(config)# ip extcommunity list standard RT permit rt 100:1
Qtech(config)# show ip extcommuniy list RT
Named extended community standard list RT
permit rt 100:1
Qtech(config)# route map RT IN permit
Qtech(config route map)# match extcommunity RT
Qtech(config route map)# show route map RT IN
route map map, permit, sequence 10
  Match clauses:
  extcommunity (extcommunity list filter):RT
  Set clauses:
  Policy routing matches: 0 packets, 0 bytes
Qtech(config route map)# exit
Qtech(config)# router bgp 100
Qtech(config router)# neighbor 1.1.1.1 remote as 100
Qtech(config router)# neighbor 1.1.1.1 update source loopback 0
Qtech(config router)# address family vpnv4
Qtech(config router af)# neighbor 1.1.1.1 activate

```

```
Qtech(config router af)# neighbor 1.1.1.1 route map RT IN in
Qtech(config router af)# end
```

❖ Configuring an IGP to Redistribute ASBR Routes of Another AS

Since the ASBR does not change the next hop of VPN routes sent to the IBGP peer, the next hop address of VPN routes learnt by the PEs in the local AS is the ASBR address in another AS. Therefore, you must configure the PEs to learn the route to the next hop address. For the single-hop directly-connected MP-EBGP session where BGP is enabled to carry labels (through IPv4 routes or VPN routes), the MP-BGP module supports the automatic generation of a host route with 32-bit mask length and FTN entry (with the outgoing label 3) on the ASBR. In this manner, the tunnel egress is not terminated on the local ASBR. Therefore, as long as the ASBR redistributes the host route to the IGP in the local AS, the PEs can learn routes to the ASBR in the other AS.

Enter the privilege mode and perform the following configuration procedure:

Command	Function
Qtech# configure terminal	Enter the global configuration mode.
Qtech(config)# router igp	Enable an IGP that can be OSPF, RIP, or IS-IS.
Qtech(config-router)# redistribute connected subnets	Redistribute directly connected network segment routes.
Qtech(config-router)# show running-config	Display all configuration information.

Configure the OSPF module on an ASBR to redistribute the directly connected network routes.

```
Qtech# configure terminal
Qtech(config)# router ospf 1
Qtech(config router)# redistribute connected subnets
```

Scheme 2: Next Hop Changed

When an ASBR receives VPN routes sent from the ASBR in another AS and sends the routes to the PEs in the local AS, the next hop of the routes is changed. This mode is called the "OptionB Next Hop Changed Scheme." In this mode, the PEs and ASBRs in the same AS can set up MP-IBGP sessions to exchange VPN routes. Two ASBRs can set up MP-EBGP sessions to exchange VPN routes. Upon receipt of a VPN route from another ASBR neighbor, an ASBR changes the next hop as its own address when notifying the MP-IBGP peer in the AS of the route.

The configuration procedure is as follows:

1. Configuring Route Exchanging Between PEs and CEs
2. Configuring an IGP and MPLS Signaling Protocol in an AS
3. Configuring an ASBR to Cancel the Default RT Filtering Function
4. Setting Up an MP-IBGP Session Between an ASBR and PE and Modifying the Next Hop Address as its Own Address
5. Setting Up an MP-EBGP Session Between ASBRs

6. Configuring Route Map Rules to Filter VPN Routes (Optional)

❖ Configuring Route Exchanging Between PEs and CEs

This procedure is similar to Configuring Route Exchanging Between PEs and CEs and is not described here.

❖ Configuring an IGP and MPLS Signaling Protocol in an AS

This procedure is similar to Configuring an MPLS Network and is not described here.

❖ Configuring an ASBR to Cancel the Default RT Filtering Function

This procedure is similar to Configuring an ASBR to Cancel the Default RT Filtering Function in Scheme 1 and is not described here.

❖ Setting Up an MP-IBGP Session Between an ASBR and PE and Modifying the Next Hop Address as its Own Address

By default, an ASBR does not modify the next hop of the VPN route received from an MP-EBGP peer when the ASBR sends the route to the MP-IBGP peer. You can configure the ASBR to forcibly modify the next hop of the VPN route to the ASBR address in the local AS. In this manner, the PEs in the local AS are not required to learn the address of the peer ASBR. This is the major difference with Scheme 1 (Next Hop Unchanged Scheme).

Enter the privilege mode and perform the following configuration procedure:

Command	Function
Qtech# configure terminal	Enter the global configuration mode.
Qtech(config)# router bgp <i>asn-num</i>	Enable BGP and enter the BGP configuration mode.
Qtech(config-router)# neighbor <i>pe-address</i> remote-as <i>asn-num</i>	Set up an IBGP session with a PE.
Qtech(config-router)# neighbor <i>pe-address</i> update-source <i>interface-name</i>	Specify the local loopback interface as the source address to set up an IBGP session.
Qtech(config-router)# address-family vpnv4	Enter the BGP VPN address family configuration mode.
Qtech(config-router-af)# neighbor <i>pe-address</i> activate	Enable the VPN route exchange with the peer.
Qtech(config-router-af)# neighbor <i>pe-address</i> next-hop-self	Set the ASBR to modify the next hop as its own address when sending VPN routes to the IBGP neighbor.
Qtech(config-router-af)# show running-config	Display all configuration information.

Set up an MP-IBGP session, activate the VPN address family, and modify the next hop address as the ASBR address.

```
Qtech# configure terminal
Qtech(config)# router bgp 1
Qtech(config router)# neighbor 1.1.1.1 remote as 1
Qtech(config router)# neighbor 1.1.1.1 update source loopback 0
```

```

Qttech(config router)# address family vpnv4
Qttech(config router af)# neighbor 1.1.1.1 activate
Qttech(config router af)# neighbor 1.1.1.1 next hop self
Qttech(config router af)# end

```

❖ Setting Up an MP-EBGP Session Between ASBRs

This procedure is similar to Setting Up an MP-EBGP Session Between ASBRs in Scheme 1 and is not described here.

❖ Configuring Route Map Rules to Filter VPN Routes (Optional)

This procedure is similar to Configuring Route Map Rules to Filter VPN Routes (Optional) in Scheme 1 and is not described here.

3.2.3.3 OptionC: Multi-Hop MP-EBGP Mode

Both OptionA and OptionB can meet the networking requirements of inter-AS VPNs. In these two schemes, ASBRs are required to maintain and advertise VPN routes. If a large number of inter-AS VPN routes should be advertised in each AS, the ASBRs may become the bottleneck of further network expansion. To address this problem, a third scheme is developed, that is, the multi-hop MP-EBGP. In the multi-hop MP-EBGP mode, the PEs in different ASs set up multi-hop MP-EBGP sessions to directly exchange VPN routes. As a result, the ASBRs are not required to maintain or advertise VPN routes.

Figure 5 Multi-hop MP-EBGP

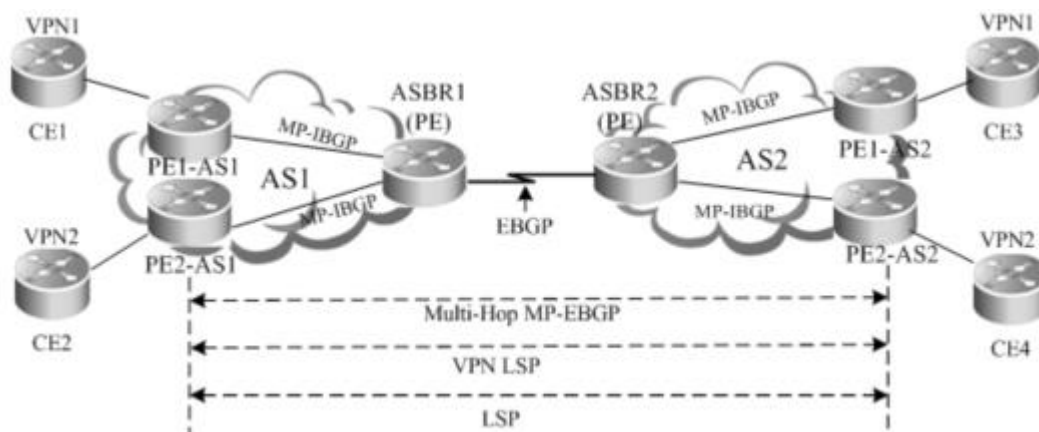

❖ Characteristics and limitations

In the multi-hop MP-EBGP mode, only PEs rather than ASBRs are required to store VPN information. This incurs complex PE configurations. This scheme is applicable to networks to be deployed with inter-AS VPN services in a large scale.

In terms of implementation principle, OptionC is further classified into two modes:

- 17) Enable label exchanging of IPv4 routes only between EBGP neighbors.

18) Enable label exchanging of IPv4 routes between EBGP and IBGP neighbors.

To facilitate scale expansion in OptionC, each AS is generally deployed with a route reflector (RR). The RRs of two ASs set up multi-hop MP-EBGP sessions to exchange VPN routes. Judged from deployment, OptionC can be referred to as the scheme of "Multi-Hop MP-EBGP Session Setup Between RRs".

The following describes the configuration procedures of these solutions.

Scheme 1: Enabling label exchanging of IPv4 routes only Between EBGP Neighbors

In this scheme, the IGP (such as OSPF or RIP) that runs on an ASBR is required to redistribute BGP routes so that each device in the AS can have routes to the PE in another AS. In the AS, you can use the LDP to set up an LSP for label distribution with the PE in another AS. On the directly connected ASBRs of the two ASs, enable label exchanging of IPv4 routes. In this manner, BGP serves as the MPLS signaling to assign labels to the PE in another AS and set up an inter-AS LSP.

The configuration procedure is as follows:

- 19) Configuring Route Exchanging Between PEs and CEs
- 20) Configuring an IGP and MPLS Signaling Protocol in an AS
- 21) Setting Up an EBGP Session Between ASBRs to Exchange Labels Through IPv4 Routes
- 22) Configuring an ASBR to Redistribute Inter-AS PE Routes Learnt from EBGP to the IGP
- 23) Configuring a Multi-Hop MP-EBGP Session

❖ Configuring Route Exchanging Between PEs and CEs

This procedure is similar to Configuring Route Exchanging Between PEs and CEs and is not described here.

❖ Configuring an IGP and MPLS Signaling Protocol in an AS

This procedure is similar to Configuring an MPLS Network and is not described here.

❖ Setting Up an EBGP Session Between ASBRs to Exchange Labels Through IPv4 Routes

Set up an EBGP session between inter-AS ASBRs and enable label exchanging of IPv4 routes. To import PE routes to the BGP, you can use the **network** command in the BGP IPv4 address family mode or run commands to redistribute IGP routes. In view of the AS security in actual applications, you are generally required to configure IPv4 route distribution policies on ASBRs. By configuring route map rules, you can control the routes sent to neighbors and specify whether the routes carry labels. Similar control is available for receiving routes.

Enter the privilege mode and perform the following configuration procedure:

Command	Function
---------	----------

Qtech# configure terminal	Enter the global configuration mode.
Qtech(config)# router bgp <i>asn-num</i>	Enable BGP and enter the BGP configuration mode.
Qtech(config-router)# neighbor <i>asbr-address</i> remote-as <i>asbr-asn-num</i>	Set up an EBGP session with an ASBR.
Qtech(config-router)# address-family ipv4	Enter the BGP IPv4 address family configuration mode.
Qtech(config-router-af)# neighbor <i>asbr-address</i> send-label	Configure the device to exchange labeled IPv4 routes with the ASBR peer in another AS.
Qtech(config-router-af)# network <i>pe-address</i> mask <i>mask</i>	(Optional) Configure PE addresses to be imported into the BGP routing table in the local AS, that is, host routes of each PE in the AS.
Qtech(config-router-af)# neighbor <i>asbr-address</i> route-map <i>routemap-name</i> out	(Optional) Configure a route distribution policy to control the routes sent to neighbors and specify whether the routes can carry labels, by defining a route map rule.
Qtech(config-router-af)# neighbor <i>asbr-address</i> route-map <i>routemap-name</i> in	(Optional) Configure a route distribution policy to receive only labeled routes by defining a route map rule.
Qtech(config-router-af)# show running-config	Display all configuration information.



Caution

You must run the label-switching command on the interface that connects two ASBRs to enable MPLS on the interface so that the links between the ASBRs can forward MPLS packets.



On a router, use the ip ref command on the interface to enable fast forwarding to improve forwarding performance.



Caution

If the ASBRs do not use directly connected addresses to set up an MP-EBGP session and use the loopback address with 32-bit mask length as the source address to set up an MP-EBGP session, you must use the neighbor ebgp-multihop command to enable multi-hop EBGP. At the same time, you must configure static routes on the ASBR to the loopback address on the peer, enable LDP or configure a static FTN (with an outgoing label as 3, indicating that the ASBR is the second but last hop).

Set up an EBGP session between ASBRs, enable label exchanging of IPv4 routes, and run the network command to import PE routes to the BGP module.

```
Qtech# configure terminal
Qtech(config)# router bgp 1
Qtech(config router)# neighbor 20.20.20.2 remote as 2
Qtech(config router)# address family ipv4
Qtech(config router af)# neighbor 20.20.20.2 send label
Qtech(config router af)# network 10.10.10.10 mask 255.255.255.255
Qtech(config router af)# end
```

In actual applications, an ASBR is generally required to distribute labels for PE routes for only inter-AS VPN services. For this purpose, you can run the **set mpls-label** command in the route map mode.

The **set mpls-label** command sets labels for routes. You can create a route map rule to advertise only inter-PE routes to the peer ASBR and set labels for the routes. Set route map rules and then run the **neighbor peer-address route-map rmap_name out** command in the BGP IPv4 address family mode to associate the rules with the route map.

In the following example, a route map is created to assign an MPLS label to the route with a prefix as 1.1.1.1/32, assign a common IPv4 route rather than label to only the route with a prefix as 1.1.1.2/32, and not to send neighbors routes that fail to match acl1 and acl2.

```
Router(config)# ip access list standard acl1
Router(config std nacl)# permit host 1.1.1.1
Router(config std nacl)# exit
Router(config)# ip access list standard acl2
Router(config std nacl)# permit host 1.1.1.2
Router(config std nacl)# exit
Router(config)# route map out as permit 10
Router(config route map)# match ip address acl1
Router(config route map)# set mpls label
Router(config std nacl)# exit
Router(config)# route map out as permit 20
Router(config route map)# match ip address acl2
Router(config)# router bgp 100
Router(config router)# neighbor 30.30.30.2 remote as 100
Router(config router)# neighbor 30.30.30.2 route map out as out
```

Similarly, to receive only labeled IPv4 routes, you can run the **match mpls-label** command in the route map mode. Set route map rules and then run the **neighbor peer-address route-map rmap_name in** command to associate the rules with the route map.

In the following example, a route map is created to receive labeled IPv4 routes from only the BGP peer at 30.30.30.2. The other routes are rejected.

```
Router(config)# route map match mpls
Router(config route map)# match mpls label
Router(config)# router bgp 100
Router(config router)# neighbor 30.30.30.2 remote as 100
Router(config router)# neighbor 30.30.30.2 route map match mpls in
```

❖ Configuring an ASBR to Redistribute Inter-AS PE Routes Learnt from EBGP to the IGP

When an ASBR learn a route to the PE in another AS from the peer ASBR, the ASBR should inform other PEs in the local AS of the route. The ASBR should also set up an LSP to the PE in another AS. In this manner, the ASBR can redistribute routes learnt from EBGP to the IGP and at the same time, enable the LDP to assign labels to BGP routes and then set up an LSP to the PE in another AS.

Enter the privilege mode and perform the following configuration procedure:

Command	Function
Qtech# configure terminal	Enter the global configuration mode.
Qtech(config)# router igp	Enter the IGP configuration mode.
Qtech(config-router)# redistribute bgp subnets [route-map routemap-name]	Redistribute BGP routes. Route filtering by using route map rules is optional.
Qtech(config-router)# exit	Quit the IGP configuration mode.
Qtech(config)# mpls router ldp	Enter the LDP configuration mode.
Qtech(config-mpls-router)# ldp router-id interface loopback 0 force	Configure the LDP router ID. The loopback address is generally used as the router ID.
Qtech(config-mpls-router)# advertise-labels for bgp-routes [<i>acl acl-name</i>]	Assign labels to BGP routes. ACL rules and filtering are optional.
Qtech(config-mpls-router)# show running-config	Display all configuration information.



Caution

By default, the LDP assigns labels to only IGP routes and does not assign labels to BGP routes. To assign labels to BGP routes, you can run the `advertise-labels for bgp-routes` command.

Configure an IGP and MPLS signaling in an AS.

```
Qtech# configure terminal
Qtech(config)# router ospf 1
Qtech(config router)# redistribute bgp subnets
Qtech(config router)# exit
Qtech(config)# mpls router ldp
Qtech(config mpls router)# ldp router id interface loopback 0 force
Qtech(config mpls router)# advertise labels for bgp routes
Qtech(config mpls router)# end
```

When an IGP redistributes the learnt BGP routes in the OptionC scheme, you can run the **redistribute bgp subnets route-map routemap-name** command in the IGP configuration mode to control the BGP routes to be redistributed to the IGP. In the LDP configuration mode, you can run the **advertise-labels for bgp-routes acl acl-name** command to control the labels assigned to BGP routes.

Configure ACL rules and route map routes so that:

- ❖ The IGP redistributes only routes 1.1.1.1 and 2.2.2.2.
- ❖ The LDP assigns labels to only routes 1.1.1.1 and 2.2.2.2.

The configuration procedure is as follows:

```
Router(config)# ip access list extended 101
Router(config ext nacl)# permit ip host 1.1.1.1 any
Router(config ext nacl)# permit ip host 2.2.2.2 any
Router(config ext nacl)# exit
```



```

Router(config)# route map pe routes
Router(config route map)# match ip address 101
Router(config route map)# exit
Router(config)# router ospf 1
Router(config router)# redistribute bgp subnets route map pe routes
Router(config route map)# exit
Router(config)# mpls router ldp
Router(config mpls router)# advertise labels for bgp routes acl 101

```

❖ Configuring a Multi-Hop MP-EBGP Session

In the earlier steps, the inter-AS LSP is already set up. At this time, you can directly set up a multi-hop MP-EBGP session on the PE to be deployed with inter-AS VPN services with the PE in another AS. The session can then exchange VPN routes.

To configure a multi-hop MP-EBGP session, you should enter the privilege mode and perform the following configuration steps:

Command	Function
Qtech# configure terminal	Enter the global configuration mode.
Qtech(config)# router bgp <i>asn-num</i>	Enable BGP and enter the BGP configuration mode.
Qtech(config-router)# neighbor <i>ebgp-peer-address</i> remote-as <i>ebgp-asn-num</i>	Set up a multi-hop EBGP session with the PE in another AS.
Qtech(config-router)# neighbor <i>ebgp-peer-address</i> update-source <i>interface-name</i>	Specify the device to use the loopback address to set up a neighbor relation with the EBGP peer.
Qtech(config-router)# neighbor <i>ebgp-peer-address</i> ebgp-multihop	Configure multi-hop attributes.
Qtech(config-router)# address-family vpnv4	Enter the BGP VPN address family configuration mode.
Qtech(config-router-af)# neighbor <i>ebgp-peer-address</i> activate	Enable the VPN route exchange with the peer.
Qtech(config-router-af)# exit	Quit the BGP VPN address family.
Qtech(config-router)# address-family ipv4	Enter the BGP IPv4 address family configuration mode.
Qtech(config-router-af)# no neighbor <i>ebgp-peer-address</i> activate	Disable the IPv4 route exchange.
Qtech(config-router)# show running-config	Display all configuration information.



Caution

The exchange of IPv4 routes is not required in a multi-hop MP-EBGP session. At least the routes of the two addresses used to set up the BGP session should be avoided. Otherwise, a PE has two routes to the PE in another AS. One route is advertised by the ASBR in the local AS and the other is by the multi-hop EBGP session. According to BGP specifications, the EBGP route has a higher priority over the IGBP route by default. As a result, the BGP module chooses the route advertised by the multi-hop BGP and this results in the continued flapping of routes on the PE to the PE in another AS. The VPN routes are thus not reachable.

Consider an example to set up a multi-hop EBGP session.

```
Qtech# configure terminal
Qtech(config)# router bgp 1
Qtech(config router)# neighbor 1.1.1.1 remote as 2
Qtech(config router)# neighbor 1.1.1.1 update source loopback 0
Qtech(config router)# neighbor 1.1.1.1 ebgp multihop
Qtech(config router)# address family vpv4
Qtech(config router af)# neighbor 1.1.1.1 activate
Qtech(config router af)# exit
Qtech(config router)# address family ipv4
Qtech(config router af)# no neighbor 1.1.1.1 activate
Qtech(config router af)# end
```

Scheme 2: Enabling label exchanging of IPv4 routes Between EBGP and IBGP Neighbors

In Scheme 1 (**Enabling label exchanging of IPv4 routes Only Between EBGP Neighbors**), the IGP and LDP in one AS are required to maintain the PE routes from another AS. That is, inter-AS PE routes should be advertised to each device on the AS. In view of the AS security in actual applications, the PE routes of another AS are generally not advertised to each device on the local AS. Instead, these routes should be owned by the BGP protocol so that they can be transparent to the IGP and LDP in the local AS. You can enable label exchanging of IPv4 routes between EBGP and IBGP neighbors.

This scheme differs from Scheme 1 in that the IGP on an ASBR is not required to redistribute BGP routes and the LDP is not required to assign labels to BGP routes, though the LDP is still responsible for the setup of the LSP in the local AS. The setup of an inter-AS LSP, however, requires the label exchanging of IPv4 routes between both IBGP and EBGP neighbors. The PEs are also required to push three consecutive layers of labels.

The configuration procedure is as follows:

- 24) Configuring Route Exchanging Between PEs and CEs
- 25) Configuring an IGP and MPLS Signaling Protocol in an AS
- 26) Setting Up an IBGP Session Between a PE and ASBR to Distribute Labels for IPv4 Routes
- 27) Setting Up an EBGP Session Between ASBRs to Exchange Labels Through IPv4 Routes
- 28) Configuring a Multi-Hop MP-EBGP Session

❖ Configuring Route Exchanging Between PEs and CEs

This procedure is similar to Configuring Route Exchanging Between PEs and CEs and is not described here.

❖ Configuring an IGP and MPLS Signaling Protocol in an AS

This procedure is similar to Configuring an MPLS Network and is not described here.

❖ Setting Up an IBGP Session Between a PE and ASBR to Distribute Labels for IPv4 Routes

This scheme differs from Scheme 1 mainly in this configuration procedure. In this scheme, the PE routes that are learnt by EBGP from another AS are not redistributed to the IGP in the local AS. Instead, the IBGP session between an ASBR and PE is used to transmit the PE routes of another AS and the BGP module is used to assign labels to the PE routes.

Enter the privilege mode and perform the following configuration procedure:

Command	Function
Qtech# config terminal	Enter the global configuration mode.
Qtech(config)# router bgp <i>asn-number</i>	Enable BGP and enter the BGP configuration mode.
Qtech(config-router)# neighbor <i>peer-address</i> remote-as <i>asn-number</i>	Set up an IBGP session with an ASBR (PE).
Qtech(config-router)# neighbor <i>peer-address</i> update-source <i>interface-name</i>	Configure the device to use the loopback address as the source address to set up the BGP session with an ASBR (PE) peer.
Qtech(config-router)# address-family ipv4	Enter the IPv4 address family.
Qtech(config-router-af)# neighbor <i>peer-address</i> send-label	Configure the device to exchange labeled IPv4 routes with an ASBR (PE) peer.
Qtech(config-router-af)# show running-config	Display all configuration information.



Caution

Before you enable the label exchanging of IPv4 routes for an IBGP session with an IBGP peer, run the `neighbor update-source` command to specify the source address of the IBGP session. This source address must be the address of the loopback interface; otherwise, the inter-AS LSP cannot be set up.

Configure a PE to set up an MP-IBGP session with the ASBR at 10.10.10.2.

```
Qtech# configure terminal
Qtech(config)# router bgp 1
Qtech(config router)# neighbor 10.10.10.2 remote as 1
Qtech(config router)# neighbor 10.10.10.2 update source loopback 0
Qtech(config router)# address family ipv4
Qtech(config router af)# neighbor 10.10.10.2 activate
Qtech(config router af)# neighbor 10.10.10.2 send label
Qtech(config router af)# exit
```

Configure an ASBR to set up an MP-IBGP session with the PE at 10.10.10.1 in the local AS.

```
Qtech# configure terminal
Qtech(config)# router bgp 1
Qtech(config router)# neighbor 10.10.10.1 remote as 1
Qtech(config router)# neighbor 10.10.10.1 update source loopback 0
```

```

Qttech(config router)# address family ipv4
Qttech(config router af)# neighbor 10.10.10.1 send label
Qttech(config router af)# end

```

❖ Setting Up an EBGP Session Between ASBRs to Exchange Labels Through IPv4 Routes

This procedure is similar to Setting Up an EBGP Session Between ASBRs to Exchange Labels Through IPv4 Routes in Scheme 1 and is not described here.

❖ Configuring a Multi-Hop MP-EBGP Session

This procedure is similar to Configuring a Multi-Hop MP-EBGP Session in Scheme 1 and is not described here.

Scheme 3: Setting Up a Multi-Hop MP-EBGP Session Between RRs

In the traditional OptionC scheme, the inter-AS VPN sites should be connected in full mesh mode. The addition of a single VPN site requires the setup of MP-MBGP connections with the PEs in other ASs, hindering the expansion of VPN sites. In this case, you can deploy an RR in each AS to solve this problem. Set up multi-hop MP-EBGP sessions between the RRs to exchange VPN routes.

Figure 6 Setting up a multi-hop MP-EBGP session between RRs in OptionC mode

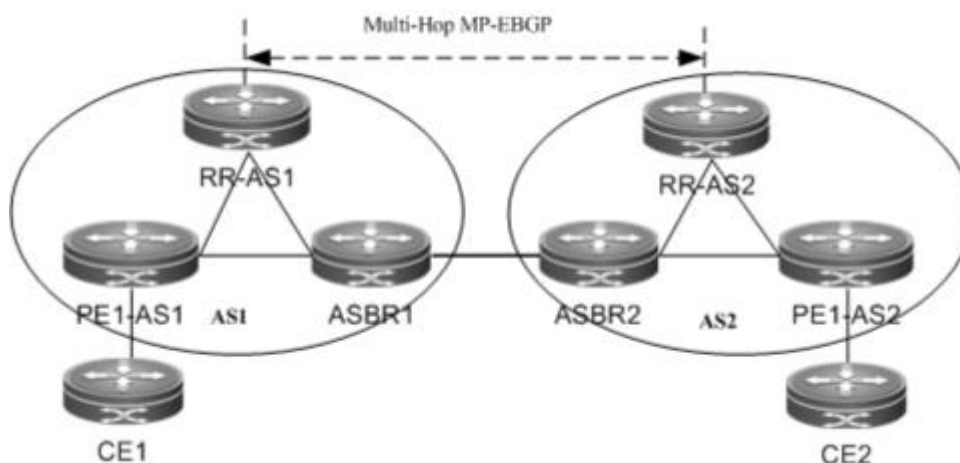

As shown in the preceding figure, the RRs in the two ASs set up a multi-hop MP-EBGP session to exchange VPN routes. The configuration procedure is as follows:

- 29) Configuring Route Exchanging Between PEs and CEs
- 30) Configuring an IGP and MPLS Signaling Protocol in an AS
- 31) Setting Up an MP-IBGP Session Between the RR and PE to Exchange Labels Through IPv4 Routes
- 32) Setting Up an IBGP Session Between the RR and ASBR to Assign Labels to IPv4 Routes
- 33) Setting Up an EBGP Session Between ASBRs to Exchange Labels Through IPv4 Routes

34) Configuring a Multi-Hop MP-EBGP Session

❖ Configuring Route Exchanging Between PEs and CEs

This procedure is similar to Configuring Route Exchanging Between PEs and CEs and is not described here.

❖ Configuring an IGP and MPLS Signaling Protocol in an AS

This procedure is similar to Configuring an MPLS Network and is not described here.

❖ Setting Up an MP-IBGP Session Between the RR and PE to Exchange Labels Through IPv4 Routes

Configure a PE to set up an MP-IBGP session with the RR to transmit VPN routes. At the same time, enable label exchanging of IPv4 routes for the session.

Enter the privilege mode and perform the following configuration procedure:

Command	Function
Qtech# config terminal	Enter the global configuration mode.
Qtech(config)# router bgp <i>asn-number</i>	Enable BGP and enter the BGP configuration mode.
Qtech(config-router)# neighbor <i>peer-address</i> remote-as <i>asn-number</i>	Set up the IBGP session.
Qtech(config-router)# neighbor <i>peer-address</i> update-source <i>interface-name</i>	Use the address of the loopback address as the source address to set up an IBGP session.
Qtech(config-router)# address-family ipv4	Enter the IPv4 address family.
Qtech(config-router-af)# neighbor <i>peer-address</i> Activate	Enable IPv4 route exchange.
Qtech(config-router-af)# neighbor <i>peer-address</i> send-label	Enable label exchanging of IPv4 routes.
Qtech(config-router-af)# neighbor <i>peer-address</i> route-reflector-client	Configure all PE peers as the clients of the IPv4 RR.
Qtech(config-router-af)# exit	Quit the IPv4 address family.
Qtech(config-router)# address-family vpnv4	Enter the VPN address family.
Qtech(config-router-af)# neighbor <i>peer-address</i> Activate	Enable the VPN route exchange with the peer.
Qtech(config-router-af)# neighbor <i>peer-address</i> route-reflector-client	Configure all PE peers as the clients of the VPN RR.
Qtech(config-router-af)# show running-config	Display all configuration information.

Set up an MP-IBGP session between the RR and PE. The configuration on the RR is as follows:

```
Qtech# configure terminal
Qtech# configure terminal
Qtech(config)# router bgp 1
Qtech(config router)# neighbor 10.10.10.1 remote as 1
Qtech(config router)# neighbor 10.10.10.1 update source loopback 0
```

```

Qttech(config router)# address family ipv4
Qttech(config router af)# neighbor 10.10.10.1 activate
Qttech(config router af)# neighbor 10.10.10.1 send label
Qttech(config router af)# neighbor 10.10.10.1 route reflector client
Qttech(config router af)# exit
Qttech(config router)# address family vpv4
Qttech(config router af)# neighbor 10.10.10.1 activate
Qttech(config router af)# neighbor 10.10.10.1 route reflector client
Qttech(config router af)# end

```

❖ Setting Up an IBGP Session Between the RR and ASBR to Assign Labels to IPv4 Routes

Set up an MP-IBGP session between the ASBR and RR to receive routes from the RR to the PEs in the local AS and send routes from the RR to the PEs in another AS. At the same time, enable label exchanging of IPv4 routes for the session.

Enter the privilege mode and perform the following configuration procedure:

Command	Function
Qttech# config terminal	Enter the global configuration mode.
Qttech(config)# router bgp <i>asn-number</i>	Enable BGP and enter the BGP configuration mode.
Qttech(config-router)# neighbor <i>peer-address</i> remote-as <i>asn-number</i>	Set up the IBGP session.
Qttech(config-router)# neighbor <i>peer-address</i> update-source <i>interface-name</i>	Use the address of the loopback address as the source address to set up an IBGP session.
Qttech(config-router)# address-family ipv4	Enter the IPv4 address family.
Qttech(config-router-af)# neighbor <i>peer-address</i> activate	Enable IPv4 route exchange.
Qttech(config-router-af)# neighbor <i>peer-address</i> send-label	Enable label exchanging of IPv4 routes.
Qttech(config-router)# show running-config	Display all configuration information.



Note For the IBGP session between an RR and ASBR, you are generally not required to set the ASBR as the client of the RR unless the ASBR also serves as a PE.

Set up an IBGP session between the RR and ASBR. The configuration on the RR (the configuration on the ASBR is similar) is as follows:

```

Qttech# configure terminal
Qttech(config)# router bgp 1
Qttech(config router)# neighbor 10.10.10.2 remote as 1
Qttech(config router)# neighbor 10.10.10.2 update source loopback 0
Qttech(config router)# address family ipv4
Qttech(config router af)# neighbor 10.10.10.2 activate

```

```
Qtech(config router af)# neighbor 10.10.10.2 send label
Qtech(config router af)# end
```

❖ Setting Up an EBGP Session Between ASBRs to Exchange Labels Through IPv4 Routes

This procedure is similar to Setting Up an EBGP Session Between ASBRs to Exchange Labels Through IPv4 Routes in Scheme 1 and is not described here.

❖ Configuring a Multi-Hop MP-EBGP Session

Set up a multi-hop MP-EBGP session between the RRs of two ASs to exchange inter-AS VPN routes. At the same time, disable the transmission of IPv4 routes for the session. The PE routes are advertised to another AS through the ASBR.

Enter the privilege mode and perform the following configuration procedure:

Command	Function
Qtech# config terminal	Enter the global configuration mode.
Qtech(config)# router bgp <i>asn-number</i>	Enable BGP and enter the BGP configuration mode.
Qtech(config-router)# neighbor <i>rr-address</i> remote-as <i>ebgp-asn-numbe</i>	Set up the EBGP session.
Qtech(config-router)# neighbor <i>rr-address</i> update-source <i>interface-name</i>	Use the address of the loopback address as the source address to set up an EBGP session.
Qtech(config-router)# neighbor <i>rr-address</i> ebgp-multihop	Configure multi-hop EBGP attributes.
Qtech(config-router)# address-family ipv4	Enter the IPv4 address family.
Qtech(config-router-af)# no neighbor <i>rr-address</i> activate	Disable IPv4 route exchange for the session.
Qtech(config-router-af)# exit	Quit the IPv4 address family.
Qtech(config-router)# address-family vpnv4	Enter the VPN address family.
Qtech(config-router-af)# neighbor <i>rr-address</i> Activate	Enable the device to exchange VPN routes with the RR in another AS.
Qtech(config-router-af)# neighbor <i>rr-address</i> next-hop-unchanged	(Optional) Configure the device not to change the next hop when advertising VPN routes to the peer.
Qtech(config-router)# show running-config	Display all configuration information.



Caution

By default, the device modifies the next hop of a route as its own address when advertising the route to an EBGP peer. Upon receipt of the VPN route, the PE site in another AS considers the next hop of the route as the RR. As a result, all inter-AS VPN traffic is transmitted through the RR. This is generally not the optimal forwarding path and has high requirements on the forwarding performance of the RR. To avoid the preceding situation, you can run the `neighbor next-hop-unchanged` command in the VPNv4 address family mode to configure the device not to change the next hop of a VPNv4 route sent to the BGP peer when you set up a multi-hop MP-EBGP session on the RR.

The exchange of IPv4 routes is not required in a multi-hop MP-EBGP session. At least the routes of the two addresses used to set up the BGP session should be avoided. Otherwise, a PE has two routes to the PE in another

AS. One route is advertised by the ASBR in the local AS and the other is by the multi-hop EBGP session. According to BGP specifications, the EBGP route has a higher priority over the IGBP route by default. As a result, the BGP module chooses the route advertised by the multi-hop BGP and this results in the continued flapping of routes on the PE to the PE in another AS. The VPN routes are thus not reachable.

Configure an RR to set up a multi-hop MP-EBGP session with the RR in another AS.

```
Qtech# configure terminal
Qtech(config)# router bgp 1
Qtech(config router)# neighbor 30.30.30.2 remote as 2
Qtech(config router)# neighbor 30.30.30.2 update source loopback 0
Qtech(config router)# neighbor 30.30.30.2 ebgp multihop
Qtech(config router)# address family ipv4
Qtech(config router af)# no neighbor 30.30.30.2 activate
Qtech(config router af)# exit
Qtech(config router)# address family vpnv4
Qtech(config router af)# neighbor 30.30.30.2 activate
Qtech(config router af)# neighbor 30.30.30.2 next hop unchanged
Qtech(config router af)# end
```

3.2.4 Configure Carrier's Carrier (CSC)

In a basic MPLS VPN, each site is a traditional IP network with simple network structure. However, in there are some special VPN users. For example, the VPN user itself is also a service provider who leases the VPN service of MPLS VPN service provider and then provides specific services for users. In such a case, the MPLS VPN service provider is called Provider Carrier or First Carrier, while the VPN user who is also a service provider is called Customer Carrier or Second Carrier. This networking model is called Carrier's Carrier (CSC).

Figure 7 Model of Carrier's Carrier

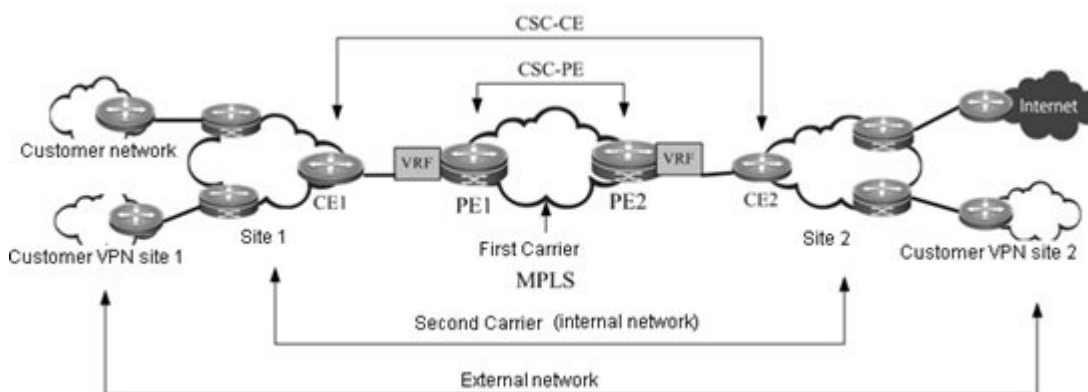

3.2.4.1 Basic concepts

- ❖ First Carrier

First Carrier is also called Provider Carrier, who provides MPLS VPN services for Second Carriers. In order to support Second Carriers to provide services for their users, the PE device of First Carrier must support CSC. The First Carrier PE providing services for Second Carriers is also called CSC-PE.

❖ Second Carrier

Second Carrier is also called Customer Carrier, who leases the MPLS L3VPN service from First Carrier in order to build its own internal network and then provide services for users. The Second Carrier CE connecting to the First Carrier is also called CSC-CE.

❖ Internal route

The internal routes refer to the routes inside the network of Second Carrier, namely the intra-AS routes. The internal routes are used to guarantee the intercommunication of Second Carrier's own network. Such routes must be jointly maintained by the First Carrier PE and the Second Carrier.

❖ External route

Since the Second Carrier is a service provider, its network may be connected to multiple third-party networks. The route between Second Carrier and the third-party network is called external route. If the Second Carrier provides traditional IP service for users, then the external routes will include routes of user network; if the Second Carrier is connected to Internet, then the external routes will include Internet routes; if the Second Carrier provides MPLS VPN service for users, then the external routes will include user's VPN routes.

Generally, there are tremendous external routes. To maintain good scalability, the First Carrier will not maintain external routes, which will be maintained independently by the Second Carrier.

❖ VPN tunnel

VPN tunnel is the LSP tunnel established between VPN devices. In the CSC model, the LSP tunnel between Second Carrier devices is the VPN tunnel.

3.2.4.2 Working principle

PE-CE route and label distribution

To achieve good scalability, the number of routes to be maintained by the First Carrier must be reduced. Therefore, the CSC model hands over external route maintenance to the Second Carrier, while the external traffic must use the VPN tunnel to cross First Carrier. To support CSC model, the First Carrier PE must support VPN tunnel.

To support VPN tunnel, the First Carrier PE (CSC-PE) and the Second Carrier CE (CSC-CE) must distribute the label binding information to each other. Depending on whether the CSC-PE and CSC-CE are in the same autonomous system, the following routing protocols may be used to exchange and distribute internal routes:

- ❖ If CSC-PE and CSC-CE are in the same autonomous system, IGP is generally used to exchange internal routes, and LDP is used to exchange label binding information.

- ❖ If CSC-PE and CSC-CE are in different autonomous systems, then EBGP is generally used to exchange internal routes, and EBGP IPv4 route/label distribution capability is also enabled to exchange internal routes and label binding information.

Typical application scenarios

The Second Carrier can be ordinary ISP or MPLS service provider. Depending on the type of Second Carrier network and the services provided by the Second Carrier for users, there are following typical application scenarios:

- ❖ Scenario I: IP core second-level ISP

Figure 8 Scenario I: IP core second-level ISP

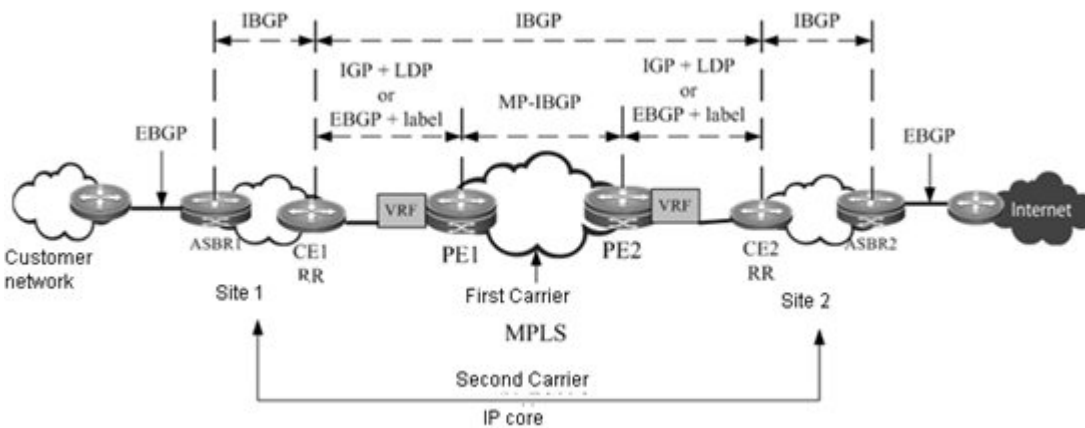

As shown in Fig 13, the Second Carrier is the IP core and provides network access service for users. Adjacencies are established between ASBR1, ASBR2, CE1 and CE2 to exchange external routes. CE1 and CE2 are Route Reflectors (RR) to reflect external routes between different sites. The Internet-access traffic of user flows from ASBR1 into the network of Second Carrier and then flows out of the Second Carrier network from ASBR2. When the traffic flows from CE1 to CE2, the traffic is forwarded in the VPN LSP tunnel.

- ❖ Scenario II: MPLS core second-level ISP

Figure 9 Scenario II: MPLS core second-level ISP

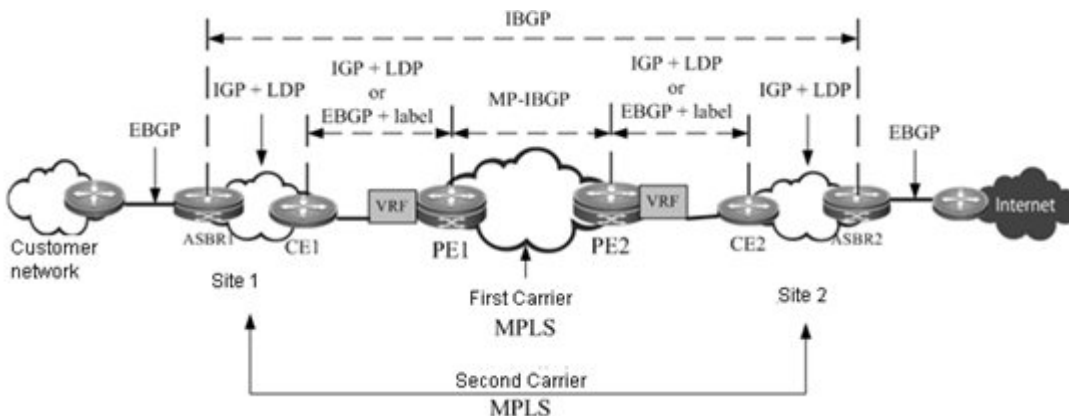

As shown in Fig 14, the Second Carrier is the MPLS core and provides network access service for users. Adjacency is established between ASBR1 and ASBR2 to exchange external routes. The Internet-access traffic of user flows from ASBR1 into the network of Second Carrier and then flows out of the Second Carrier network from ASBR2. When the traffic flows from ASBR1 to ASBR2, the traffic is forwarded in the VPN LSP tunnel.

❖ Scenario III: MPLS core second-level VPN provider

Figure 10 Scenario III: MPLS core second-level VPN provider

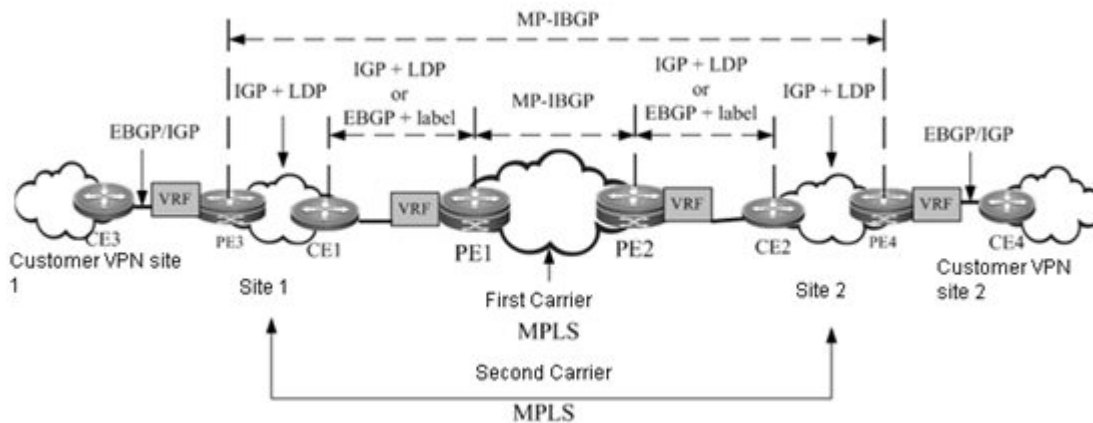

As shown in Fig 15, the Second Carrier is the MPLS core and provides MPLS L3VPN service for users. MP-IBGP adjacency is established between PE3 and PE4 to exchange user's VPN routes. The VPN LSP between PE3 and PE4 will act as the external tunnel of user VPN.

3.2.4.3 Configuration Steps

CSC configuration involves:

- ❖ Configure basic BGP/MPLS VPN for First Carrier
- ❖ Configure First Carrier to enable CSC
- ❖ Configure Second Carrier
- ❖ Configure user access for Second Carrier

Configure basic BGP/MPLS VPN for First Carrier

The configuration of basic BGP/MPLS VPN involves:

1. Configure MPLS network
2. Configure VRF
3. Configure MP-IBGP neighbor
4. Configure route exchanging between PE and CE

- ❖ Configure MPLS network

The configurations of this section is the same as "Configuring an MPLS network" in the previous section of "Configuring basic BGP/MPLS VPN Functions".

❖ Configure VRF

The configurations of this section is the same as "Configuring a VPN routing instance" in the previous section of "Configuring basic BGP/MPLS VPN Functions".



Caution CSC configuration requires "per-route" label allocation. Therefore, you need to execute "alloc-label per-route" command in VRF configuration mode to select the label allocation mode.

❖ Configure MP-IBGP neighbor

The configurations of this section are the same as "Configuring PEs to Transmit VPN Routes" in the previous section of "Configuring basic BGP/MPLS VPN Functions".

❖ Configure route exchanging between PE and CE

The configurations of this section is the same as "Configuring Route Exchanging Between PEs and CEs" in the previous section of "Configuring basic BGP/MPLS VPN Functions".



Caution In Scenario I (Fig 13): In the network of IP core second-level ISP, if PE and CE use EBGP to exchange internal routes, and since the external routes are exchanged using BGP and CE is the route reflector, a route map needs to be configured for PE-CE to filter external routes and avoid leaking external routes into the PE of First Carrier.

Configure First Carrier to enable CSC

Configure on the First Carrier PE to enable CSC. Depending on the protocol used for exchanging routes between PE and CE, the following two cases may apply:

1. PE and CE use LDP to distribute labels
2. PE and CE use EBGP to distribute labels

❖ PE and CE use LDP to distribute labels

If PE and CE use IGP to exchange routes, then execute the following commands on PE and CE respectively to configure PE and CE to use LDP to distribute labels.

The configuration steps of PE are shown below:

Command	Function
Qtech(config)# mpls router ldp vrf-name	VRF to enable LDP (PE).

Command	Function
Qtech(config-mpls-router)# ldp router-id interface <i>interface-name</i> force	Configure the RouterID of LDP.
Qtech(config-mpls-router)# advertise-labels for bgp-routes [acl <i>acl-name</i>]	Configure to distribute labels for BGP routes. By default, LDP will not allocate labels for BGP routes.
Qtech(config-mpls-router)# exit	Exit LDP instance configuration mode.
Qtech(config)# interface <i>interface-name</i>	Configure the interface connecting CE.
Qtech(config-if)# label-switching	Enable MPLS forwarding.
Qtech(config-if)# mpls ip	Enable LDP.
Qtech(config-if)# ip ref	In case of a router, enable fast forwarding (not applicable to a switch).
Qtech(config-if)# end	Exit interface configuration mode.
Qtech# show running-config	Display existing configurations.
Qtech# show mpls ldp bindings vrf <i>vrf-name</i>	Display LDP label binding information under this VRF instance.

The configuration steps of CE are shown below:

Command	Function
Qtech(config)# mpls router ldp	Enable LDP (CE).
Qtech(config-mpls-router)# ldp router-id interface <i>interface-name</i> force	Configure the RouterID of LDP.
Qtech(config-mpls-router)# exit	Exit LDP instance configuration mode.
Qtech(config)# interface <i>interface-name</i>	Configure the interface connecting PE.
Qtech(config-if)# label-switching	Enable MPLS forwarding.
Qtech(config-if)# mpls ip	Enable LDP.
Qtech(config-if)# end	Exit interface configuration mode.
Qtech# show running-config	Display existing configurations.
Qtech(config-if)# ip ref	In case of a router, enable fast forwarding (not applicable to a switch).
Qtech# show mpls ldp bindings	Display LDP label binding information.

❖ PE and CE use EBGP to distribute labels

If PE and CE use EBGP to exchange routes, then execute the following commands on PE and CE respectively to configure PE and CE to use EBGP to distribute labels.

The configuration steps of PE are shown below:

Command	Function
Qtech(config)# interface <i>interface-name</i>	Configure the interface connecting CE.
Qtech(config-if)# ip ref	In case of a router, enable fast forwarding (not applicable to a switch).
Qtech(config-if)# label-switching	Enable MPLS on the interface.
Qtech(config-if)# router bgp <i>asn</i>	Enter BGP configuration mode
Qtech(config-router)# address-family ipv4 vrf <i>vrf-name</i>	Enter IPv4 address family configuration mode

Qtech(config-router-af)# neighbor { <i>peer-address</i> <i>peer-group-name</i> } send-label	Enable BGP to carry labels for IP routes
Qtech(config-router-af)# end	Return to privilege mode
Qtech# show running-config	Display existing configurations.
Qtech# show bgp vpnv4 unicast vrf <i>vrf-name</i> labels	Display BGP label information

The configuration steps of CE are shown below:

Command	Function
Qtech(config)# interface <i>interface-name</i>	Configure the interface connecting PE.
Qtech(config-if)# label-switching	Enable MPLS on the interface.
Qtech(config-if)# ip ref	In case of a router, enable fast forwarding (not applicable to a switch).
Qtech(config-if)# router bgp <i>asn</i>	Enter BGP configuration mode
Qtech(config-router)# address-family ipv4	Enter IPv4 address family configuration mode
Qtech(config-router-af)# neighbor { <i>peer-address</i> <i>peer-group-name</i> } send-label	Enable BGP to carry labels for IP routes
Qtech(config-router-af)# end	Return to privilege mode
Qtech# show running-config	Display existing configurations.
Qtech# show ip bgp labels	Display BGP label information

Configure Second Carrier

Before configuration, please configure IGP for the Second Carrier network in order to guarantee the connectivity of Second Carrier network. Depending on the application scenarios of the Second Carrier, different configuration schemes will be adopted:

- ❖ Scenario I: IP core second-level ISP
- ❖ Scenario II: MPLS core second-level ISP
- ❖ Scenario III: MPLS core second-level VPN provider

Second Carrier provides Internet service based on IP core

In Scenario I, adjacencies are established between ASBRs and CEs to exchange external routes. CEs are route reflectors to reflect external routes between different sites. The configuration task mainly involves:

1. Configure an intra-site BGP session
 2. Configure a BGP session between CSC-CEs of different sites
 3. Configure route map filtering
- ❖ Configure an intra-site IBGP session

Configure an IBGP session between intra-site ASBR and CSC-CE, and configure CSC-CE as route reflector.

Command	Function
Qtech(config)# router bgp <i>asn</i>	Configure BGP router
Qtech(config-router)# neighbor { <i>peer-address</i> <i>peer-group-name</i> } remote-as <i>asn</i>	Configure BGP neighbor
Qtech(config-router)# neighbor { <i>peer-address</i> <i>peer-group-name</i> } route-reflector-client	Configure CSC-CE as the route reflector client
Qtech(config-router)# neighbor { <i>peer-address</i> <i>peer-group-name</i> } update-source <i>interface-name</i>	Configure BGP source address
Qtech(config-router)# neighbor { <i>peer-address</i> <i>peer-group-name</i> } next-hop-self	For ASBR, when configuring the router to advertise BGP routes, change the next hop to the router itself.

❖ Configure an IBGP session between CSC-CEs of different sites

A fully meshed IBGP session is established between CSC-CEs of different sites to exchange external routes of different sites.

Command	Function
Qtech(config)# router bgp <i>asn</i>	Configure BGP
Qtech(config-router)# neighbor { <i>peer-address</i> <i>peer-group-name</i> } remote-as <i>asn</i>	Configure BGP neighbor
Qtech(config-router)# neighbor { <i>peer-address</i> <i>peer-group-name</i> } update-source <i>interface-name</i>	Configure BGP source address
Qtech(config-router)# neighbor { <i>peer-address</i> <i>peer-group-name</i> } route-reflector-client	(Optional) Configure the CSC-CE of peer site as the router reflector client.
Qtech(config-router)# exit	Exit the BGP configuration mode.
Qtech(config)# recursive-route lookup isp	Enable the translation of BGP routes to the LSP tunnel.

❖ Configure route map filtering

When BGP is used to exchange internal routes, since CSC-CE is responsible for both external route propagation and internal route propagation, we must guarantee that only the EBGP session between CSC-CE and CSC-PE can propagate internal routes, and the IBGP session between CSC-CEs and between CSC-CE and ASBR can only propagate external routes, or else routing loop or chaos may incur. To achieve this goal, we must execute "**neighbor route-map {in | out}**" on IBGP neighbor and EBGP neighbor to filter the corresponding routes, and the AS-path filtering rule is generally used. Of course, you can also use other rules.

Command	Function
Qtech(config)# ip as-path access-list <i>access-list-number</i> { permit deny } <i>regex</i>	Configure AS-path ACL
Qtech(config)# route-map <i>route-map-name</i> { permit deny } <i>sequence-number</i>	Configure route map
Qtech(config-route-map)# match as-path <i>access-list-number</i>	Match AS-path ACL
Qtech(config-route-map)# exit	Exit global configuration mode

Qtech(config)# router bgp <i>asn</i>	Configure BGP router
Qtech(config-router)# neighbor { <i>peer-address</i> <i>peer-group-name</i> } route-map <i>route-map-name</i> { <i>in</i> <i>out</i> }	Apply route map to BGP neighbor

Second Carrier provides Internet service based on MPLS

In Scenario II, the Second Carrier is a MPLS core network in which adjacencies are established between ASBRs to exchange external routes. There is no need to propagate external routes via CSC-CE. The configuration task mainly involves:

1. Configure intra-site MPLS network

2. Configure inter-site IBGP session

❖ Configure intra-site MPLS network

The configuration of Second Carrier intra-site MPLS network is the same as "Configuring an MPLS network" in the previous section of "Configuring basic BGP/MPLS VPN Functions".



Note

You need to enable LDP on CSC-CE in order to establish sessions with other intra-site devices in order to build MPLS network. If CSC-CE and CSC-PE use BGP to exchange routes, then you must execute "advertise-labels for bgp-routes" on CSC-CE to allow LDP to distribute labels for BGP routes.

❖ Configure IBGP session between ASBRs of different sites

Configure the BGP session between local ASBR and ASBR of peer site in order to exchange external routes.

Command	Function
Qtech(config)# router bgp <i>asn</i>	Configure BGP
Qtech(config-router)# neighbor { <i>peer-address</i> <i>peer-group-name</i> } remote-as <i>asn</i>	Configure BGP neighbor
Qtech(config-router)# neighbor { <i>peer-address</i> <i>peer-group-name</i> } update-source <i>interface-name</i>	Configure BGP source address
Qtech(config-router)# neighbor { <i>peer-address</i> <i>peer-group-name</i> } next-hop-self	When configuring the ASBR router to advertise external routes, change the next hop to the router itself.
Qtech(config-router)# exit	Exit the BGP configuration mode.
Qtech(config)# recursive-route lookup isp	Enable the translation of BGP routes to the LSP tunnel.



Note

To reduce the configuration cost of fully meshed IBGP session, the RR role can be configured inside the site. Intra-site ASBR can establish BGP session with RR, while inter-site BGP session will only be established between RRs.

Second Carrier provides VPN service based on MPLS core

In Scenario III, the Second Carrier is a MPLS core network in which MP-IBGP adjacencies are established between Second Carrier PEs to exchange user's VPN routes. The configuration task mainly involves:

1. Configure intra-site MPLS network

2. Configure MP-IBGP neighbor

❖ Configure intra-site MPLS network

The configuration of Second Carrier intra-site MPLS network is the same as "Configuring an MPLS network" in the previous section of "Configuring basic BGP/MPLS VPN Functions".



Note

You need to enable LDP on CSC-CE in order to establish sessions with other intra-site devices in order to build MPLS network. If CSC-CE and CSC-PE use BGP to exchange routes, then you must execute "advertise-labels for bgp-routes" on CSC-CE to allow LDP to distribute labels for BGP routes.

❖ Configure PEs to establish MP-IBGP neighbors

Configure to establish MP-IBGP sessions between intra-site PEs of respective Second Carriers and between PEs of different sites in order to propagate VPN private routes served by the Second Carriers. The configuration of Second Carrier PE is the same as the PE configuration in the section of "Configuring Basic BGP/MPLS VPN Functions".



Note

To reduce the configuration cost of fully meshed MP-IBGP session, the RR role can be configured inside the site. Intra-site PEs can establish MP-IBGP session with RR, while inter-site MP-IBGP session will only be established between RRs.

Configure user access for Second Carrier

The configurations in this section are related to the services provided by the Second Carrier, and have nothing to do with the "Carrier's Carrier" model. If the Second Carrier provides IP service for users, please refer to the section of IP routing configuration; if the Second Carrier provides MPLS VPN service for users, please refer to the section of MPLS VPN configuration.

3.2.5 Configure MPLS VPN Over GRE

3.2.5.1 Basic concepts

The traditional MPLS VPN uses Label Switching Path (LSP) as the public-network tunnel -- VPN traffic flows from upstream PE to the downstream PE by means of label switching -- this will require the carrier's core network to fully support MPLS. For certain considerations or due to

certain limitations, if the carrier's core network cannot fully support MPLS, the MPLS VPN over GRE can provide a mechanism to allow the carrier to take GRE tunnel as a hop on the LSP tunnel, so as to guarantee the integrity of public-network LSP.

Figure 11 GRE tunnel

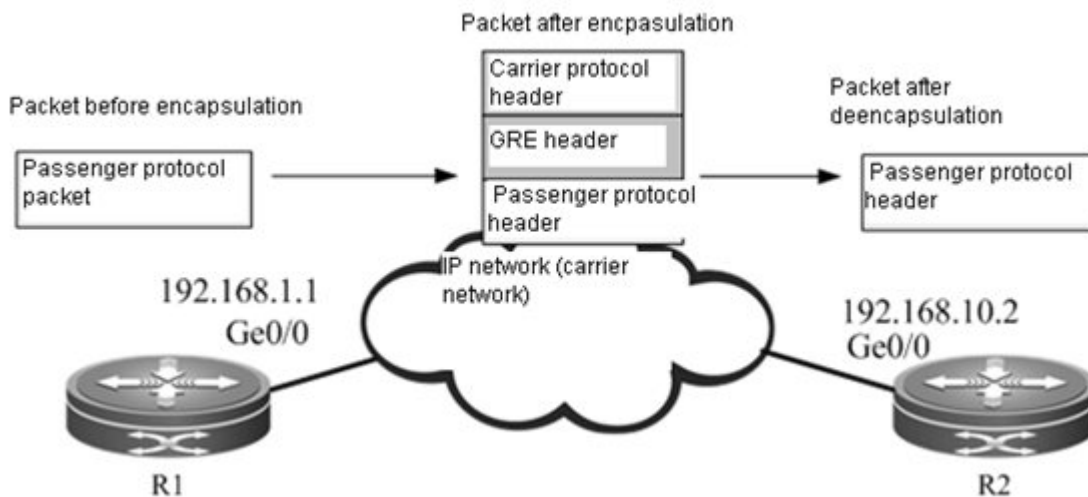

❖ GRE tunnel

GRE (Generic Routing Encapsulation) provides a mechanism to encapsulate the packets of one protocol (passenger protocol) into another protocol (carrier protocol). The encapsulated packets consist of: carrier protocol header, GRE header and original passenger protocol header. After being encapsulated by the carrier protocol, the passenger protocol packets can then be forwarded in the carrier network. After the encapsulated packets reach the destination address of carrier protocol, the destination device will de-encapsulate the packets and then forward the packets according to the inner-layer passenger protocol used by packets. Such an encapsulation technology allows passenger protocol packets to cross heterogeneous carrier network and reach the destination device. It is a tunnel encapsulation technology.

❖ Passenger protocol

Passenger protocol is the protocol being encapsulated during the process of GRE encapsulation. In the application scenario of MPLS VPN over GRE, the passenger protocol refers to packets carrying MPLS labels.

❖ Carrier protocol

Carrier protocol is the protocol used to encapsulate passenger protocol during the process of GRE encapsulation. In the application scenario of MPLS VPN over GRE, the carrier protocol is generally IPv4.

❖ Source address and destination address

While encapsulating the passenger protocol, we need to know the source address and destination address of carrier protocol, so that the encapsulated packets can be forwarded on the carrier

network. The abovementioned source address and destination address are the source address and destination address of GRE tunnel.

❖ Tunnel endpoint

When packets are transported on the tunnel, there is always one device carrying out carrier protocol encapsulation and another device carrying out de-encapsulation. The passenger protocol information can only be known and handled by these two devices, while other carrier network devices between them are unaware of the existence of passenger protocol. These two devices are the endpoints of GRE tunnel.

3.2.5.2 Working principle

In the traditional MPLS VPN, private-network traffic carrying inner-layer VPN label and outer-layer public-network label reaches the peer PE by means of label switching. When non-MPLS network exists in the backbone network, the LSP will become discontinuous. The GRE tunnel can help MPLS packets cross non-MPLS domain and realize continuous LSP.

GRE tunnel is a tunneling mechanism in IP network and support GRE with MPLS as the passenger protocol, so that two devices on both sides of the IP network can exchange MPLS packets. Considering GRE tunnel as a point-to-point logical link, devices at both ends of the tunnel directly establish IGP adjacency and LDP adjacency on this link to distribute routes and labels for LSP, while GRE tunnel becomes one hop of LSP.

MPLS as a passenger protocol

Take MPLS as the GRE tunnel of passenger protocol so that two devices interconnected through non-MPLS network can forward MPLS packets to each other. After label operation at one end of the tunnel, MPLS packets are encapsulated and then transported over the carrier network to the other end of tunnel; label switching is then carried out after packet de-encapsulation at the other end of tunnel. Fig 17 shows the format of encapsulated packets with IPv4 being the carrier protocol and MPLS being the passenger protocol.

Figure 12 MPLS as the passenger protocol

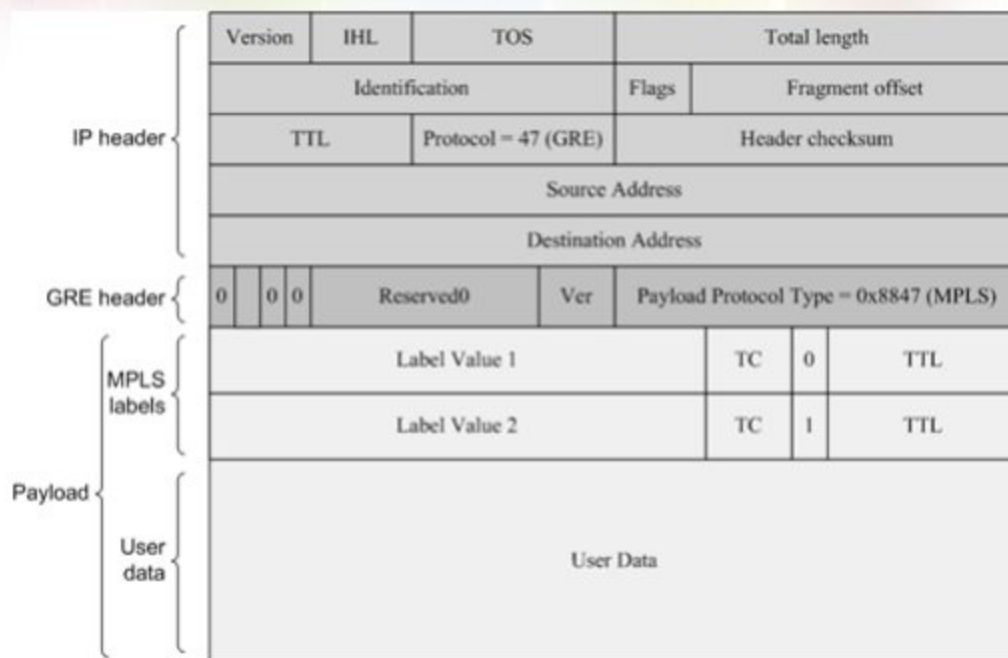

GRE tunnel as a point-to-point link

Figure 13 GRE tunnel link

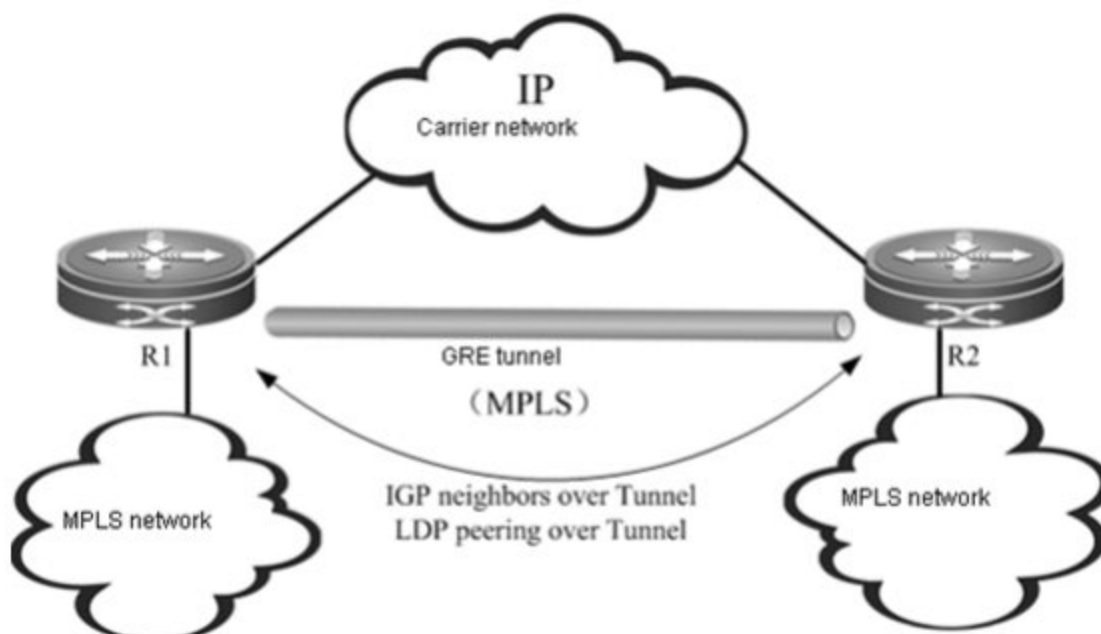

As shown in Fig 18, R1 and R2 are connected to a MPLS network respectively, while both routers are interconnected via a carrier network (IP). The GRE tunnel allows both endpoints (R1 and R2) to use the carrier network (IP) to transmit MPLS packets, so that two separated MPLS networks can be connected. GRE tunnel is the point-to-point logical link between R1 and R2. It bypasses the carrier network (IP) and becomes one part of the MPLS network, so that the MPLS networks at both ends of the tunnel can maintain continuity. Considering GRE tunnel as a point-to-point link, IGP protocol can run on the link, while LDP can also distribute labels between R1 and R2.

Introduction of tunnel traffic

In either carrier network (IP) or MPLS network, the traffic forwarding is driven by router. Therefore, dynamic routing protocol needs to be run in the carrier network (IP) and MPLS network. There are two possible scenarios: single routing instance and dual routing instances.

❖ Single routing instance

Figure 14 Single routing instance

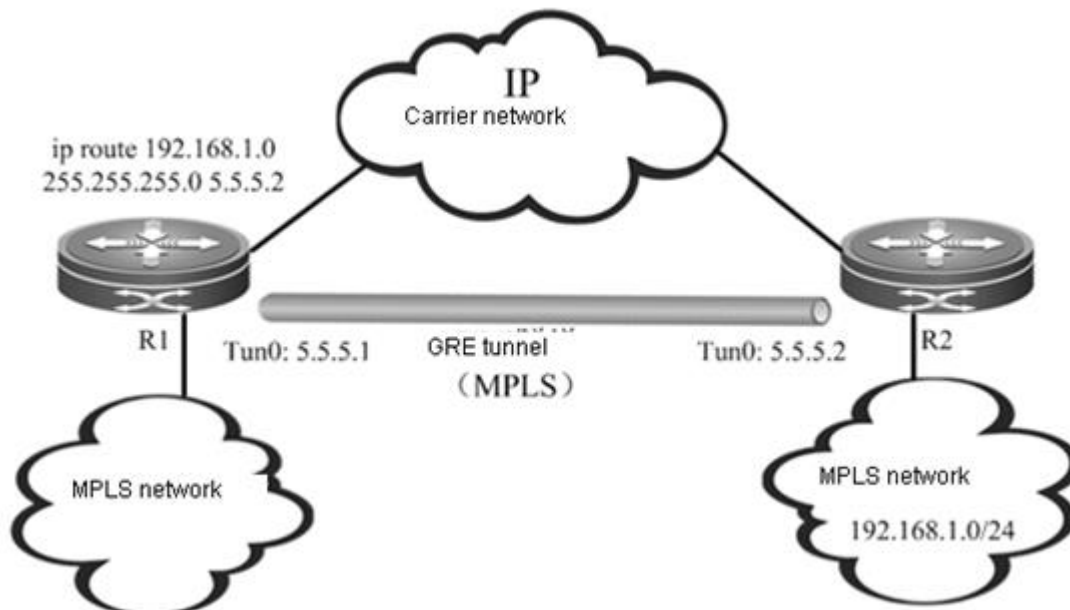

In this scenario, MPLS network and carrier network (IP) are in the same routing instance, and the entire network is of plane form, as shown in Fig 19. By default, since the Metric value of GRE tunnel is far greater than the ordinary link, no traffic will be introduced into the GRE tunnel (which means GRE tunnel is not the next-hop interface of any route). Therefore, we must configure static routes in order to introduce MPLS traffic into the GRE tunnel. The static routes must be configured in this scenario, and the number of static routes depends on the number of routing prefixes to be introduced into the GRE tunnel. The scalability is not satisfactory.

❖ Dual routing instances

Figure 15 Dual routing instances

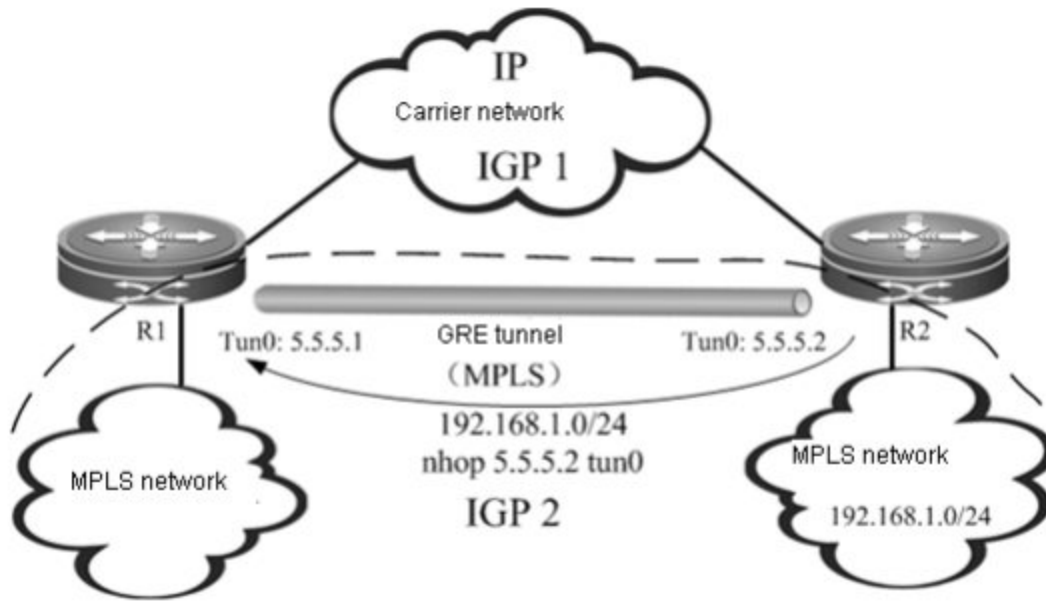

In this scenario, there are two different routing instances on each endpoint device of the GRE tunnel, as shown in Fig 20. One routing instance participates in route exchange in the carrier network (IP), while the other routing instance will participate in the route exchange in the MPLS network (including GRE tunnel link). By this time, R1 learns the route to remote MPLS network through GRE tunnel, with egress interface being GRE tunnel. The traffic can be introduced into GRE tunnel without configuring any static route.

Dual routing instances are actually dividing the network into different layers. As the upper-layer network, MPLS network (including GRE tunnel) acts as the backbone network running concurrent IGP instances, supporting MPLS and providing MPLS VPN service. As the bottom-layer network, the carrier network (IP) is the local network between R1 and R2 and runs independent IGP instances. If GRE tunnel is the "layer-3 interface" between R1 and R2, then the IP network and the IGP instance between R1 and R2 will be the "layer-2 network" and "layer-2 link protocol" between R1 and R2, as they guarantees the link state of GRE tunnel. Such relation can be indicated in Fig 1-17.

Figure 16 Dual IGP instances

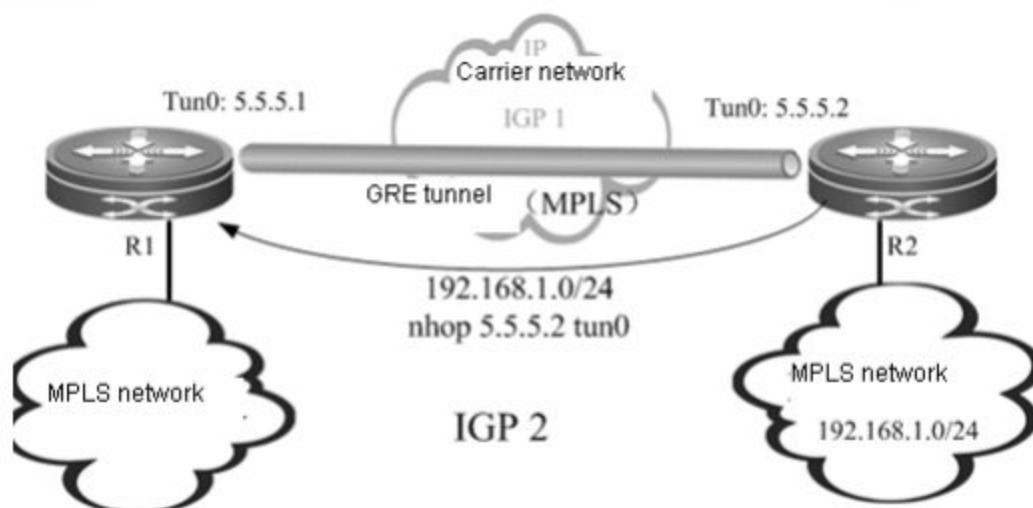

The scenario of dual routing instances divides the network into different layers and boasts better scalability. The following example is mainly based on this scenario.

Typical application

- ❖ Establish a GRE tunnel between PEs

Figure 17 Scenario I: PE-PE

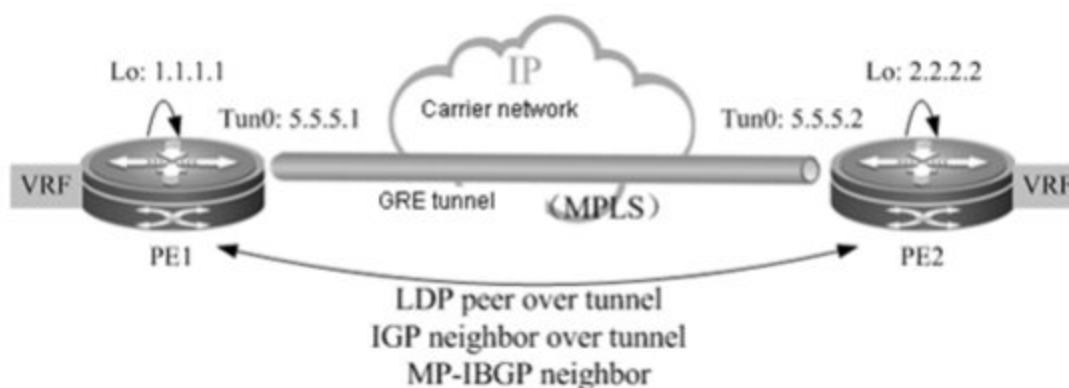

As shown in Fig 1-18, the core network between PEs is completely an IP network. GRE tunnel is established between two PEs, and the LSP between PE1 and PE2 has only one hop.

- ❖ Establish a GRE tunnel between Ps

Figure 18 Scenario II: P-P

As shown in Fig 1-19, PE1 and PE2 are in two MPLS domains. P1 and P2 are interconnected through IP network. The GRE tunnel is established between P1 and P2. The public-network LSP between PE1 and PE2 goes through P1 and P2, and the GRE tunnel between P1 and P2 is one hop of LSP.

- ❖ Establish a GRE tunnel between P and PE

Figure 19 Scenario III: P-PE

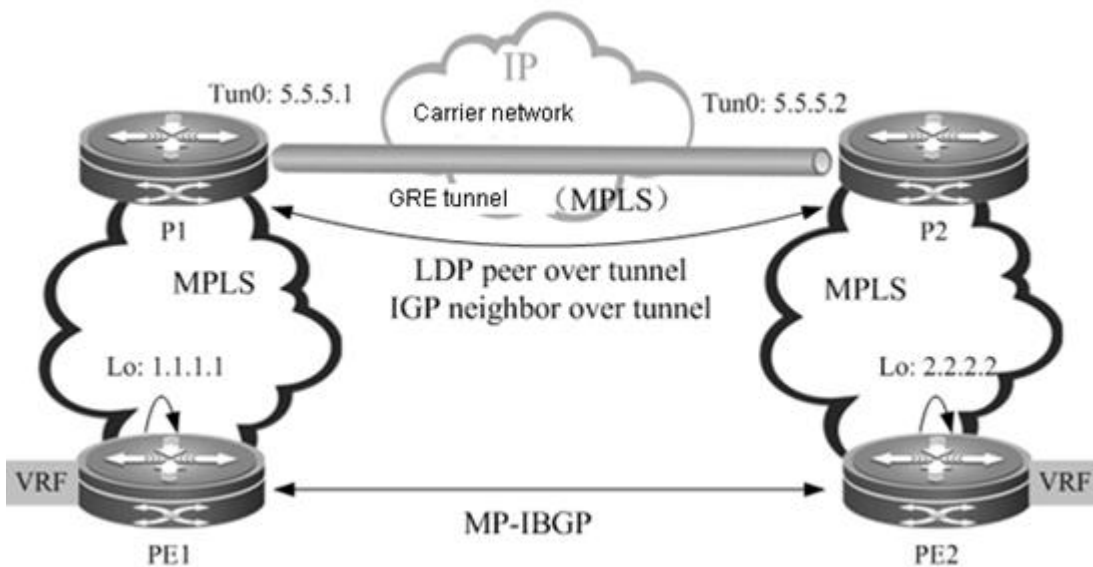

As shown in Fig 1-20, the network between PE1 and P doesn't support MPLS. The LSP is connected by establishing a GRE tunnel between PE1 and P device.

3.2.5.3 Protocol specification

- ❖ RFC 4023: Encapsulating MPLS in IP or GRE.
- ❖ RFC 4797: Use of Provider Edge to Provider Edge (PE-PE) Generic Routing Encapsulation (GRE) or IP in BGP/MPLS IP Virtual Private Networks.

3.2.5.4 Configuration steps

The configuration of MPLS VPN over GRE involves:

- ❖ Create tunnel interface
- ❖ Configure IGP route
- ❖ Configure MPLS network
- ❖ Configure MPLS VPN

Create tunnel

Execute the following command to create GRE tunnel (interface).

Configure the route to introduce traffic into the tunnel

There are two ways to introduce traffic into the tunnel, including:

1. Configure IGP

2. Configure static route

❖ Configure IGP

Generally, multiple OSPF processes are used to create different routing instances. One OSPF process learns the route to reach the destination address of tunnel, and the tunnel interface will become "UP" if the route is reachable. Another OSPF process will run OSPF on the GRE tunnel to establish session in order to learn the route to destination address of PE. For the configuration steps of multiple OSPF processes, please refer to the section about unicast routing protocol configuration.

❖ Configure static route

Configure static route directly: configure tunnel interface as the next hop of the route to the specified PE address.

Command	Function
Qtech(config)# ip route <i>ip-address address-mask</i> tunnel <i>tunnel-id</i>	Configure static route.



Caution

If static route is used to introduce traffic into the tunnel, then the destination address of tunnel cannot be the routing prefix of static route, namely the address of specified PE and the destination address of tunnel must be different. This is because the state of tunnel interface depends on the route to the destination address of tunnel, while the static route will cause the route to such destination address to rely on the state of tunnel interface, thus leading to the state oscillation of tunnel interface.

Configure tunnel interface to enable MPLS

Enable LDP protocol on the tunnel interface and enable MPLS forwarding function.

Command	Function
Qtech(config)# mpls ip	Enable MPLS globally. This command is not available on a switch chip.
Qtech(config)# mpls router ldp	Enable LDP globally.
Qtech(config-mpls-router)# ldp router-id interface <i>interface-name</i>	Configure the RouterID of LDP.
Qtech(config-mpls-router)# exit	Exit LDP configuration mode.
Qtech(config)# interface tunnel <i>tunnel-id</i>	Enter tunnel interface configuration mode.
Qtech(config-if)# ip ref	In case of a router, enable fast forwarding (not applicable to a switch).
Qtech(config-if)# mpls ip	Enable LDP on the interface.
Qtech(config-if)# label-switching	Enable MPLS forwarding on the interface.
Qtech(config-if)# exit	Exit interface configuration mode.

Configure MPLS VPN

The configuration of MPLS VPN involves:

- ❖ Configure VRF
- ❖ Configure MP-IBGP
- ❖ Configure route exchanging between PE and CE

The configurations are detailed in the section of "Configuring Basic BGP/MPLS VPN Functions".

3.2.6 Configure OSPF VPN extension

3.2.6.1 Introduction to L3VPN OSPF VPN extension

PE-CE OSPF feature

OSPF is widely applied IGP protocol. In most of the existing application scenarios, VPN user generally selects OSPF as the interior routing protocol. If OSPF protocol is deployed between PE and CE, you won't have to run other routing protocols again, thus simplifying CE configuration and management.

PE-CE OSPF feature will be introduced from the following four aspects.

- ❖ Domain ID

Domain ID refers to the OSPF domain to which the route belongs. When CE has learned an OSPF route from interior site of VPN, this route will be advertised to PE in type-1, type-2 or type-3 LSAs and redistributed to BGP to form VPN route. Meanwhile, the domain ID will also be redistributed to BGP together with the route and advertised as the Extended Communities attribute in the VPN route. When other PEs receive this VPN route and redistribute to the VRF OSPF instance, the domain ID will also be redistributed to the corresponding VRF OSPF instance together with this route. If VRF OSPF instance confirms that domain ID contained in the route is same as the domain ID of this VRF OSPF instance, then the route will be advertised to CE as an internal route. Contrarily, if VRF OSPF instance confirms the domain ID contained in the route is different from the domain ID of this VRF OSPF instance, then the route will be advertised to CE as an external route.

As shown below, for a route that belongs to the same OSPF domain, CE1 advertises the route to PE1 in type-2 LSA and then VPN route is formed and advertised to PE2, which will receive this route and redistribute to VRF OSPF instance. Since the VRF OSPF instance shares the same domain ID with this VPN route, this site will eventually be advertised to VPN sites in the form of internal route.

Figure 20

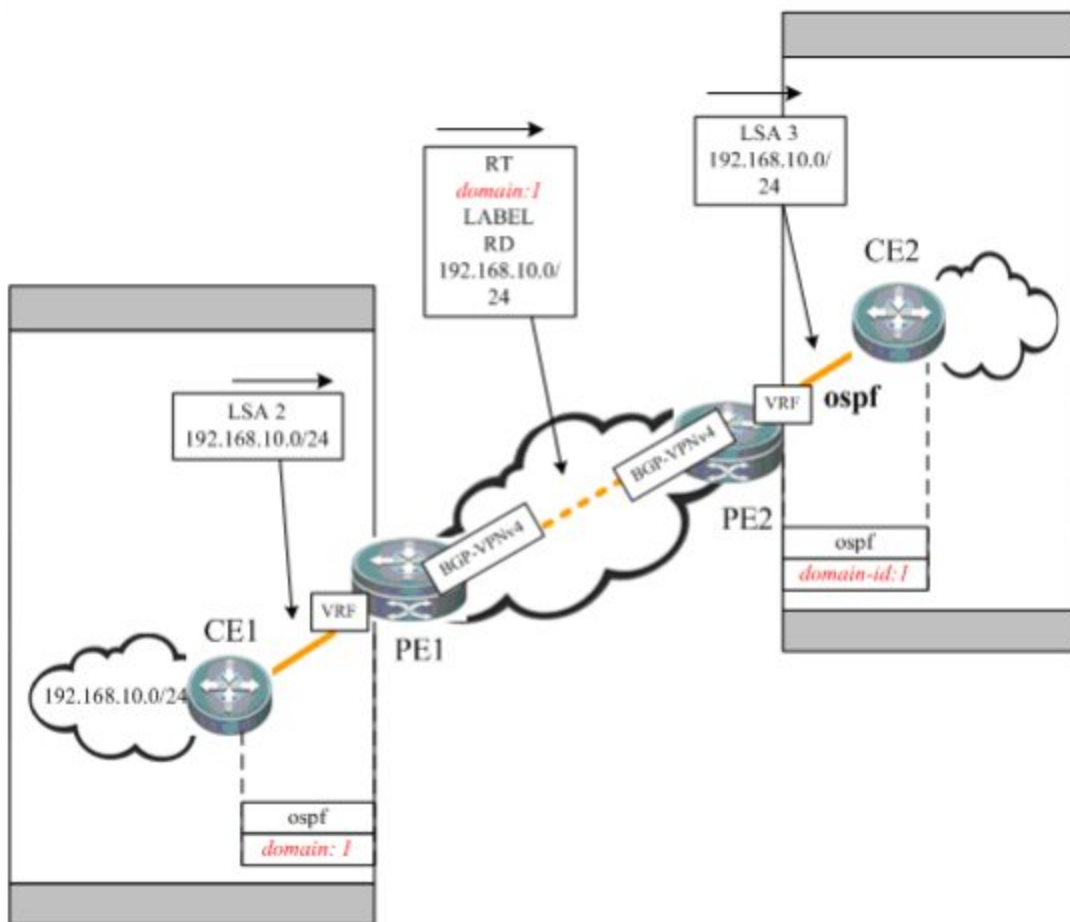

❖ DN bit

DN bit is a loop detection technique when OSPF protocol is run between PE and CE. In certain circumstance, running OSPF between PE and CE may cause loops. For example, when multiple PEs are connected to one VPN site, if one PE advertises the VPN route learned to the VPN site, and such route is further advertised to another PE by running OSPF protocol inside the VPN site and then broadcasted, routing loop may take place.

As shown below: The route from 192.168.10.0/24 is advertised by PE1 to PE2 and PE3. CE2 advertises the route to CE3 through OSPF protocol. The route is then advertised to PE3 and redistributed to the BGP protocol of PE3. PE3 selects the protocol redistributed by OSPF and converts this route into VPN-IPV4 route before advertisement, thus causing routing loop.

Figure 21

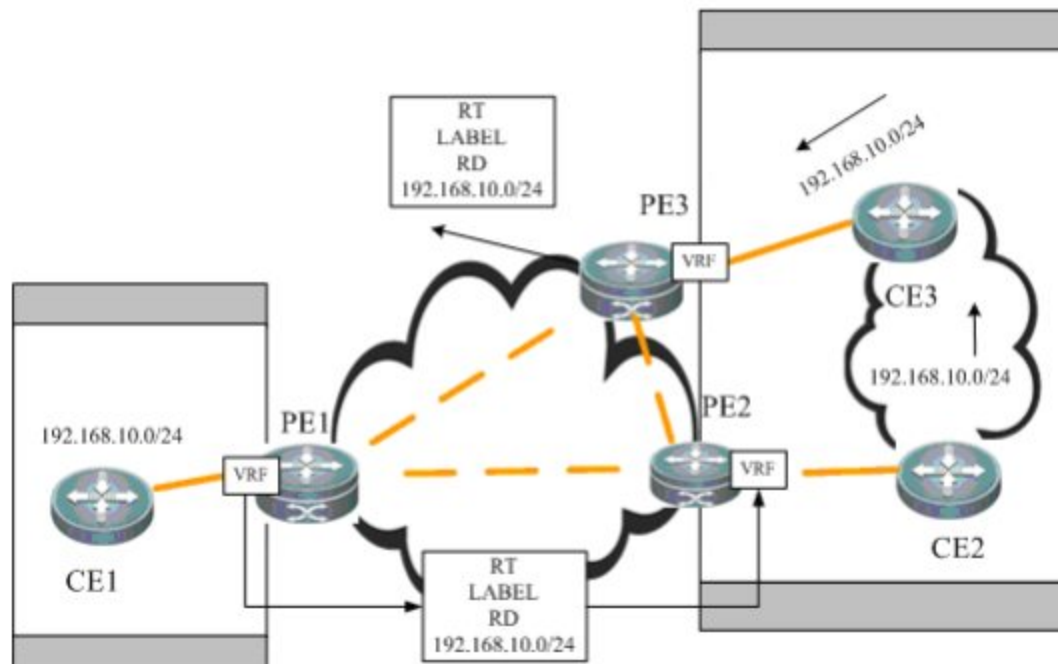

To avoid such potential loop, when PE advertises type-3, type-5 or type-7 LSAs to CE, it will set DN bit in the optional field of LSA. When other PE sites receives any LSA containing DN bit in the optional field, the OSPF protocol on PE won't allow this LSA to participate in OSPF computation.

❖ VPN route tag

VPN route tag is another loop detection technique. When OSPF protocol is run between PE and CE, the corresponding VRF OSPF instance on PE will by default have a route tag called "VPN route tag". The VRF OSPF instance on PE introduces VPN route and converts the route into type-5 or type-7 LSA. When LSA is advertised to CE, this LSA will carry VPN route tag. In the circumstance in which one VPN site is connected with multiple PEs, if PE receives a type-5 or type-7 LSA that carries VPN route tag and this VPN route tag is the same as the that of OSPF instance, then this LSA won't participate in OSPF route calculation.

❖ PE-CE inter-area deployment

Under normal circumstances, the link between PE and CE can be in any OSPF area. However, if the link between PE-CE falls into a non-0 area, then PE is an ABR to the OSPF area where the CE is in. This may cause some problems as the OSPF protocol acting as ABR device has the following features:

- ❖ ABR only calculates the type-3 LSA in the backbone area
- ❖ ABR only forwards type-3 LSA in the backbone area to the non-backbone area

As shown below, if the link between PE and CE is in non-0 area, then PE will redistribute the VPNv4 route advertised by MP-BGP to OSPF and restore to type-3 LSA to be advertised to CE1, which will not calculate the non-backbone area LSAs. Therefore, these LSAs will not be advertised to routers

in Area0, and intra-VPN sites won't learn the route to other sites. Accordingly, special attention shall be paid when deploying non-0 area between PE and CE.

Figure 22

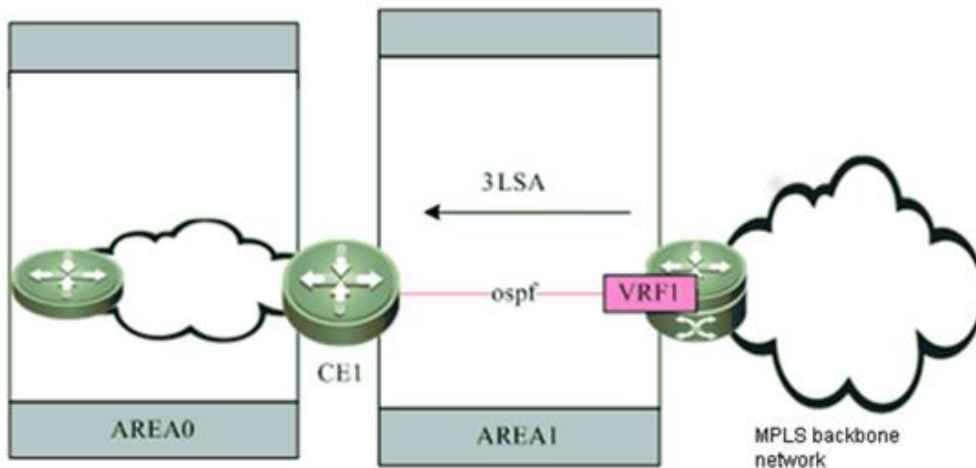

Generally, in L3VPN applications, if OSPF is run between PE and CE to exchange VPN routes, it is suggested not to deploy backbone area at intra-VPN site. In practice, if intra-VPN routers other than the PE sites also fall into the backbone area, then there must be at least one router at this intra-VPN site to connect with PE, and the link between CE and PE must belong to Area 0, so that intra-area routes and external routes can be propagated between PE and VPN site.

Sham link

Sham-link is not a real link. It refers to the "virtual link" established between the VRFs of two PEs. The Sham-link is same as the normal OSPF link. With its own OSPF interface, it can send OSPF protocol packets, establish neighbors and send LSAs. When LSAs are flooded over the sham link, all OSPF route types won't be changed, as shown below.

Figure 23

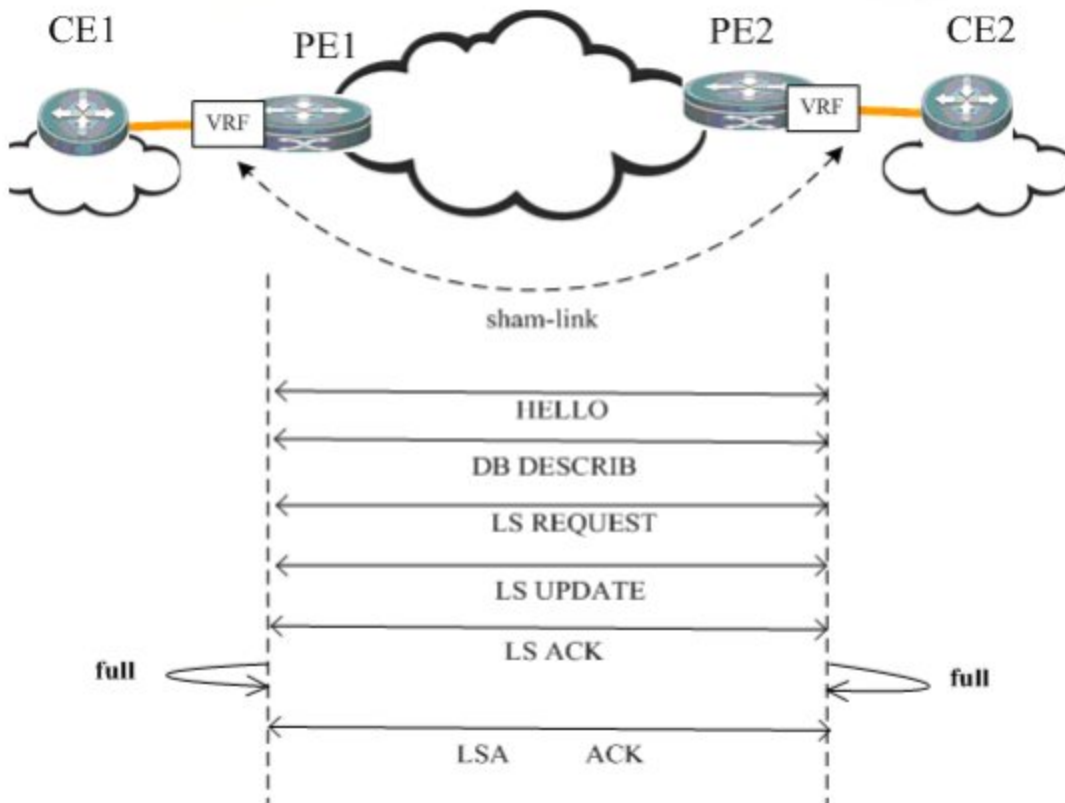

The purpose of establishing sham-link between VRF OSPF instances on different PEs include:

- ❖ The approach of using MP-IBGP to carry private-network route will only propagate the route, and the restoration work after reaching the peer PE is only to introduce the original OSPF routing information as far as possible, during which the OSPF topology information cannot be truly communicated. By establishing an OSPF link through sham-link, all OSPF instances inside each site can be truly connected and work out all-round topology information.
- ❖ Different sites in the same VPN exchanges information via MPLS backbone network, but a link is established between VPN sites so that VPN sites can still communicate via this link when MPLS backbone network fails. This link is called the "backdoor link". If two sites of VPN user fall into the same OSPF area and there is a "backdoor link" connecting these two sites, then routes will be exchanged via both MPLS backbone network and the "backdoor link". Since the routes exchanged via MPLS backbone network are inter-area routes and the routes exchanged via the "backdoor link" are intra-area routes, and the intra-area routes are apparently superior to inter-area routes, the route forwarding between two sites will hence use the backdoor link. This goes against the purpose of establishing "backdoor link". Therefore, the sham link shall be used in such applications.

Protocol specification

- ❖ RFC4576 and RFC4577 describe the mechanism to realize L3VPN OSPF.

3.2.6.2 Default configurations

Function	Default setting
domain-tag	AS ID local BGP
domain-id	Default value: NULL; default type: 0x0005
capability vrf-lite	By default, PE-CE OSPF feature is supported by VRF OSPF instance
extcommunity-type { router-id { 0107 8001 } route-type { 0306 8000 } }	In the OSPF instance Extended Communities attribute carried by BGP: the default type of route-id is 0x0107, and the default type of route-type is 0x0306.

3.2.6.3 Configure domain ID (optional)

Domain ID is used to indicate the domain to which the OSPF instance belongs. Generally, all VRF OSPF instances belonging to the same VPN shall be configured to the same domain ID. The configuration steps are shown below:

Command	Function
Qtech# configure terminal	Enter global configuration mode
Qtech(config)# router ospf <i>ospf-id</i> vrf <i>vrf-name</i>	Create OSPF instance and enter OSPF configuration mode
Qtech(config-router)# domain-id [ip-address [secondary] null type { 0005 0105 0205 8005 } value <i>hex-value</i> [secondary]]	(Optional) Configure the domain ID of OSPF instance. The OSPF domain ID is NULL by default.
Qtech(config-router)# show running-config	Display existing configurations.



Note

This command is only applicable to OSPF instance associated with VRF.

VRF OSPF instance can be configured with multiple domain IDs, but there is only one primary domain ID. Others are secondary domain IDs. The only primary domain ID is configured with "domain-id value" command, while multiple secondary domain IDs are configured with "domain-id value secondary" command. OSPF routes are advertised when converted to VPN routes, and VPN routes only contain the primary domain ID.

You can use the domain-id ip-address command or the domain-id type {0005|0105|0205|8005} value command to configure the primary and secondary domain IDs.

Different VRF OSPF instances can have the same domain ID. However, VRF OSPF instances in the same VPN must be configured with the same domain ID in order to guarantee the correctness of route advertisement.

Configure the primary domain ID and secondary domain ID of VRF OSPF protocol to 4.4.4.4 and 5.5.5.5 respectively.

```
Qtech# configure terminal
Qtech(config)# router ospf 10 vrf vrf1
Qtech(config router)# domain id 4.4.4.4
Qtech(config router)# domain id 5.5.5.5 secondary
Qtech(config router)# domain id type 0005 value 0101010101 secondary
```

3.2.6.4 Configure VPN route tag (optional)

Command	Function
Qtech# configure terminal	Enter global configuration mode
Qtech(config)# router ospf <i>ospf-id</i> vrf <i>vrf-name</i>	Create OSPF instance and enter OSPF configuration mode
Qtech (config-router)# domain-tag <i>value</i>	(Optional) Configure VPN route tag (1-4294967295) for OSPF instance.
Qtech(config-router)# show running-config	Display existing configurations



Note

This command is only applicable to OSPF instance associated with VRF.

If the domain-tag of VRF is not configured manually, then the default value is the AS number of local BGP protocol. In L3VPN, if one VPN site is connected with multiple PEs, then the VPN route learned by PE through MP-BGP will be advertised to VPN site in type-5 or type-7 LSA. Such route may also be learned by other PEs connecting to this VPN site and then advertised, hence causing loop. To avoid such loop, the same VPN route tag must be configured on PE for VRF OSPF instances connecting to the same VPN site. When VRF OSPF instance sends type-4 or type-7 LSAs to the VPN site, this LSA will also carry the VPN route tag. When other PEs receive such type-5 or type-7 LSA containing the VPN route tag, if such route tag is the same as the route tag of corresponding OSPF instance, this LSA won't participate in OSPF computation. Generally, OSPF instances associated with the same VPN must be configured with the same VPN route tag.

Configure the domain-tag of VRF OSPF protocol to 10.

```
Qtech# configure terminal
Qtech(config)# router ospf 10 vrf vrf1
Qtech(config router)# domain tag 10
```

3.2.6.5 Configure sham-link (optional)

Sham-link is mainly used in the scenario where there is a backdoor link between VPN sites. If you still expect to transmit VPN data via the MPLS backbone network, then you can establish sham-link between the VRF OSPF instances of two PEs. Both instances can establish OSPF neighbor through this sham-link and distribute LSA packets over the sham-link.

Command	Function
Qtech# configure terminal	Enter global configuration mode
Qtech(config)# router ospf <i>ospf-id</i> vrf <i>vrf-name</i>	Create OSPF instance and enter OSPF configuration mode

Qtech(config-router)# area area-id sham-link <i>source-address destination-address [cost number]</i> [dead-interval seconds] [hello-interval seconds] [retransmit-interval seconds] [transmit-delay seconds] [authentication [message-digest null]] [[authentication-key [0 7] key] [message-digest-key key-id md5 [0 7] key]]	Configure the area ID, source address and destination address of sham-link
Qtech(config-router)# show running-config	Display existing configurations



Note The sham-link must be configured on two PEs intending to establish the sham-link, which won't be established if only one PE is configured.

The following conditions must be met in order to establish the sham-link between two PEs:

- 1.The area-id of the sham-link configured on two PEs must be identical;
- 2.The <source address, destination address> of sham-link configured on one PE must correspond to the <source address, destination address> of sham-link configured on another PE;
- 3.The source address and destination address used to establish sham-link on the PE must be 32-bit Loopback address bound to VRF;

Because OSPF routes advertised by a sham link do not carry VPN labels, the routes cannot be used to forward packets. Packets are forwarded through BGP VPNv4 routes. Therefore, packets are forwarded through routes advertised by both a sham link and BGP neighbors.



Caution The source address for a sham link is advertised in BGP VPNv4 routes, but not calculated in OSPF instances.

Configure sham-link for VRF OSPF instance, with area ID being 0, source address being 1.1.1.1 and destination address being 2.2.2.2.

```
Qtech# configure terminal
Qtech(config)# router ospf 10 vrf vrf1
Qtech(config router)# area 0 sham link 1.1.1.1 2.2.2.2
```

3.2.6.6 Configure capability vrf-lite (optional)

The PE-CE OSPF feature of VRF OSPF instance involves LSA conversion as per domain ID, DN bit and VPN route tag. In certain circumstances, if you don't want VRF OSPF instance to support PE-CE OSPF feature, you can execute "**capability vrf-lite**" command to disable the feature.

Command	Function
Qtech# configure terminal	Enter global configuration mode
Qtech(config)# router ospf <i>ospf-id vrf</i> vrf-name	Create OSPF instance and enter OSPF configuration mode
Qtech(config-router)# capability vrf-lite	(Optional) Disable PE-CE OSPF feature of VRF OSPF instance

Qtech(config-router)# show running-config	Display existing configurations
--	---------------------------------



Note

This command is only applicable to OSPF instance associated with VRF.

In certain circumstances, you may expect to disable the loop check function of VRF OSPF instance. For example: VPN user uses MCE device to exchange VPN routes with PE. If MCE and PE exchanges VPN routes via OSPF protocol, to allow the VPN site to learn the routes of other VPN sites, you must execute "capability vrf-lite" command on MCE device to disable the loop check function of VRF OSPF instance.

Disable loop check function of VRF OSPF instance

```
Qtech# configure terminal
Qtech(config)# router ospf 10 vrf vrf1
Qtech(config-router)# capability vrf-lite
```

3.2.6.7 Configure extcommunity-type (optional)

While form VPN route for BGP, OSPF route redistribution will also carry the Extended Communities attribute of OSPF route, including router-id and route-type. By default, the type of Extended Communities attribute of router-id is 0x0107, and that of route-type is 0x0306. However, the user can manually configure the Extended Communities attribute of "router-id" and "route-type".

Command	Function
Qtech# configure terminal	Enter global configuration mode
Qtech(config)# router ospf ospf-id vrf vrf-name	Create OSPF instance and enter OSPF configuration mode
Qtech(config-router)# extcommunity-type { router-id { 0107 8001 } route-type { 0306 8000 } }	(Optional) Configure the Extended Communities attribute of OSPF router-id and route-type.
Qtech(config-router)# show running-config	Display existing configurations

- This command is only applicable to OSPF instance associated with VRF. The type configuration of router-id provides good compatibility with multiple manufacturers. For example, some manufacturers only support the router-id type of 0x0107. When interconnecting with such manufacturers, you must execute "extcommunity-type" command to set the type of router-id to 0x0107. The type configuration of route-type provides good compatibility with multiple manufacturers. For example, some manufacturers only support the route-type type of 0x8000. When interconnecting with such manufacturers, you must execute "extcommunity-type" command to set the type of route-type to 0x8000.

Configure the type of router-id of VRF OSPF protocol to 0x0107

```
Qtech# configure terminal
Qtech(config)# router ospf 10 vrf vrf1
Qtech(config-router)# extcommunity-type router-id 0107
```

3.3 Verification

This section describes how to verify the L3VPN configurations and VPN routes. Enter the privilege mode and run the following commands.

Command	Function
Qtech# show ip vrf [<i>vrf_name</i>]	Display the VRF configuration information.
Qtech# show bgp vpnv4 unicast all [<i>network</i> neighbor [<i>peer-address</i>] summary label]	Display the VPN routing information.
Qtech# show ip route vrf <i>vrf_name</i> [<i>ip-address</i> bgp connected isis ospf rip static]	Display the information about the VRF forwarding table.

Display the VPN routing information.

```
Qtech# show bgp vpnv4 unicast all
Network          Nexthop          Metric  Localprf          Path
Route Distinguisher : 100:2
*>i 192.168.0.1/32 192.168.0.2 0      100    10 ?
*>i 192.168.1.0/32 192.168.0.2 0      100    ?
Route Distinguisher : 100:30
*>i 192.168.0.1/32 192.168.0.2 0      100    10 ?
*> 192.168.4.0 192.168.4.1 0          20 ?
* 192.168.4.0 0.0.0.0 0      32768  ?
```

Field	Description
*	Indicates a valid route.
s (lower-case)	Indicates that the route is suppressed by an aggregated route.
S (upper-case)	Indicates that the route is a stale entry.
>	Indicates that the route is an optimal one.
I	Indicates that the route is learnt from the IBGP.
Nexthop	Indicates the next hop information of the route.
Metric	Indicates the route metric.
Localprf	Indicates the local preference of the route.
Path	Indicates the AS path included in the route.
I	Indicates that the origin of the route is IGP.
E	Indicates that the origin of the route is EGP.
?	Indicates that the origin of the route is another attribute except IGP or EGP (for example, a redistributed BGP route).

Display the information about the VRF routing table.

```
Qtech# show ip route vrf vrf1
Codes: C    connected, S    static, R    RIP,B    BGP
O    OSPF, IA    OSPF inter area
N1   OSPF NSSA external type 1, N2   OSPF NSSA external type 2
E1   OSPF external type 1, E2   OSPF external type 2
i    IS IS, L1   IS IS level 1, L2   IS IS level 2 , ia   IS IS inter area
```

```
* candidate default
B 192.168.0.1/32 , [200/0] via 192.168.0.2, 01:02:33
B 192.168.0.3/32 , [200/0] via 192.168.4.1 , 01:02:33
C 192.168.4.0/24 is directly connected ,eth1
```

Display the VRF configuration information.

```
Qtch# show ip vrf vrf1
VRF vrf1; default RD : 100: 2
Interfaces:
Eth0
Export VPN route target communities:
RT : 100: 30
No import VPN route target community
No import route map
```

3.4 Configuration Examples

3.4.1 Intranet Configuration Example

Networking Requirements

There are two VPN users: VPNA and VPNB. VPNA has sites in SITEA, SITEB, and SITEC and VPNB has sites in SITEB and SITEC. It is now required that the users in different sites of VPNA access each other, the users in different sites of VPNB access each other, and the users in the two VPNs not access each other, as shown in the following figure.

Figure 24

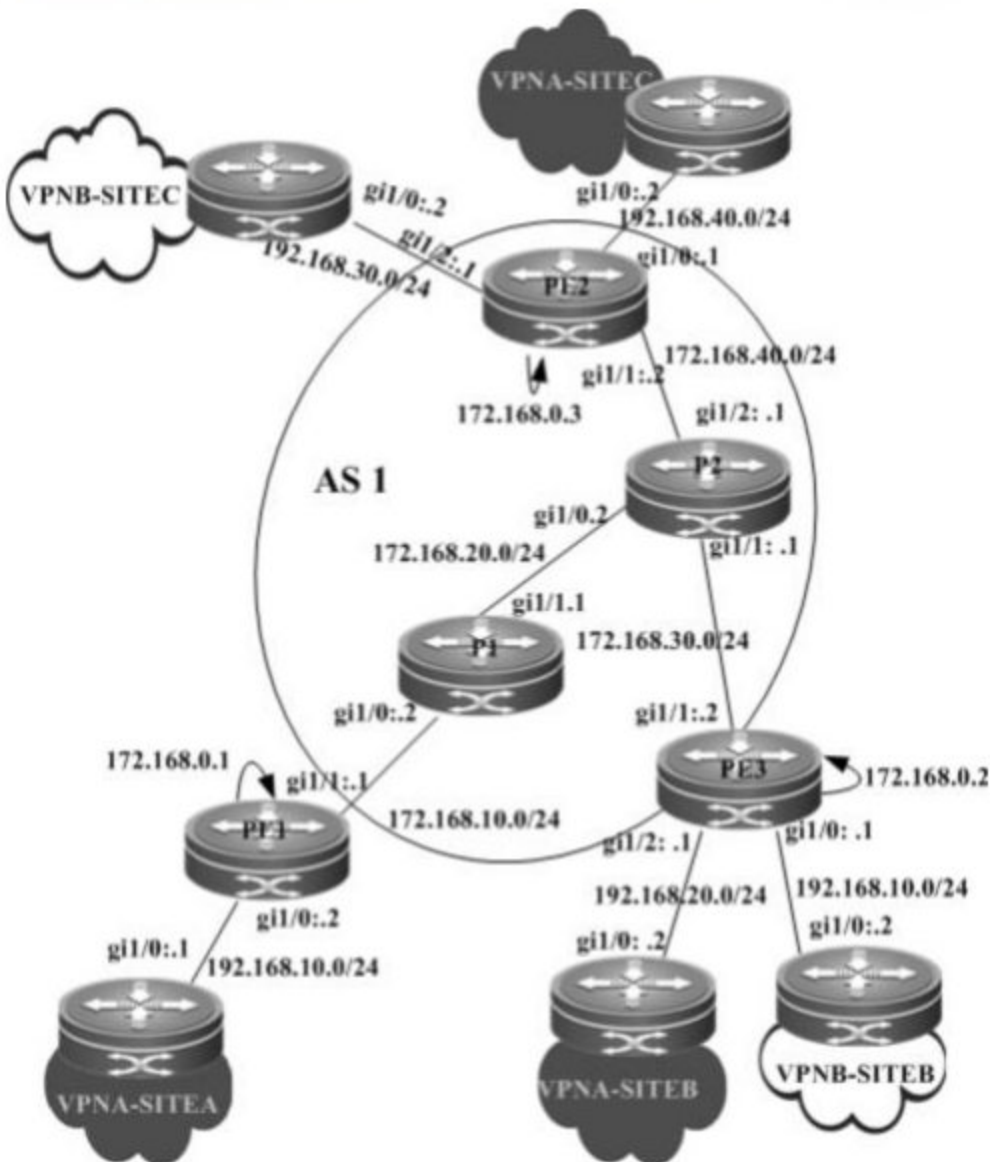

Configuration Steps

PE1:

Configure the loopback interface.

```
Qtech# configure terminal
Qtech(config)# interface loopback 0
Qtech(config-if-Loopback 0)# ip address 172.168.0.1 255.255.255.255
```

Configure the VRF.

Create one VRF instance: VPNA . Set the RD and RT values, and associate the VRF with the corresponding interface.

```
Qtech# configure terminal
```

```
Qtech(config)# ip vrf VPNA
Qtech(config vrf)# rd 1:100
Qtech(config vrf)# route target both 1:100
Qtech(config vrf)# end
```

Associate the VRF with an interface.

```
Qtech# configure terminal
Qtech(config)# interface gigabitethernet 1/0
```

Use the `no switchport` command to switch the port mode on the switch series to the Routed Port mode. This command is not applicable to routers.

```
Qtech(config if GigabitEthernet 1/0)# no switchport
```

Enable MPLS fast forwarding on a router. This command is unnecessary on a switch.

```
Qtech(config if GigabitEthernet 1/0)# ip ref
Qtech(config if GigabitEthernet 1/0)# ip vrf forwarding VPNA
Qtech(config if GigabitEthernet 1/0)# ip address 192.168.10.2 255.255.255.0
Qtech(config if GigabitEthernet 1/0)# end
```

Enable BGP and set up MP-IBGP sessions with PE2 and PE3.

```
Qtech# configure terminal
Qtech(config)# router bgp 1
Qtech(config router)# neighbor 172.168.0.2 remote as 1
Qtech(config router)# neighbor 172.168.0.2 update source loopback 0
Qtech(config router)# neighbor 172.168.0.3 remote as 1
Qtech(config router)# neighbor 172.168.0.3 update source loopback 0
Qtech(config router)# address family vpnv4
Qtech(config router af)# neighbor 172.168.0.2 activate
Qtech(config router af)# neighbor 172.168.0.3 activate
Qtech(config router af)# end
```

Configure CE neighbors through EBGP.

```
Qtech# configure terminal
Qtech(config)# router bgp 1
Qtech(config)# address family ipv4 vrf VPNA
Qtech(config router af)# neighbor 172.168.10.1 remote as 65002
Qtech(config router af)# end
```

Configure the MPLS signaling on the backbone network and enable MPLS on the public network interface.

```
Qtech# configure terminal
Qtech(config)# mpls ip
Qtech(config)# mpls router ldp
Qtech(config mpls router)# ldp router id interface loopback 0 force
Qtech(config mpls router)# exit
Qtech(config)# interface gigabitethernet 1/1
```

Use the **no switchport** command to switch the port mode on the switch series to the Routed Port mode. This command is not applicable to routers.

```
Qtech(config if GigabitEthernet 1/1)# no switchport
# Enable MPLS fast forwarding on a router. This command is unnecessary on a switch.
Qtech(config if GigabitEthernet 1/1)# ip ref
Qtech(config if GigabitEthernet 1/1)# ip address 172.168.10.1 255.255.255.0
Qtech(config if GigabitEthernet 1/1)# label switching
Qtech(config if GigabitEthernet 1/1)# mpls ip
Qtech(config if GigabitEthernet 1/1)# end
```

Configure routing protocols on the backbone network.

```
Qtech# configure terminal
Qtech(config)# router ospf 10
Qtech(config router)# network 172.168.10.0 0.0.0.255 area 0
Qtech(config router)# network 172.168.0.1 0.0.0.0 area 0
Qtech(config router)# end
```

PE2:

Configure the loopback interface.

```
Qtech# configure terminal
Qtech(config)# interface loopback 0
Qtech(config if Loopback 0)# ip address 172.168.0.3 255.255.255.255
```

Configure the VRF.

Create two VRFs: VPNA and VPNB. Set the RD and RT values, and associate the VRFs with their corresponding interfaces.

```
Qtech# configure terminal
Qtech(config)# ip vrf VPNA
Qtech(config vrf)# rd 1:100
Qtech(config vrf)# route target both 1:100
Qtech(config vrf)# exit
Qtech(config)# ip vrf VPNB
Qtech(config vrf)# rd 1:200
Qtech(config vrf)# route target both 1:200
Qtech(config vrf)# exit
```

Associate the VRF with an interface.

```
Qtech# configure terminal
Qtech(config)# interface gigabitethernet 1/0
```

Use the **no switchport** command to switch the port mode on the switch series to the Routed Port mode. This command is not applicable to routers.

```
Qtech(config if GigabitEthernet 1/0)# no switchport
```

Enable MPLS fast forwarding on a router. This command is unnecessary on a switch.

```
Qtech(config if GigabitEthernet 1/0)# ip ref
Qtech(config if GigabitEthernet 1/0)# ip vrf forwarding VPNB
Qtech(config if GigabitEthernet 1/0)# ip address 192.168.10.1 255.255.255.0
Qtech(config if GigabitEthernet 1/0)# exit
Qtech(config)# interface gigabitethernet 1/1
```

Use the **no switchport** command to switch the port mode on the switch series to the Routed Port mode. This command is not applicable to routers.

```
Qtech(config if GigabitEthernet 1/1)# no switchport
```

Enable MPLS fast forwarding on a router. This command is unnecessary on a switch.

```
Qtech(config if GigabitEthernet 1/1)# ip ref
Qtech(config if GigabitEthernet 1/1)# ip vrf forwarding VPNA
Qtech(config if GigabitEthernet 1/1)# ip address 192.168.20.1
255.255.255.0
Qtech(config if GigabitEthernet 1/1)# exit
```

Enable BGP and set up MP-IBGP sessions with PE2 and PE3.

```
Qtech# configure terminal
Qtech(config)# router bgp 1
Qtech(config router)# neighbor 172.168.0.1 remote as 1
Qtech(config router)# neighbor 172.168.0.1 update source loopback 0
Qtech(config router)# neighbor 172.168.0.3 remote as 1
Qtech(config router)# neighbor 172.168.0.3 update source loopback 0
Qtech(config router)# address family vpnv4
Qtech(config router af)# neighbor 172.168.0.1 activate
Qtech(config router af)# neighbor 172.168.0.3 activate
Qtech(config router af)# end
```

Configure CE neighbors through EBGP.

```
Qtech# configure terminal
Qtech(config)# router bgp 1
Qtech(config)# address family ipv4 vrf VPNA
Qtech(config router af)# neighbor 172.168.20.2 remote as 65003
Qtech(config router af)# exit
Qtech(config)# address family ipv4 vrf VPNB
Qtech(config router af)# neighbor 172.168.10.2 remote as 65004
Qtech(config router af)# end
```

Configure the MPLS signaling on the backbone network and enable MPLS on the public network interface.

```
Qtech# configure terminal
Qtech(config)# mpls ip
Qtech(config)# mpls router ldp
```



```
Qtech(config mpls router)# ldp router id interface loopback 0 force
Qtech(config mpls router)# exit
Qtech(config)# interface gigabitethernet 1/1
```

Use the **no switchport** command to switch the port mode on the switch series to the Routed Port mode. This command is not applicable to routers.

```
Qtech(config if GigabitEthernet 1/1)# no switchport
```

Enable MPLS fast forwarding on a router. This command is unnecessary on a switch.

```
Qtech(config if GigabitEthernet 1/1)# ip ref
Qtech(config if GigabitEthernet 1/1)# ip address 172.168.30.2 255.255.255.0
Qtech(config if GigabitEthernet 1/1)# label switching
Qtech(config if GigabitEthernet 1/1)# mpls ip
Qtech(config if GigabitEthernet 1/1)# end
```

Configure routing protocols on the backbone network.

```
Qtech# configure terminal
Qtech(config)# router ospf 10
Qtech(config router)# network 172.168.30.0 255.255.255.0 area 0
Qtech(config router)# network 172.168.0.2 255.255.255.255 area 0
Qtech(config router)# end
```

PE3:

The configuration procedure is similar to that of PE2.

VPNA-SITEA:

Set up an EBGP session with PE1.

```
Qtech# configure terminal
Qtech(config)# router bgp 65002
Qtech(config router)# neighbor 172.168.10.2 remote as 1
Qtech(config router af)# end
```

VPNA-SITEB:

The configuration procedure is similar to that of VPNA-SITEA.

VPNA-SITEC:

The configuration procedure is similar to that of VPNA-SITEA.

VPNB-SITEB:

The configuration procedure is similar to that of VPNA-SITEA.

VPNB-SITEC:

The configuration procedure is similar to that of VPNA-SITEA.

P1:

Configure the loopback interface.

```
Qtech# configure terminal
Qtech(config)# interface loopback 0
Qtech(config-if Loopback 0)# ip address 172.168.0.5 255.255.255.255
```

Configure the MPLS signaling on the backbone network and enable MPLS on the public network interface.

```
Qtech# configure terminal
Qtech(config)# mpls ip
Qtech(config)# mpls router ldp
Qtech(config-mpls-router)# ldp router id interface loopback 0 force
Qtech(config-mpls-router)# exit
Qtech(config)# interface gigabitethernet 1/0
```

Use the **no switchport** command to switch the port mode on the switch series to the Routed Port mode. This command is not applicable to routers.

```
Qtech(config-if GigabitEthernet 1/0)# no switchport
```

Enable MPLS fast forwarding on a router. This command is unnecessary on a switch.

```
Qtech(config-if GigabitEthernet 1/0)# ip ref
Qtech(config-if GigabitEthernet 1/0)# ip address 172.168.10.2 255.255.255.0
Qtech(config-if GigabitEthernet 1/0)# label switching
Qtech(config-if GigabitEthernet 1/0)# mpls ip
Qtech(config-if GigabitEthernet 1/0)# exit
Qtech(config)# interface gigabitethernet 1/1
```

Use the **no switchport** command to switch the port mode on the switch series to the Routed Port mode. This command is not applicable to routers.

```
Qtech(config-if GigabitEthernet 1/1)# no switchport
```

Enable MPLS fast forwarding on a router. This command is unnecessary on a switch.

```
Qtech(config-if GigabitEthernet 1/1)# ip ref
Qtech(config-if GigabitEthernet 1/1)# ip address 172.168.20.1 255.255.255.0
Qtech(config-if GigabitEthernet 1/1)# label switching
Qtech(config-if GigabitEthernet 1/1)# mpls ip
Qtech(config-if GigabitEthernet 1/0)# end
```

Configure routing protocols on the backbone network.

```
Qtech# configure terminal
Qtech(config)# router ospf 10
Qtech(config-router)# network 172.168.10.0 0.0.0.255 area 0
Qtech(config-router)# network 172.168.20.0 0.0.0.255 area 0
Qtech(config-router)# end
```

P2:

The configuration procedure is similar to that of P1.

3.4.2 Extranet Configuration Example

Networking Requirements

There are two VPN users: VPNA and VPNB. Mutual access is required in a VPN. The two VPNs cannot access each other but can access some shared resources. As shown in the following figure, VPNA and VPNB sites should access the resources of VPN-SITEA.

Figure 25

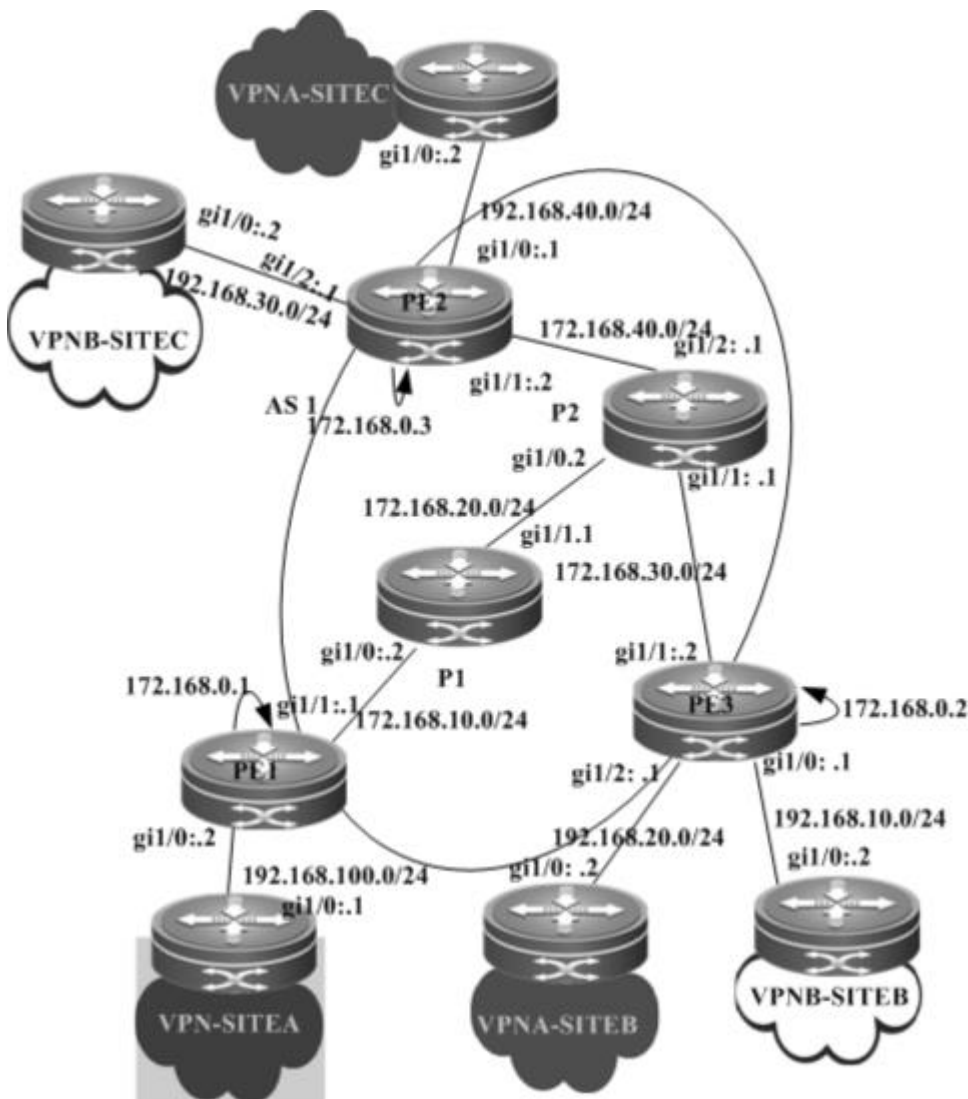

Configuration procedure:

PE1:

Configure the loopback interface.

```
Qtech# configure terminal
Qtech(config)# interface loopback 0
Qtech(config if Loopback 0)# ip address 172.168.0.1 255.255.255.255
```

Configure the VRF.

Create one VRF instance: VPN_EXTRA. Set the RD and RT values, and associate the VRF with the corresponding interface.

```
Qtech# configure terminal
Qtech(config)# ip vrf VPN_EXTRA
Qtech(config vrf)# rd 1:100
Qtech(config vrf)# route target both 1:100
Qtech(config vrf)# route target both 1:200
Qtech(config vrf)# end
```

Associate the VRF with an interface.

```
Qtech# configure terminal
Qtech(config)# interface gigabitethernet 1/0
```

Use the **no switchport** command to switch the port mode on the switch series to the Routed Port mode. This command is not applicable to routers.

```
Qtech(config if GigabitEthernet 1/0)# no switchport
```

Enable MPLS fast forwarding on a router. This command is unnecessary on a switch.

```
Qtech(config if GigabitEthernet 1/0)# ip ref
Qtech(config if GigabitEthernet 1/0)# ip vrf forwarding VPN_EXTRA
Qtech(config if GigabitEthernet 1/0)# ip address 192.168.100.2 255.255.255.0
Qtech(config if GigabitEthernet 1/0)# end
```

Enable BGP and set up MP-IBGP sessions with PE2 and PE3.

```
Qtech# configure terminal
Qtech(config)# router bgp 1
Qtech(config router)# neighbor 172.168.0.2 remote as 1
Qtech(config router)# neighbor 172.168.0.2 update source loopback 0
Qtech(config router)# neighbor 172.168.0.3 remote as 1
Qtech(config router)# neighbor 172.168.0.3 update source loopback 0
Qtech(config router)# address family vpnv4
Qtech(config router af)# neighbor 172.168.0.2 activate
Qtech(config router af)# neighbor 172.168.0.3 activate
Qtech(config router af)# end
```

Enable OSPF to exchange routes with a CE.

```
Qtech# configure terminal
Qtech(config)# router ospf 10 vrf VPN_EXTRA
Qtech(config router)# network 192.168.100.0 255.255.255.0 area 0
Qtech(config router)# redistribute bgp subnets
```

```
Qtech(config router)# exit
Qtech(config)# router bgp 1
Qtech(config router)# address family ipv4 vrf VPN_EXTRA
Qtech(config router af)# redistribute ospf 10
Qtech(config router af)# end
```

Configure the MPLS signaling on the backbone network and enable MPLS on the public network interface.

```
Qtech# configure terminal
Qtech(config)# mpls ip
Qtech(config)# mpls router ldp
Qtech(config mpls router)# ldp router id interface loopback 0 force
Qtech(config mpls router)# exit
Qtech(config)# interface gigabitethernet 1/1
```

Use the `no switchport` command to switch the port mode on the switch series to the Routed Port mode. This command is not applicable to routers.

```
Qtech(config if GigabitEthernet 1/1)# no switchport
```

Enable MPLS fast forwarding on a router. This command is unnecessary on a switch.

```
Qtech(config if GigabitEthernet 1/1)# ip ref
Qtech(config if GigabitEthernet 1/1)# ip address 172.168.10.1 255.255.255.0
Qtech(config if GigabitEthernet 1/1)# label switching
Qtech(config if GigabitEthernet 1/1)# mpls ip
Qtech(config if GigabitEthernet 1/1)# end
```

Configure routing protocols on the backbone network.

```
Qtech# configure terminal
Qtech(config)# router ospf 1
Qtech(config router)# network 172.168.10.0 0.0.0.255 area 0
Qtech(config router)# network 172.168.0.1 0.0.0.0 area 0
Qtech(config router)# end
```

PE2:

Configure the loopback interface.

```
Qtech# configure terminal
Qtech(config)# interface loopback 0
Qtech(config if Loopback 0)# ip address 172.168.0.3 255.255.255.255
```

Configure the VRF.

Create two VRF instances: VPNA and VPNB. Set the RD and RT values, and associate the VRFs with their corresponding interfaces.

```
Qtech# configure terminal
Qtech(config)# ip vrf VPNA
Qtech(config vrf)# rd 1:100
```

```
Qtech(config vrf)# route target both 1:100
Qtech(config vrf)# exit
Qtech(config)# ip vrf VPNB
Qtech(config vrf)# rd 1:200
Qtech(config vrf)# route target both 1:200
Qtech(config vrf)# exit
```

Associate the VRF with an interface.

```
Qtech# configure terminal
Qtech(config)# interface gigabitethernet 1/0
```

Use the **no switchport** command to switch the port mode on the switch series to the Routed Port mode. This command is not applicable to routers.

```
Qtech(config if GigabitEthernet 1/0)# no switchport
```

Enable MPLS fast forwarding on a router. This command is unnecessary on a switch.

```
Qtech(config if GigabitEthernet 1/0)# ip ref
Qtech(config if GigabitEthernet 1/0)# ip vrf forwarding VPNB
Qtech(config if GigabitEthernet 1/0)# ip address 192.168.10.1
255.255.255.0
Qtech(config if GigabitEthernet 1/0)# exit
Qtech(config)# interface gigabitethernet 1/1
```

Use the **no switchport** command to switch the port mode on the switch series to the Routed Port mode. This command is not applicable to routers.

```
Qtech(config if GigabitEthernet 1/1)# no switchport
```

Enable MPLS fast forwarding on a router. This command is unnecessary on a switch.

```
Qtech(config if GigabitEthernet 1/1)# ip ref
Qtech(config if GigabitEthernet 1/1)# ip vrf forwarding VPNA
Qtech(config if GigabitEthernet 1/1)# ip address 192.168.20.1
255.255.255.0
Qtech(config if GigabitEthernet 1/1)# exit
```

Enable BGP and set up MP-IBGP sessions with PE2 and PE3.

```
Qtech# configure terminal
Qtech(config)# router bgp 1
Qtech(config router)# neighbor 172.168.0.1 remote as 1
Qtech(config router)# neighbor 172.168.0.1 update source loopback 0
Qtech(config router)# neighbor 172.168.0.3 remote as 1
Qtech(config router)# neighbor 172.168.0.3 update source loopback 0
Qtech(config router)# address family vpnv4
Qtech(config router af)# neighbor 172.168.0.1 activate
Qtech(config router af)# neighbor 172.168.0.3 activate
Qtech(config router af)# end
```

Enable OSPF to exchange VPN routes with a CE.

```
Qtech# configure terminal
Qtech(config)# router ospf 10 vrf VPNA
Qtech(config router)# network 192.168.20.0 255.255.255.0 area 0
Qtech(config router)# redistribute bgp subnets
Qtech(config router)# exit
Qtech(config)# router ospf 20 vrf VPNB
Qtech(config router)# network 192.168.10.0 255.255.255.0 area 0
Qtech(config router)# redistribute bgp subnets
Qtech(config router)# exit
Qtech(config)# router bgp 1
Qtech(config router)# address family ipv4 vrf VPNA
Qtech(config router af)# redistribute ospf 10
Qtech(config router af)# exit
Qtech(config router)# address family ipv4 vrf VPNB
Qtech(config router af)# redistribute ospf 20
Qtech(config router af)# exit
```

Configure the MPLS signaling on the backbone network and enable MPLS on the public network interface.

```
Qtech# configure terminal
Qtech(config)# mpls ip
Qtech(config)# mpls router ldp
Qtech(config mpls router)# ldp router id interface loopback 0 force
Qtech(config mpls router)# exit
Qtech(config)# interface gigabitethernet 1/1
```

Use the `no switchport` command to switch the port mode on the switch series to the Routed Port mode. This command is not applicable to routers.

```
Qtech(config if GigabitEthernet 1/1)# no switchport
```

Enable MPLS fast forwarding on a router. This command is unnecessary on a switch.

```
Qtech(config if GigabitEthernet 1/1)# ip ref
Qtech(config if GigabitEthernet 1/1)# ip address 172.168.30.2 255.255.255.0
Qtech(config if GigabitEthernet 1/1)# label switching
Qtech(config if GigabitEthernet 1/1)# mpls ip
Qtech(config if GigabitEthernet 1/1)# end
```

Configure routing protocols on the backbone network.

```
Qtech# configure terminal
Qtech(config)# router ospf 1
Qtech(config router)# network 172.168.30.0 0.0.0.255 area 0
Qtech(config router)# network 172.168.0.2 0.0.0.0 area 0
Qtech(config router)# end
```

PE3:

The configuration procedure is similar to that of PE2.

VPNA-SITEA:

```
Qtech# configure terminal
Qtech(config)# router ospf 10
Qtech(config router)# network 192.168.100.0 255.255.255.0 area 0
Qtech(config router)# end
```

VPNA-SITEB:

The configuration procedure is similar to that of VPNA-SITEA.

VPNA-SITEC:

The configuration procedure is similar to that of VPNA-SITEA.

VPNB-SITEB:

The configuration procedure is similar to that of VPNA-SITEA.

VPNB-SITEC:

The configuration procedure is similar to that of VPNA-SITEA.

P1:

Configure the loopback interface.

```
Qtech# configure terminal
Qtech(config)# interface loopback 0
Qtech(config if Loopback 0)# ip address 172.168.0.5 255.255.255.255
```

Configure the MPLS signaling on the backbone network and enable MPLS on the public network interface.

```
Qtech# configure terminal
Qtech(config)# mpls ip
Qtech(config)# mpls router ldp
Qtech(config mpls router)# ldp router id interface loopback 0 force
Qtech(config mpls router)# exit
Qtech(config)# interface gigabitethernet 1/0
```

Use the **no switchport** command to switch the port mode on the switch series to the Routed Port mode. This command is not applicable to routers.

```
Qtech(config if GigabitEthernet 1/0)# no switchport
```

Enable MPLS fast forwarding on a router. This command is unnecessary on a switch.

```
Qtech(config if GigabitEthernet 1/0)# ip ref
Qtech(config if GigabitEthernet 1/0)# ip address 172.168.10.2 255.255.255.0
Qtech(config if GigabitEthernet 1/0)# label switching
```



```
Qtech(config if GigabitEthernet 1/0)# mpls ip
Qtech(config if GigabitEthernet 1/0)# exit
Qtech(config)# interface gigabitethernet 1/1
```

Use the **no switchport** command to switch the port mode on the switch series to the Routed Port mode. This command is not applicable to routers.

```
Qtech(config if GigabitEthernet 1/1)# no switchport
```

Enable MPLS fast forwarding on a router. This command is unnecessary on a switch.

```
Qtech(config if GigabitEthernet 1/1)# ip ref
Qtech(config if GigabitEthernet 1/1)# ip address 172.168.20.1 255.255.255.0
Qtech(config if GigabitEthernet 1/1)# label switching
Qtech(config if GigabitEthernet 1/1)# mpls ip
Qtech(config if GigabitEthernet 1/0)# end
```

Configure routing protocols on the backbone network.

```
Qtech# configure terminal
Qtech(config)# router ospf 1
Qtech(config router)# network 172.168.10.0 0.0.0.255 area 0
Qtech(config router)# network 172.168.20.0 0.0.0.255 area 0
Qtech(config router)# end
```

P2:

The configuration procedure is similar to that of P1.

For the protocol between PEs and CEs, you can choose EBGp, OSPF, RIP, or other routing protocol as required.

3.4.3 Configuration Example for Hub-and-Spoke

Requirement: The VPN internal data should not be directly exchanged. Instead, the data must be exchanged through the unified control center. Only the control center is entitled to access all resources of a VPN. Any VPN users who want to obtain the VPN resources, must be notified through the control center. As shown in the following figure, to access VPNA-SITEB resources, VPNA-SITEA must pass the control center VPNA-SITEC. Direct access is not available.

Figure 26

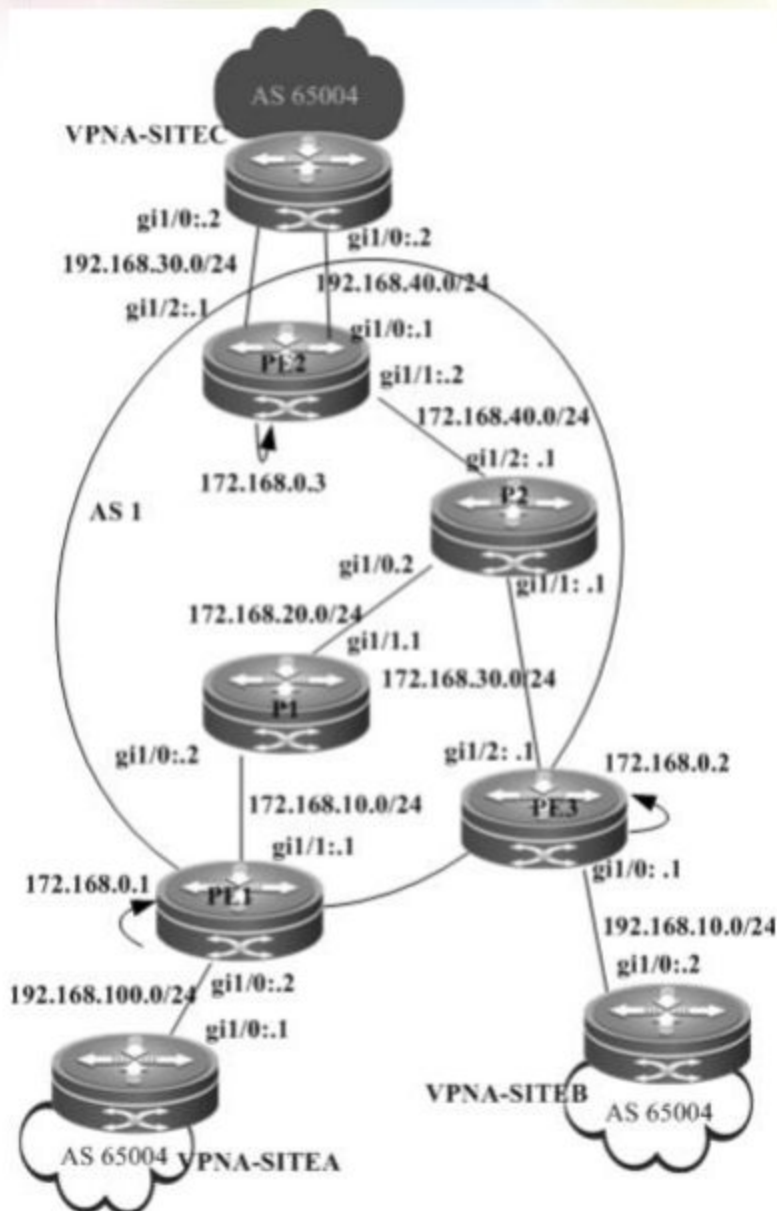

Configuration procedure:

PE1:

Configure the loopback interface.

```
Qtech# configure terminal
Qtech(config)# interface loopback 0
Qtech(config-if-Loopback 0)# ip address 172.168.0.1 255.255.255.255
```

Configure the VRF.

Create one VRF instance: spoke1. Set the RD and RT values, and associate the VPNA with the corresponding interface.

```
Qtech# configure terminal
Qtech(config)# ip vrf spoke1
```

```
Qtech(config vrf)# rd 1:100
Qtech(config vrf)# route target export 1:200
Qtech(config vrf)# route target import 1:100
Qtech(config vrf)# end
```

Associate the VRF with an interface.

```
Qtech# configure terminal
Qtech(config)# interface gigabitethernet 1/0
```

Use the `no switchport` command to switch the port mode on the switch series to the Routed Port mode. This command is not applicable to routers.

```
Qtech(config if GigabitEthernet 1/0)# no switchport
```

Enable MPLS fast forwarding on a router. This command is unnecessary on a switch.

```
Qtech(config if GigabitEthernet 1/0)# ip ref
Qtech(config if GigabitEthernet 1/0)# ip vrf forwarding spokel
Qtech(config if GigabitEthernet 1/0)# ip address 192.168.100.2 255.255.255.0
Qtech(config if GigabitEthernet 1/0)# end
```

Enable BGP and set up MP-IBGP sessions with PE3.

```
Qtech# configure terminal
Qtech(config)# router bgp 1
Qtech(config router)# neighbor 172.168.0.3 remote as 1
Qtech(config router)# neighbor 172.168.0.3 update source loopback 0
Qtech(config router)# address family vpnv4
Qtech(config router af)# neighbor 172.168.0.3 activate
Qtech(config router af)# neighbor 172.168.0.3 allowas in
Qtech(config router af)# end
```

Configure CE neighbors through EBGP.

```
Qtech# configure terminal
Qtech(config)# router bgp 1
Qtech(config)# address family ipv4 vrf spokel
Qtech(config router af)# neighbor 192.168.100.1 remote as 65004
Qtech(config router af)# neighbor 192.168.100.1 as override
Qtech(config router af)# end
```

Configure the MPLS signaling on the backbone network and enable MPLS on the public network interface.

```
Qtech# configure terminal
Qtech(config)# mpls ip
Qtech(config)# mpls router ldp
Qtech(config mpls router)# ldp router id interface loopback 0 force
Qtech(config mpls router)# exit
Qtech(config)# interface gigabitethernet 1/1
```

Use the **no switchport** command to switch the port mode on the switch series to the Routed Port mode. This command is not applicable to routers.

```
Qtech(config if GigabitEthernet 1/1)# no switchport
```

Enable MPLS fast forwarding on a router. This command is unnecessary on a switch.

```
Qtech(config if GigabitEthernet 1/1)# no switchport
Qtech(config if GigabitEthernet 1/1)# ip address 172.168.10.1 255.255.255.0
Qtech(config if GigabitEthernet 1/1)# label switching
Qtech(config if GigabitEthernet 1/1)# mpls ip
Qtech(config if GigabitEthernet 1/1)# end
```

Configure routing protocols on the backbone network.

```
Qtech# configure terminal
Qtech(config)# router ospf 10
Qtech(config router)# network 172.168.10.0 0.0.0.255 area 0
Qtech(config router)# network 172.168.0.1 0.0.0.0 area 0
Qtech(config router)# end
```

PE2:

Configure the loopback interface.

```
Qtech# configure terminal
Qtech(config)# interface loopback 0
Qtech(config if Loopback 0)# ip address 172.168.0.3 255.255.255.255
```

Configure the VRF.

Create one VRF instance: spoke2. Set the RD and RT values, and associate the VRF with the corresponding interface.

```
Qtech# configure terminal
Qtech(config)# ip vrf spoke2
Qtech(config vrf)# rd 1:100
Qtech(config vrf)# route target export 1:300
Qtech(config vrf)# route target import 1:100
Qtech(config vrf)# exit
```

Associate the VRF with an interface.

```
Qtech# configure terminal
Qtech(config)# interface gigabitethernet 1/0
```

Use the **no switchport** command to switch the port mode on the switch series to the Routed Port mode. This command is not applicable to routers.

```
Qtech(config if GigabitEthernet 1/0)# no switchport
```

Enable MPLS fast forwarding on a router. This command is unnecessary on a switch.

```
Qtech(config if GigabitEthernet 1/0)# no switchport
Qtech(config if GigabitEthernet 1/0)# ip vrf forwarding spoke2
Qtech(config if GigabitEthernet 1/0)# ip address 192.168.10.1
255.255.255.0
Qtech(config if GigabitEthernet 1/0)# exit
```

Enable BGP and set up MP-IBGP sessions with PE3.

```
Qtech# configure terminal
Qtech(config)# router bgp 1
Qtech(config router)# neighbor 172.168.0.3 remote as 1
Qtech(config router)# neighbor 172.168.0.3 update source loopback 0
Qtech(config router)# address family vpnv4
Qtech(config router af)# neighbor 172.168.0.3 activate
Qtech(config router af)# neighbor 172.168.0.3 allowas in
Qtech(config router af)# end
```

Configure CE neighbors through EBGP.

```
Qtech# configure terminal
Qtech(config)# router bgp 1
Qtech(config router)# address family ipv4 vrf spoke2
Qtech(config router af)# neighbor 192.168.10.2 remote as 65004
Qtech(config router af)# neighbor 192.168.10.2 as override
Qtech(config router af)# end
```

Configure the MPLS signaling on the backbone network and enable MPLS on the public network interface.

```
Qtech# configure terminal
Qtech(config)# mpls ip
Qtech(config)# mpls router ldp
Qtech(config mpls router)# ldp router id interface loopback 0 force
Qtech(config mpls router)# exit
Qtech(config)# interface gigabitethernet 1/1
```

Use the **no switchport** command to switch the port mode on the switch series to the Routed Port mode. This command is not applicable to routers.

```
Qtech(config if GigabitEthernet 1/1)# no switchport
```

Enable MPLS fast forwarding on a router. This command is unnecessary on a switch.

```
Qtech(config if GigabitEthernet 1/1)# no switchport
Qtech(config if GigabitEthernet 1/1)# ip address 172.168.30.2 255.255.255.0
Qtech(config if GigabitEthernet 1/1)# label switching
Qtech(config if GigabitEthernet 1/1)# mpls ip
Qtech(config if GigabitEthernet 1/1)# end
```

Configure routing protocols on the backbone network.

```
Qtech# configure terminal
Qtech(config)# router ospf 10
Qtech(config router)# network 172.168.30.0 0.0.0.255 area 0
Qtech(config router)# network 172.168.0.2 0.0.0.0 area 0
Qtech(config router)# end
```

PE3:

Configure the loopback interface.

```
Qtech# configure terminal
Qtech(config)# interface loopback 0
Qtech(config if Loopback 0)# ip address 172.168.0.2 255.255.255.255
```

Configure the VRF.

Create two VRF instances: from-spoke and from-hub. Set the RD and RT values, and associate the VRFs with their corresponding interfaces.

```
Qtech# configure terminal
Qtech(config)# ip vrf from spoke
Qtech(config vrf)# rd 1:100
Qtech(config vrf)# route target import 1:300
Qtech(config vrf)# route target import 1:200
Qtech(config vrf)# exit
Qtech(config)# ip vrf from hub
Qtech(config vrf)# rd 1:200
Qtech(config vrf)# route target export 1:100
Qtech(config vrf)# exit
```

Associate the VRF with an interface.

```
Qtech# configure terminal
Qtech(config)# interface gigabitethernet 1/0
```

Use the **no switchport** command to switch the port mode on the switch series to the Routed Port mode. This command is not applicable to routers.

```
Qtech(config if GigabitEthernet 1/0)# no switchport
```

Enable MPLS fast forwarding on a router. This command is unnecessary on a switch.

```
Qtech(config if GigabitEthernet 1/0)# no switchport
Qtech(config if GigabitEthernet 1/0)# ip vrf forwarding from hub
Qtech(config if GigabitEthernet 1/0)# ip address 192.168.40.1
255.255.255.0
Qtech(config if GigabitEthernet 1/0)# exit
Qtech(config)# interface gigabitethernet 1/1
```

Use the **no switchport** command to switch the port mode on the switch series to the Routed Port mode. This command is not applicable to routers.

```
Qtech(config if GigabitEthernet 1/1)# no switchport
```

Enable MPLS fast forwarding on a router. This command is unnecessary on a switch.

```
Qtech(config if GigabitEthernet 1/1)# no switchport
Qtech(config if GigabitEthernet 1/1)# ip vrf forwarding from spoke
Qtech(config if GigabitEthernet 1/1)# ip address 192.168.30.1
255.255.255.0
Qtech(config if GigabitEthernet 1/1)# exit
```

Enable BGP and set up MP-IBGP sessions with PE1 and PE2.

```
Qtech# configure terminal
Qtech(config)# router bgp 1
Qtech(config router)# neighbor 172.168.0.1 remote as 1
Qtech(config router)# neighbor 172.168.0.1 update source loopback 0
Qtech(config router)# neighbor 172.168.0.2 remote as 1
Qtech(config router)# neighbor 172.168.0.2 update source loopback 0
Qtech(config router)# address family vpnv4
Qtech(config router af)# neighbor 172.168.0.3 activate
Qtech(config router af)# neighbor 172.168.0.2 activate
Qtech(config router af)# end
```

Configure CE neighbors through EBGP.

```
Qtech# configure terminal
Qtech(config)# router bgp 1
Qtech(config router)# address family ipv4 vrf from spoke
Qtech(config router af)# neighbor 192.168.30.2 remote as 65004
Qtech(config router af)# neighbor 192.168.30.2 as override
Qtech(config router af)# exit
Qtech(config router)# address family ipv4 vrf from hub
Qtech(config router af)# neighbor 192.168.40.2 remote as 65004
Qtech(config router af)# neighbor 192.168.40.2 allows in
Qtech(config router af)# exit
```

Configure the MPLS signaling on the backbone network and enable MPLS on the public network interface.

```
Qtech# configure terminal
Qtech(config)# mpls ip
Qtech(config)# mpls router ldp
Qtech(config mpls router)# ldp router id interface loopback 0 force
Qtech(config mpls router)# exit
Qtech(config)# interface gigabitethernet 1/1
```

Use the **no switchport** command to switch the port mode on the switch series to the Routed Port mode. This command is not applicable to routers.

```
Qtech(config if GigabitEthernet 1/1)# no switchport
```

Enable MPLS fast forwarding on a router. This command is unnecessary on a switch.

```
Qtech(config if GigabitEthernet 1/1)# no switchport
Qtech(config if GigabitEthernet 1/1)# ip address 172.168.30.2 255.255.255.0
Qtech(config if GigabitEthernet 1/1)# label switching
Qtech(config if GigabitEthernet 1/1)# mpls ip
Qtech(config if GigabitEthernet 1/1)# end
```

Configure routing protocols on the backbone network.

```
Qtech# configure terminal
Qtech(config)# router ospf 10
Qtech(config router)# network 172.168.30.0 0.0.0.255 area 0
Qtech(config router)# network 172.168.0.2 0.0.0.0 area 0
Qtech(config router)# end
```

VPNA-SITEA:

Configure a PE session through EBGP.

```
Qtech# configure terminal
Qtech(config)# router bgp 65004
Qtech(config router)# neighbor 192.168.100.2 remote as 1
Qtech(config router)# exit
```

The configuration of VPNA-SITEB is similar to that of VPNA-SITEA.

VPNA-SITEC:

Configure a PE session through EBGP.

```
Qtech# configure terminal
Qtech(config)# router bgp 65004
Qtech(config router)# neighbor 192.168.30.1 remote as 1
Qtech(config router)# neighbor 192.168.40.1 remote as 1
Qtech(config router)# exit
```

3.4.4 Internet Unified Egress Interface Configuration Example

Networking Requirements

Several VPNs cannot access each other, but the VPNs need to access the Internet through a device. As shown in Figure 27 and Figure 28, VPN1 and VPN2 cannot access each other but can access the Internet through PE1.

To isolate them, you can use centralized isolation or the distributed isolation. The differences between the above solutions are as follows:

For the centralized isolation, add filtering rules on a CE egress interface for subsequent added VPN nodes to access the Internet through the unified egress interface. Other VPN nodes do not need any change of configuration. This solution features good scalability. The disadvantage of this solution is that isolated packets can be discarded only when they reach the CE egress interface, which consumes network bandwidth.

For the distributed isolation, add filtering rules on the CE of each VPN node that needs to access the Internet. This solution features poor scalability. The advantage of this solution is that isolated packets are discarded on the CE of a VPN node, which saves network bandwidth.

Requirement: Several VPNs cannot access each other, but the VPNs need to access the Internet through a device. As shown in the following figure, VPN1 and VPN2 cannot access each other but can access the Internet through PE1.

To isolate them, you can use centralized control isolation or the distributed control isolation. The differences between the above solutions are as follows:

For the centralized isolation, add filtering rules on a CE egress interface for subsequent added VPN nodes to access the Internet through the unified egress interface. Other VPN nodes do not need any change of configuration. This solution features good scalability. The disadvantage of this solution is that isolated packets can be discarded only when they reach the CE egress interface, which consumes network bandwidth.

For the distributed isolation, add filtering rules on the CE of each VPN node that needs to access the Internet. This solution features poor scalability. The advantage of this solution is that isolated packets are discarded on the CE of a VPN node, which saves network bandwidth.

3.4.4.1 Centralized Isolation

Figure 27

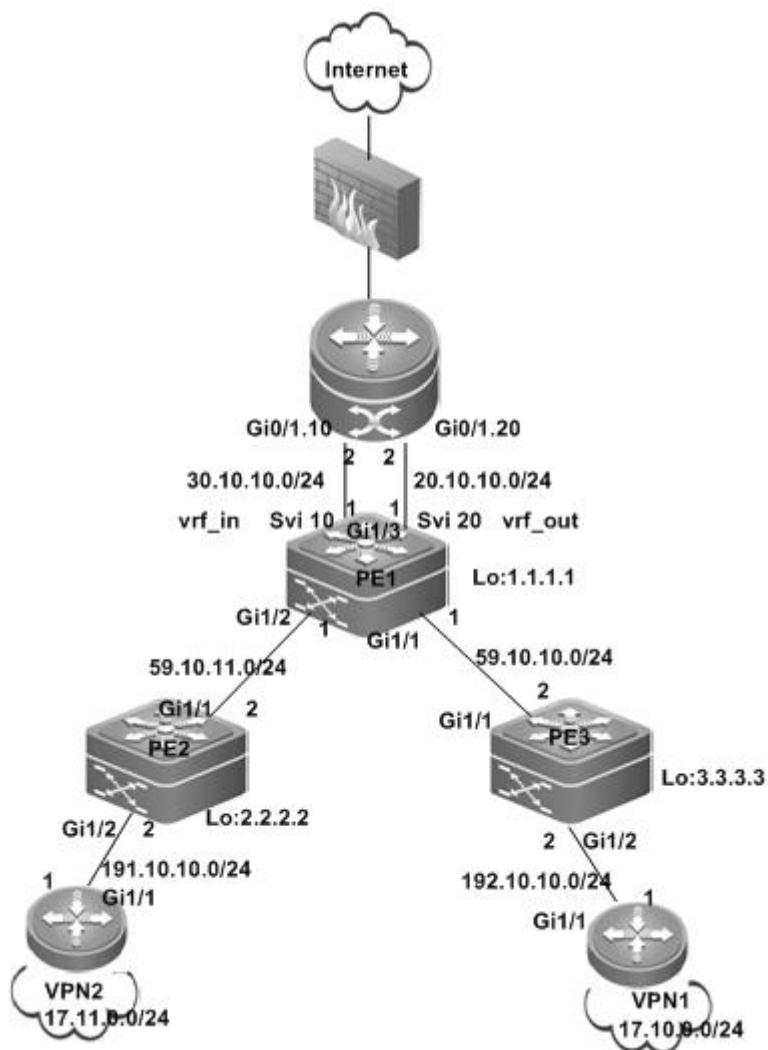

Configuration steps:

❖ Configure PE2

Configure the loopback interface.

```
Qtech# configure terminal
Qtech(config)# interface loopback 0
Qtech(config if Loopback 0)# ip address 2.2.2.2 255.255.255.255
```

Configure the VRF.

Create a VRF, create VPN1, and define the RD and RT.

```
Qtech# configure terminal
Qtech(config)# ip vrf VPN1
Qtech(config vrf)# rd 1:100
```

```
Qtech(config vrf)# route target both 1:100
Qtech(config vrf)# end
```

Associate the VRF with an interface.

```
Qtech# configure terminal
Qtech(config)# interface gigabitethernet 1/2
```

Use the `no switchport` command to switch the port mode on the switch series to the Routed Port mode. This command is not applicable to routers.

```
Qtech(config if GigabitEthernet 1/2)# no switchport
Qtech(config if GigabitEthernet 1/2)# ip vrf forwarding VPN1
Qtech(config if GigabitEthernet 1/2)# ip address 191.10.10.2
255.255.255.0
Qtech(config if GigabitEthernet 1/2)# end
```

Configure OSPF route interaction with CE2.

```
Qtech# configure terminal
Qtech(config)# router ospf 10 vrf VPN2
Qtech(config router)# network 191.10.10.0 0.0.0.255 area 0
Qtech(config router)# default information originate
Qtech(config router)# redistribute bgp subnets
Qtech(config router)# exit
```

Configure iBGP neighbors of PE1.

```
Qtech# configure terminal
Qtech(config)# router bgp 1
Qtech(config router)# neighbor 1.1.1.1 remote as 1
Qtech(config router)# neighbor 1.1.1.1 update source loopback 0
Qtech(config router)# address family vpnv4
Qtech(config router af)# neighbor 1.1.1.1 activate
Qtech(config router af)# end
```

Configure IP route distribution.

```
Qtech(config)# router bgp 1
Qtech(config router)# address family ipv4 vrf VPN1
Qtech(config router af)# redistribute ospf 10
Qtech(config router af)# end
```

Configure MPLS signaling for the backbone network and enable MPLS on the public network interface.

```
Qtech# configure terminal
Qtech(config)# mpls ip
Qtech(config)# mpls router ldp
Qtech(config mpls router)# ldp router id interface loopback 0 force
Qtech(config mpls router)# exit
Qtech(config)# interface gigabitethernet 1/1
```

Use the **no switchport** command to switch the port mode on the switch series to the Routed Port mode. This command is not applicable to routers.

```
Qtech(config if GigabitEthernet 1/1)# no switchport
Qtech(config if GigabitEthernet 1/1)# ip address 59.10.11.2
255.255.255.0
Qtech(config if GigabitEthernet 1/1)# label switching
Qtech(config if GigabitEthernet 1/1)# mpls ip
Qtech(config if GigabitEthernet 1/1)# end
```

Configure the routing protocol for the backbone network.

```
Qtech# configure terminal
Qtech(config)# router ospf 1
Qtech(config router)# network 59.10.11.0 0.0.0.255 area 0
Qtech(config router)# network 2.2.2.2 0.0.0.0 area 0
Qtech(config router)# end
```

❖ Configure CE2

Configure the IP address of an interface connecting to PE2.

```
Qtech# configure terminal
Qtech(config)# interface gigabitethernet 1/1
```

Use the **no switchport** command to switch the port mode on the switch series to the Routed Port mode. This command is not applicable to routers.

```
Qtech(config if GigabitEthernet 1/1)# no switchport
Qtech(config if GigabitEthernet 1/1)# ip address 191.10.10.1 255.255.255.0
```

Configure OSPF route interaction with PE2.

```
Qtech# configure terminal
Qtech(config)# router ospf 1
Qtech(config router)# network 191.10.10.0 0.0.0.255 area 0
Qtech(config router)# network 172.11.0.0 0.0.0.255 area 0
Qtech(config router)# exit
```

❖ Configure PE3

The configuration process is similar to the PE2 configuration. Assume that the export and import RT of VPN2 is 1: 200.

❖ Configure PE1

Configure the loopback interface.

```
Qtech# configure terminal
Qtech(config)# interface loopback 0
Qtech(config if Loopback 0)# ip address 1.1.1.1 255.255.255.255
```

Create the trunk interface.

```
Qtech# configure terminal
Qtech(config)# interface gigabitethernet 1/3
Qtech(config)# switch mode trunk
Qtech(config)# switch trunk vlan allow remove vlan 1 9,11 19,21 4094
```

Configure the out_vrf as the outbound interface for accessing the Internet.

Create a VRF, configure the vrf_out, define the RD and RT, and associate the VRF with the corresponding interface.

```
Qtech# configure terminal
Qtech(config)# ip vrf vrf_out
Qtech(config vrf)# rd 1:300
Qtech(config vrf)# route target export 1:100
Qtech(config vrf)# route target export 1:200
Qtech(config vrf)# end
```

Bind the interface with the VRF.

```
Qtech# configure terminal
Qtech(config)#interface vlan 20
Qtech(config if Vlan 20)# ip vrf forwarding vrf_out
Qtech(config if Vlan 20)# ip address 20.10.10.1 255.255.255.0
```

Configure the default route to the Internet.

```
Qtech# configure terminal
Qtech(config)# ip route vrf vrf_out 0.0.0.0 0.0.0.0 vlan 20 20.10.10.2
```

Configure in_vrf as the incoming interface of traffic returned from the Internet.

Create a VRF, configure the vrf_in, define the RD and RT, and associate the VRF with the corresponding interface.

```
Qtech# configure terminal
Qtech(config)# ip vrf vrf_in
Qtech(config vrf)# rd 1:400
Qtech(config vrf)# route target import 1:100
Qtech(config vrf)# route target import 1:200
Qtech(config vrf)# end
```

Bind the interface with the VRF.

```
Qtech# configure terminal
Qtech(config)#interface vlan 10
Qtech(config if Vlan 20)# ip vrf forwarding vrf_in
Qtech(config if Vlan 20)# ip address 30.10.10.1 255.255.255.0
```

Configure eBGP route interaction with CE1.

```
Qtech# configure terminal
Qtech(config)# router bgp 1
```

```
Qtech(config router)# address family ipv4 vrf vrf_in
Qtech(config router af)# neighbor 30.10.10.2 remote as 100
```

Configure iBGP neighbors of PE1 and PE3.

```
Qtech# configure terminal
Qtech(config)# router bgp 1
Qtech(config router)# neighbor 2.2.2.2 remote as 1
Qtech(config router)# neighbor 2.2.2.2 update source loopback 0
Qtech(config router)# neighbor 3.3.3.3 remote as 1
Qtech(config router)# neighbor 3.3.3.3 update source loopback 0
Qtech(config router)# address family vpnv4
Qtech(config router af)# neighbor 2.2.2.2 activate
Qtech(config router af)# neighbor 3.3.3.3 activate
Qtech(config router af)# end
```

Configure VRF vrf_out route interaction.

```
Qtech(config)# router bgp 1
Qtech(config router)# address family ipv4 vrf vrf_out
Qtech(config router af)# default information originate
Qtech(config router af)# redistribute static
Qtech(config router af)# end
```

Configure MPLS signaling for the backbone network and enable MPLS on the public network interface.

```
Qtech# configure terminal
Qtech(config)# mpls ip
Qtech(config)# mpls router ldp
Qtech(config mpls router)# ldp router id interface loopback 0 force
Qtech(config mpls router)# exit
Qtech(config)# interface gigabitethernet 1/2
```

Use the `no switchport` command to switch the port mode on the switch series to the Routed Port mode. This command is not applicable to routers.

```
Qtech(config if GigabitEthernet 1/2)# no switchport
Qtech(config if GigabitEthernet 1/2)# ip address 59.10.11.1
255.255.255.0
Qtech(config if GigabitEthernet 1/2)# label switching
Qtech(config if GigabitEthernet 1/2)# mpls ip
Qtech(config if GigabitEthernet 1/2)# end
Qtech(config)# interface gigabitethernet 1/1
```

Use the `no switchport` command to switch the port mode on the switch series to the Routed Port mode. This command is not applicable to routers.

```
Qtech(config if GigabitEthernet 1/1)# no switchport
Qtech(config if GigabitEthernet 1/1)# ip address 59.10.10.1
```

```
255.255.255.0
```

```
Qtech(config if GigabitEthernet 1/1)# label switching
Qtech(config if GigabitEthernet 1/1)# mpls ip
Qtech(config if GigabitEthernet 1/1)# end
```

Configure the routing protocol for the backbone network.

```
Qtech# configure terminal
Qtech(config)# router ospf 1
Qtech(config router)# network 59.10.11.0 0.0.0.255 area 0
Qtech(config router)# network 59.10.10.0 0.0.0.255 area 0
Qtech(config router)# network 1.1.1.1 0.0.0.0 area 0
Qtech(config router)# end
```

❖ Configure CE1.

Create the subinterface.

```
Qtech# configure terminal
Qtech(config)# interface gigabitethernet 0/1.10
Qtech(config if GigabitEthernet 0/1.10)# encapsulation dot1q 10
Qtech(config if GigabitEthernet 0/1.10)# ip address 30.10.10.2 255.255.255.0
Qtech(config)# exit
Qtech(config)# interface gigabitethernet 0/1.20
Qtech(config if GigabitEthernet 0/1.20)# encapsulation dot1q 20
Qtech(config if GigabitEthernet 0/1.20)# ip address 20.10.10.2 255.255.255.0
```

Configure eBGP neighbors of PE1.

```
Qtech# configure terminal
Qtech(config)# router bgp 100
Qtech(config)# neighbor 30.10.10.1 remote as 1
```

Create an ACL.

```
Qtech(config)#access list 1 deny 17.0.0.0 0.255.255.255
Qtech(config)# access list 1 permit any
```

Configure the ACL on the subinterface Gi 0/1.10.

```
Qtech(config)# interface gigabitethernet 0/1.10
Qtech(config if GigabitEthernet 0/1.10)# ip access group 1 out
```

3.4.4.2 Distributed Isolation

Figure 28

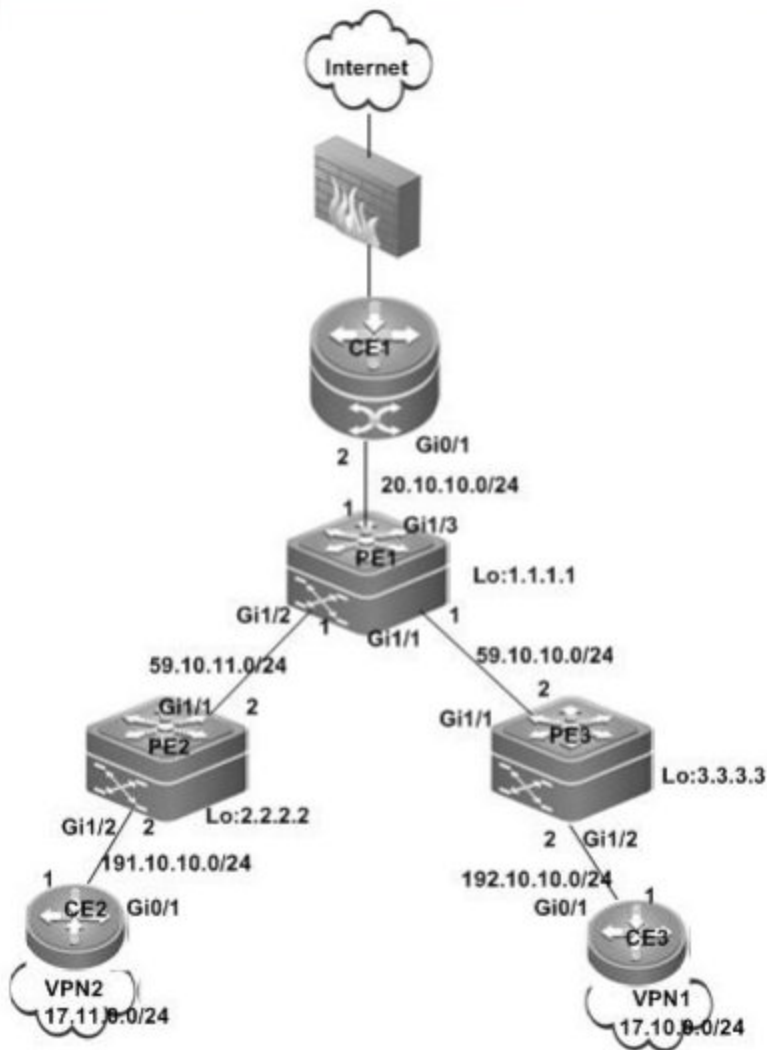

❖ Configure PE1

Configure the loopback interface.

This configuration is the same as Centralized Isolation.

Configure the VRF.

Create a VRF, create vrf_net, and define the RD and RT.

```
Qtech# configure terminal
Qtech(config)# ip vrf vrf_net
Qtech(config-vrf)# rd 1:300
Qtech(config-vrf)# route-target import 1:100
Qtech(config-vrf)# route-target import 1:200
Qtech(config-vrf)# route-target export 1:100
Qtech(config-vrf)# route-target export 1:200
```

Associate the VRF with an interface.

```
Qttech# configure terminal
```

```
Qttech(config)# interface gigabitethernet 1/3
```

Use the `no switchport` command to switch the port mode on the switch series to the Routed Port mode. This command is not applicable to routers.

```
Qttech(config if GigabitEthernet 1/3)# no switchport
```

```
Qttech(config if GigabitEthernet 1/3)# ip vrf forwarding vrf_net
```

```
Qttech(config if GigabitEthernet 1/3)# ip address 20.10.10.1 255.255.255.0
```

Configure the default route to the Internet.

```
Qttech(config)#ip route vrf vrf_net 0.0.0.0 0.0.0.0 gigabitethernet 1/3 20.10.10.2
```

Configure eBGP route interaction for CE1.

```
Qttech# configure terminal
```

```
Qttech(config)# router bgp 1
```

```
Qttech(config router)# address family ipv4 vrf vrf_net
```

```
Qttech(config router af)# neighbor 20.10.10.2 remote as 100
```

Configure iBGP neighbors of PE1 and PE3.

```
Qttech# configure terminal
```

```
Qttech(config)# router bgp 1
```

```
Qttech(config router)# neighbor 2.2.2.2 remote as 1
```

```
Qttech(config router)# neighbor 2.2.2.2 update source loopback 0
```

```
Qttech(config router)# neighbor 3.3.3.3 remote as 1
```

```
Qttech(config router)# neighbor 3.3.3.3 update source loopback 0
```

```
Qttech(config router)# address family vpnv4
```

```
Qttech(config router af)# neighbor 2.2.2.2 activate
```

```
Qttech(config router af)# neighbor 3.3.3.3 activate
```

```
Qttech(config router af)# end
```

Configure VRF vrf_net route interaction.

```
Qttech(config)# router bgp 1
```

```
Qttech(config router)# address family ipv4 vrf vrf_net
```

```
Qttech(config router af)# default information originate
```

```
Qttech(config router af)# redistribute static
```

```
Qttech(config router af)# end
```

Configure MPLS and routes for the backbone network.

This configuration is the same as Centralized Isolation.

❖ **Configure CE1.**

```
Qttech(config)# interface gigabitethernet 0/1
```

```
Qttech(config if GigabitEthernet 0/1)# ip address 20.10.10.2 255.255.255.0
```

Configure eBGP neighbors of PE1.

```
Qttech# configure terminal
```

```
Qttech(config)# router bgp 100
Qttech(config router)# neighbor 20.10.10.1 remote as 1
```

❖ Configure PE2

This configuration is the same as Centralized Isolation.

❖ Configure CE2

Configure an ACL.

```
Qttech# configure terminal
Qttech(config)# access list 2000 deny ip any 17.10.0.0 0.0.255.255
Qttech(config)# access list 2000 permit ip any any
```

Configure the ACL application interface.

```
Qttech(config)# interface gigabitethernet 0/1
Qttech(config if Gigabitethernet 0/1)# ip access group 2000 out
```

Configure route interaction with PE2.

This configuration is the same as Centralized Isolation.

Configure the default static route.

This configuration is the same as Centralized Isolation.

Configure PE3

This configuration is the same as Centralized Isolation.

Configure CE3.

Configure an ACL.

```
Qttech# configure terminal
Qttech(config)# access list 2000 deny ip any 17.11.0.0 0.0.255.255
Qttech(config)# access list 2000 permit ip any any
```

Configure the ACL application interface.

```
Qttech(config)# interface gigabitethernet 0/1
Qttech(config if Gigabitethernet 0/1)# ip access group 2000 out
```

Other configuration is the same as Centralized Isolation.

3.4.5 Inter-AS VPN OptionB: Next Hop Unchanged

Requirement: One VPN user has sites at both ASs. It is required that the VPN sites in different ASs access each other.

Figure 29 OptionB: Next Hop Unchanged

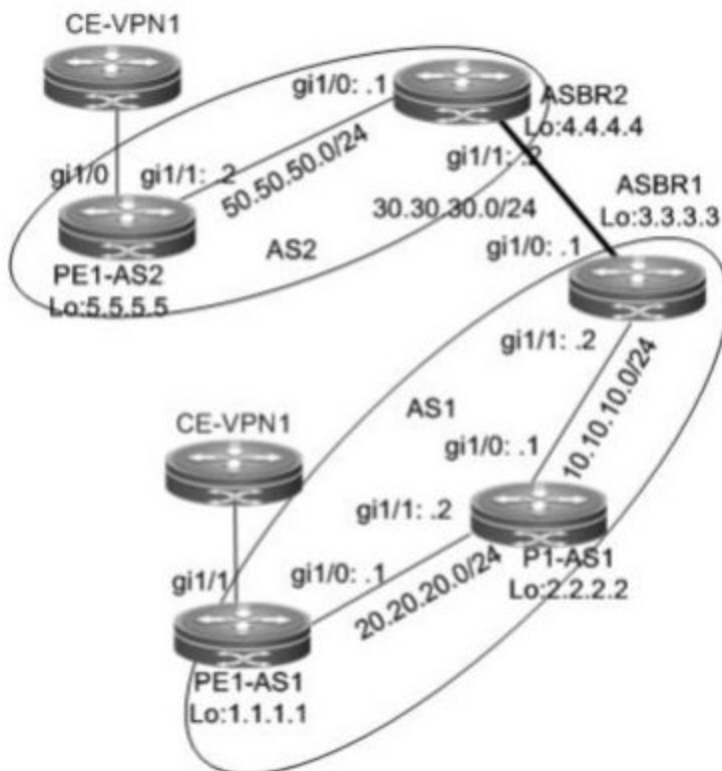

The configuration scheme is as follows:

PE1-AS1:

Configure the loopback interface.

```
Qtech# configure terminal
Qtech(config)# interface loopback 0
Qtech(config-if-Loopback 0)# ip address 1.1.1.1 255.255.255.255
```

Configure the VRF.

Create one VRF instance: VPN1. Set the RD and RT values, and associate the VRF with the corresponding interface.

```
Qtech# configure terminal
Qtech(config)# ip vrf VPN1
Qtech(config-vrf)# rd 1:100
Qtech(config-vrf)# route-target both 1:100
Qtech(config-vrf)# end
```

Associate the VRF with an interface.

```
Qtech# configure terminal
Qtech(config)# interface gigabitethernet 1/1
```

Use the **no switchport** command to switch the port mode on the switch series to the Routed Port mode. This command is not applicable to routers.

```
Qtech(config if GigabitEthernet 1/1)# no switchport
Qtech(config if GigabitEthernet 1/1)# ip vrf forwarding VPN1
Qtech(config if GigabitEthernet 1/1)# ip address 192.168.16.2
255.255.255.0
Qtech(config if GigabitEthernet 1/1)# end
```

Enable BGP and set up MP-IBGP sessions with ASBR1.

```
Qtech# configure terminal
Qtech(config)# router bgp 1
Qtech(config router)# neighbor 3.3.3.3 remote as 1
Qtech(config router)# neighbor 3.3.3.3 update source loopback 0
Qtech(config router)# address family vpnv4
Qtech(config router af)# neighbor 3.3.3.3 activate
Qtech(config router af)# end
```

Configure CE neighbors through EBGP.

Refer to the configuration procedure in Running BGP Between a PE and CE to Transmit VPN Routes.

Configure the MPLS signaling on the backbone network and enable MPLS on the public network interface.

```
Qtech# configure terminal
Qtech(config)# mpls ip
Qtech(config)# mpls router ldp
Qtech(config mpls router)# ldp router id interface loopback 0 force
Qtech(config mpls router)# exit
Qtech(config)# interface gigabitethernet 1/0
```

Use the **no switchport** command to switch the port mode on the switch series to the Routed Port mode. This command is not applicable to routers.

```
Qtech(config if GigabitEthernet 1/0)# no switchport
Qtech(config if GigabitEthernet 1/0)# ip address 20.20.20.1
255.255.255.0
Qtech(config if GigabitEthernet 1/0)# label switching
Qtech(config if GigabitEthernet 1/0)# mpls ip
Qtech(config if GigabitEthernet 1/0)# end
```

Configure routing protocols on the backbone network.

```
Qtech# configure terminal
Qtech(config)# router ospf 10
Qtech(config router)# network 20.20.20.0 0.0.0.255 area 0
Qtech(config router)# network 1.1.1.1 0.0.0.0 area 0
Qtech(config router)# end
```

The procedure of **PE1-AS2** is similar to the preceding one.

P1-AS1:

Configure the loopback interface.

```
Qtech# configure terminal
Qtech(config)# interface loopback 0
Qtech(config-if Loopback 0)# ip address 2.2.2.2 255.255.255.255
```

Configure the MPLS signaling on the backbone network and enable MPLS on the public network interface.

```
Qtech# configure terminal
Qtech(config)# mpls ip
Qtech(config)# mpls router ldp
Qtech(config-mpls-router)# ldp router id interface loopback 0 force
Qtech(config-mpls-router)# exit
Qtech(config)# interface gigabitethernet 1/0
```

Use the **no switchport** command to switch the port mode on the switch series to the Routed Port mode. This command is not applicable to routers.

```
Qtech(config-if GigabitEthernet 1/0)# no switchport
Qtech(config-if GigabitEthernet 1/0)# ip address 10.10.10.1
255.255.255.0
Qtech(config-if GigabitEthernet 1/0)# label switching
Qtech(config-if GigabitEthernet 1/0)# mpls ip
Qtech(config-if GigabitEthernet 1/0)# exit
Qtech(config)# interface gigabitethernet 1/1
```

Use the **no switchport** command to switch the port mode on the switch series to the Routed Port mode. This command is not applicable to routers.

```
Qtech(config-if GigabitEthernet 1/1)# no switchport
Qtech(config-if GigabitEthernet 1/1)# ip address 20.20.20.2
255.255.255.0
Qtech(config-if GigabitEthernet 1/1)# label switching
Qtech(config-if GigabitEthernet 1/1)# mpls ip
```

Configure routing protocols on the backbone network.

```
Qtech# configure terminal
Qtech(config)# router ospf 10
Qtech(config-router)# network 20.20.20.0 0.0.0.255 area 0
Qtech(config-router)# network 10.10.10.0 0.0.0.255 area 0
Qtech(config-router)# network 2.2.2.2 0.0.0.0 area 0
Qtech(config-router)# end
```

ASBR1:

Configure the loopback interface.

```
Qtech# configure terminal
```

```
Qtech(config)# interface loopback 0
Qtech(config if Loopback 0)# ip address 3.3.3.3 255.255.255.255
```

Enable BGP, disable the BGP RF filtering function, and set up neighbor relations with PE1-AS1 and ASBR2.

```
Qtech# configure terminal
Qtech(config)# router bgp 1
Qtech(config router)# no bgp default route target filter
Qtech(config router)# neighbor 1.1.1.1 remote as 1
Qtech(config router)# neighbor 1.1.1.1 update source loopback 0
Qtech(config router)# neighbor 30.30.30.2 remote as 2
Qtech(config router)# address family vpnv4 unicast
Qtech(config router af)# neighbor 1.1.1.1 activate
Qtech(config router af)# neighbor 30.30.30.2 activate
Qtech(config router af)# end
```

Configure MPLS signaling and enable MPLS on a public network interface.

```
Qtech# configure terminal
Qtech(config)# mpls ip
Qtech(config)# mpls router ldp
Qtech(config mpls router)# ldp router id interface loopback 0 force
Qtech(config mpls router)# exit
Qtech(config)# interface gigabitethernet 1/1
```

Use the **no switchport command to switch the port mode on the switch series to the Routed Port mode. This command is not applicable to routers.**

```
Qtech(config if GigabitEthernet 1/1)# no switchport
Qtech(config if gigabitethernet 1/1)# ip address 10.10.10.2
255.255.255.0
Qtech(config if gigabitethernet 1/1)# label switching
Qtech(config if gigabitethernet 1/1)# mpls ip
Qtech(config if gigabitethernet 1/1)# end
```

Run OSPF on the backbone network to transmit routes and redistribute directly connected network routes.

```
Qtech# configure terminal
Qtech(config)# router ospf 10
Qtech(config router)# network 10.10.10.0 0.0.0.255 area 0
Qtech(config router)# network 3.3.3.3 0.0.0.0 area 0
Qtech(config router)# redistribute connected subnets
Qtech(config router)# end
```

Assign an IP address to the interface connected to ASBR2.

```
Qtech(config)# interface gigabitethernet 1/0
```

Use the **no switchport** command to switch the port mode on the switch series to the Routed Port mode. This command is not applicable to routers.

```
Qtech(config-if GigabitEthernet 1/0)# no switchport
Qtech(config-if gigabitEthernet 1/0)# ip address 30.30.30.1
255.255.255.0
# Enable label switching on an interface.
Qtech(config-if gigabitEthernet 1/0)# label switching
```

The configuration of ASBR2 is similar to that of ASBR1.

3.4.6 Inter-AS VPN OptionB: Next Hop Changed

Requirement: One VPN user has sites at both ASs. It is required that the VPN sites in different ASs access each other.

Figure 30 OptionB: Next Hop Changed

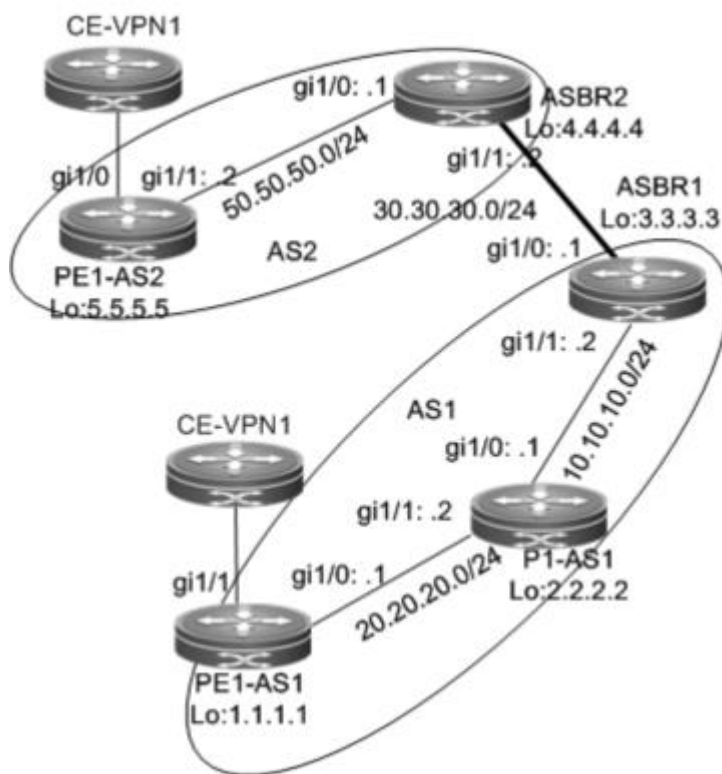

The configuration scheme is as follows:

PE1-AS1:

The configuration procedure is similar to that of PE1-AS1 in Inter AS VPN OptionB: Next Hop Unchanged and is not described here.

P1-AS1:

The configuration procedure is similar to that of P1-AS1 in Inter AS VPN OptionB: Next Hop Unchanged and is not described here.

ASBR1:

Configure the loopback interface.

```
Qtech# configure terminal
Qtech(config)# interface loopback 0
Qtech(config-if Loopback 0)# ip address 3.3.3.3 255.255.255.255
```

Enable BGP, disable the BGP RT filtering function, set up neighbor relations with the PE and ASBR, and modify the next hop of routes to the neighbor PE as the local address.

```
Qtech# configure terminal
Qtech(config)# router bgp 1
Qtech(config-router)# no bgp default route target filter
Qtech(config-router)# neighbor 1.1.1.1 remote as 1
Qtech(config-router)# neighbor 1.1.1.1 update source loopback 0
Qtech(config-router)# neighbor 30.30.30.2 remote as 2
Qtech(config-router)# address family vpnv4 unicast
Qtech(config-router-af)# neighbor 1.1.1.1 activate
Qtech(config-router-af)# neighbor 1.1.1.1 next hop self
Qtech(config-router-af)# neighbor 30.30.30.2 activate
Qtech(config-router-af)# end
```

Configure MPLS signaling and enable MPLS on a public network interface.

```
Qtech# configure terminal
Qtech(config)# mpls ip
Qtech(config)# mpls router ldp
Qtech(config-mpls-router)# ldp router id interface loopback 0 force
Qtech(config-mpls-router)# exit
Qtech(config)# interface gigabitethernet 1/1
```

Use the `no switchport` command to switch the port mode on the switch series to the Routed Port mode. This command is not applicable to routers.

```
Qtech(config-if gigabitethernet 1/1)# no switchport
Qtech(config-if gigabitethernet 1/1)# ip address 10.10.10.2
255.255.255.0
Qtech(config-if gigabitethernet 1/1)# label switching
Qtech(config-if gigabitethernet 1/1)# mpls ip
Qtech(config-if gigabitethernet 1/1)# end
```

Run OSPF on the backbone network to transmit routing information.

```
Qtech# configure terminal
Qtech(config)# router ospf 10
Qtech(config-router)# network 10.10.10.0 0.0.0.255 area 0
```



```
Qtech(config router)# network 3.3.3.3 0.0.0.0 area 0
Qtech(config router)# end
```

Assign an IP address to the interface connected to ASBR2.

```
Qtech(config)# interface gigabitethernet 1/0
```

Use the **no switchport** command to switch the port mode on the switch series to the Routed Port mode. This command is not applicable to routers.

```
Qtech(config if GigabitEthernet 1/0)# no switchport
Qtech(config if gigabitethernet 1/0)# ip address 30.30.30.1
255.255.255.0
```

Enable label switching on an interface.

```
Qtech(config if gigabitethernet 1/0)# label switching
```

The configuration of ASBR2 is similar to that of ASBR1.

3.4.7 Inter-AS VPN OptionC: Enabling IPv4 Label Exchange Between EBGP Neighbors

Requirement: One VPN user has sites at both ASs. It is required that the VPN sites in different ASs access each other.

Figure 31 OptionC: enabling IPv4 label switching between EBGP neighbors

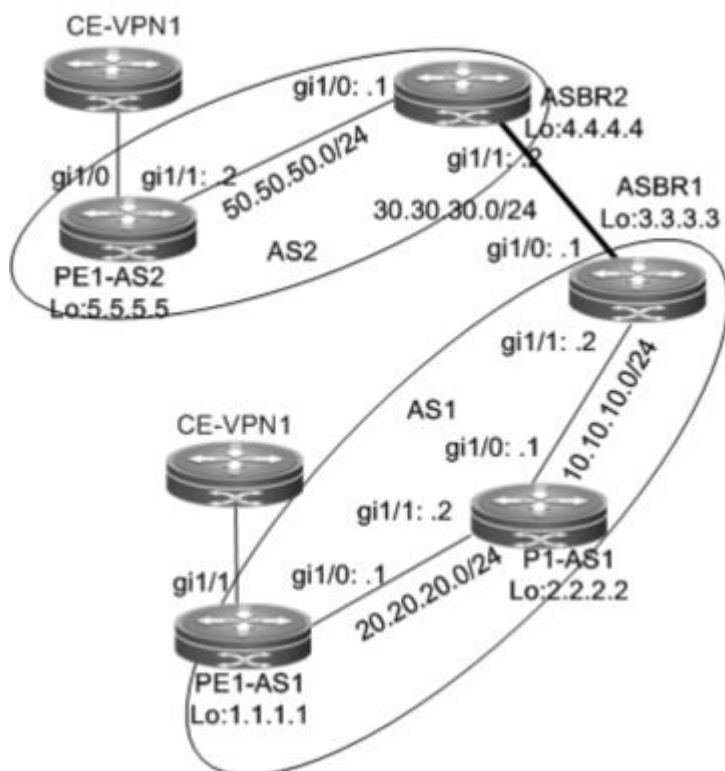

The configuration scheme is as follows:

PE1-AS1:

Configure the loopback interface.

```
Qtech# configure terminal
Qtech(config)# interface loopback 0
Qtech(config if Loopback 0)# ip address 1.1.1.1 255.255.255.255
```

Configure the VRF.

Configure a multi-hop MP-EBGP session and disable IPv4 route exchange for the session.

```
Qtech# configure terminal
Qtech(config)# router bgp 1
Qtech(config router)# neighbor 5.5.5.5 remote as 2
Qtech(config router)# neighbor 5.5.5.5 update source loopback 0
Qtech(config router)# neighbor 5.5.5.5 ebgp multihop
Qtech(config router)# address family ipv4
Qtech(config router af)# no neighbor 5.5.5.5 activate
```

```
Qtech(config router af)# exit
Qtech(config router)# address family vpnv4 unicast
Qtech(config router af)# neighbor 5.5.5.5 activate
Qtech(config router af)# end
```

Configure CE neighbors through EBGP.

Configure MPLS signaling and enable MPLS on a public network interface.

```
Qtech# configure terminal
Qtech(config)# mpls ip
Qtech(config)# mpls router ldp
Qtech(config mpls router)# ldp router id interface loopback 0 force
Qtech(config mpls router)# exit
Qtech(config)# interface gigabitethernet 1/1
```

Use the `no switchport` command to switch the port mode on the switch series to the Routed Port mode. This command is not applicable to routers.

```
Qtech(config if gigabitethernet 1/1)# no switchport
Qtech(config if gigabitethernet 1/1)# ip address 20.20.20.1
255.255.255.0
Qtech(config if gigabitethernet 1/1)# label switching
Qtech(config if gigabitethernet 1/1)# mpls ip
Qtech(config if gigabitethernet 1/1)# end
```

Run OSPF on the backbone network to transmit routing information.

```
Qtech# configure terminal
Qtech(config)# router ospf 10
Qtech(config router)# network 20.20.20.0 0.0.0.255 area 0
Qtech(config router)# network 1.1.1.1 0.0.0.0 area 0
Qtech(config router)# end
```

P1-AS1:

The configuration mainly includes the MPLS signaling protocol and IGP and is not described here.

ASBR1:

Configure the loopback interface.

```
Qtech# configure terminal
Qtech(config)# interface loopback 0
Qtech(config if Loopback 0)# ip address 3.3.3.3 255.255.255.255
```

Configure ACL rules and route map rules to assign labels to or set labels only for routes that match the rules.

```
Qtech# configure terminal
Qtech(config)# ip access list extended 101
Qtech(config ext nacl)# permit ip host 1.1.1.1 any
```

```
uijie(config ext nacl)# exit
Qtech(config)# ip access list extended 102
Qtech(config ext nacl)# permit ip host 5.5.5.5 any
Qtech(config ext nacl)# exit
Qtech(config)# route map set mpls
Qtech(config route map)# match ip address 101
Qtech(config route map)# set mpls label
Qtech(config route map)# exit
Qtech(config)# route map external pe route
Qtech(config route map)# match ip address 102
Qtech(config route map)# end
```

Set up an EBGP session with ASBR2 and configure route map rules to assign labels to PE routes that match the rules (the route map rules are optional and allow BGP to assign labels to only certain routes), and configure static routes to PEs in the local AS.

```
Qtech# configure terminal
Qtech(config)# router bgp 1
Qtech(config router)# neighbor 30.30.30.2 remote as 2
Qtech(config router)# address family ipv4
Qtech(config router af)# neighbor 30.30.30.2 send label
Qtech(config router af)# neighbor 30.30.30.2 route map set mpls out
Qtech(config router af)# network 1.1.1.1 mask 255.255.255.255
Qtech(config router af)# end
```

Configure MPLS to assign label to certain BGP routes through ACL rules (The ACL rules are optional and allow you to reduce the number of unnecessary routes).

```
Qtech# configure terminal
Qtech(config)# mpls ip
Qtech(config)# mpls router ldp
Qtech(config mpls router)# ldp router id interface loopback 0 force
Qtech(config mpls router)# advertise labels for bgp routes acl 102
Qtech(config mpls router)# exit
Qtech(config)# interface gigabitethernet 1/1
```

Use the **no switchport** command to switch the port mode on the switch series to the Routed Port mode. This command is not applicable to routers.

```
Qtech(config if Gigabitethernet 1/1)# no switchport
Qtech(config if Gigabitethernet 1/1)# ip address 10.10.10.2 255.255.255.0
Qtech(config if Gigabitethernet 1/1)# label switching
Qtech(config if Gigabitethernet 1/1)# mpls ip
Qtech(config if Gigabitethernet 1/1)# end
```

Configure a routing protocol on the backbone network to redistribute only BGP routes that match the route map rules (The route map rules are optional and allow you to reduce the number of unnecessary routes).

```
Qttech# configure terminal
Qttech(config)# router ospf 10
Qttech(config router)# network 10.10.10.0 0.0.0.255 area 0
Qttech(config router)# network 3.3.3.3 0.0.0.0 area 0
Qttech(config router)# redistribute bgp subnets route map external pe route
Qttech(config router)# end
```

Assign an IP address to the interface connected to ASBR2.

```
Qttech(config)# interface gigabitethernet 1/0
```

Use the `no switchport` command to switch the port mode on the switch series to the Routed Port mode. This command is not applicable to routers.

```
Qttech(config if GigabitEthernet 1/0)# no switchport
Qttech(config if gigabitethernet 1/0)# ip address 30.30.30.1
255.255.255.0
```

Enable label switching on an interface.

```
Qttech(config if gigabitethernet 1/0)# label switching
```

The configuration of ASBR2 is similar to that of ASBR1.

3.4.8 Inter-AS VPN OptionC: Enabling IPv4 Label Exchange Between Both EBGP and IBGP Neighbors

Requirement: One VPN user has sites at both ASs. It is required that the VPN sites in different ASs access each other.

Figure 32 OptionC: enabling IPv4 label switching between both EBGP and IBGP neighbors

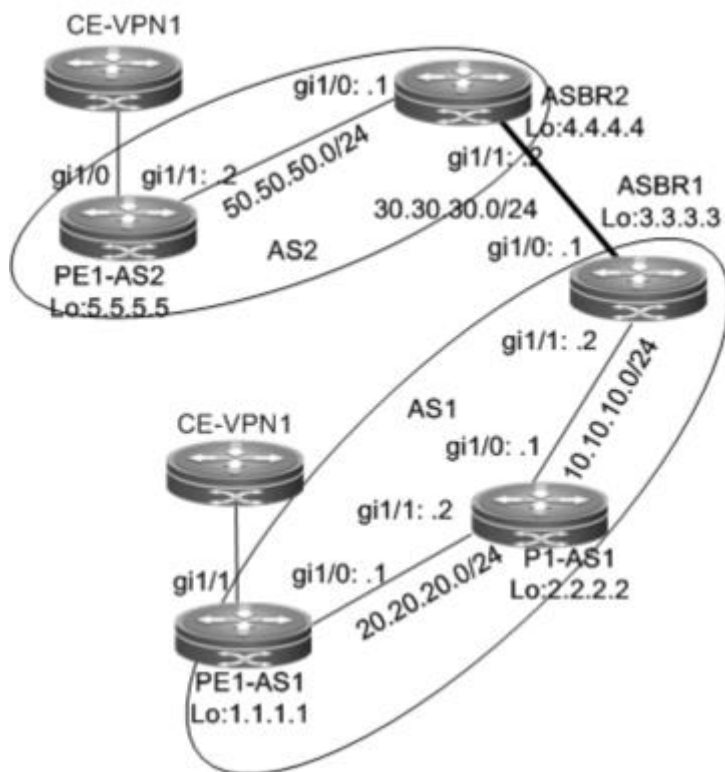

The configuration scheme is as follows:

PE1-AS1:

Configure the loopback interface.

```
Qtech# configure terminal
Qtech(config)# interface loopback 0
Qtech(config if Loopback 0)# ip address 1.1.1.1 255.255.255.255
```

Configure the VRF.

The configuration procedure is similar to that of PE1-AS1 in Inter AS VPN OptionB: Next Hop Unchanged and is not described here.

Configure a multi-hop MP-EBGP session and disable IPv4 route exchange for the session.

The configuration procedure is similar to that of Inter AS VPN OptionC: Enabling IPv4 Label Exchange Between EBGP Neighbors and is not described here.

Set up an IBGP session with the ASBR and enable IPv4 label switching.

```
Qtech# configure terminal
Qtech(config)# router bgp 1
Qtech(config router)# neighbor 3.3.3.3 remote as 1
Qtech(config router)# neighbor 3.3.3.3 update source loopback 0
Qtech(config router)# address family ipv4
Qtech(config router af)# neighbor 3.3.3.3 activate
Qtech(config router af)# neighbor 3.3.3.3 send label
Qtech(config router af)# end
```

Configure CE neighbors through EBGP.

Configure MPLS signaling and enable MPLS on a public network interface.

```
Qtech# configure terminal
Qtech(config)# mpls ip
Qtech(config)# mpls router ldp
Qtech(config mpls router)# ldp router id interface loopback 0 force
Qtech(config mpls router)# exit
Qtech(config)# interface gigabitethernet 1/0
```

Use the **no switchport** command to switch the port mode on the switch series to the Routed Port mode. This command is not applicable to routers.

```
Qtech(config if gigabitethernet 1/0)# no switchport
Qtech(config if gigabitethernet 1/0)# ip address 20.20.20.1
255.255.255.0
Qtech(config if gigabitethernet 1/0)# label switching
Qtech(config if gigabitethernet 1/0)# mpls ip
Qtech(config if gigabitethernet 1/0)# end
```

Run OSPF on the backbone network to transmit routing information.

```
Qtech# configure terminal
Qtech(config)# router ospf 10
Qtech(config router)# network 20.20.20.0 0.0.0.255 area 0
Qtech(config router)# network 1.1.1.1 0.0.0.0 area 0
Qtech(config router)# end
```

The configuration of PE1-AS2 is similar to that of PE1-AS1.

P1-AS1:

The configuration mainly includes the MPLS signaling protocol and IGP and is not described here.

ASBR1:

Configure the loopback interface.

```
Qtech# configure terminal
Qtech(config)# interface loopback 0
Qtech(config if Loopback 0)# ip address 3.3.3.3 255.255.255.255
```

Configure ACL rules and route map rules to assign labels to or set labels only for routes that match the rules.

```
Qtech# configure terminal
Qtech(config)# ip access list extended 101
Qtech(config)# permit ip host 1.1.1.1 any
Qtech(config)# exit
Qtech(config)# ip access list extended 102
Qtech(config)# permit ip host 5.5.5.5 any
Qtech(config)# route map internal mpls route permit 10
Qtech(config route map)# match ip address 101
Qtech(config route map)# set mpls label
Qtech(config route map)# exit
Qtech(config)# route map external mpls route permit 10
Qtech(config route map)# match ip address 102
Qtech(config route map)# set mpls label
Qtech(config route map)# end
```

Set up an EBGP session with the ASBR and configure route map rules to assign labels to PE routes that match the rules (the route map rules are optional and allow BGP to assign labels to only certain routes), and configure static routes to PEs in the local AS.

```
Qtech# configure terminal
Qtech(config)# router bgp 1
Qtech(config router)# neighbor 30.30.30.2 remote as 2
Qtech(config router)# neighbor 1.1.1.1 remote as 1
Qtech(config router)# neighbor 1.1.1.1 update source loopback 0
Qtech(config router)# address family ipv4
Qtech(config router af)# neighbor 30.30.30.2 send label
Qtech(config router af)# neighbor 30.30.30.2 route map internal mpls route out
Qtech(config router af)# neighbor 1.1.1.1 send label
Qtech(config router af)# neighbor 1.1.1.1 route map external mpls route out
Qtech(config router af)# network 1.1.1.1 mask 255.255.255.255
Qtech(config router af)# end
```

Configure MPLS signaling and enable MPLS on an interface.

```
Qtech# configure terminal
Qtech(config)# mpls ip
Qtech(config)# mpls router ldp
Qtech(config mpls router)# ldp router id interface loopback 0 force
Qtech(config mpls router)# exit
Qtech(config)# interface gigabitethernet 1/1
```

Use the **no switchport** command to switch the port mode on the switch series to the Routed Port mode. This command is not applicable to routers.

```
Qtech(config if Gigabitethernet 1/1)# no switchport
```



```
Qtech(config if GigabitEthernet 1/1)# ip address 10.10.10.2
255.255.255.0
Qtech(config if GigabitEthernet 1/1)# label switching
Qtech(config if GigabitEthernet 1/1)# mpls ip
Qtech(config if GigabitEthernet 1/1)# end
```

Run OSPF on the backbone network to transmit routing information.

```
Qtech# configure terminal
Qtech(config)# router ospf 10
Qtech(config router)# network 10.10.10.0 255.255.255.0 area 0
Qtech(config router)# network 3.3.3.3 0.0.0.0 area 0
Qtech(config router)# end
```

Assign an IP address to the interface connected to ASBR2.

```
Qtech(config)# interface gigabitEthernet 1/0
```

Use the **no switchport** command to switch the port mode on the switch series to the Routed Port mode. This command is not applicable to routers.

```
Qtech(config if GigabitEthernet 1/0)# no switchport
Qtech(config if gigabitEthernet 1/0)# ip address 30.30.30.1
255.255.255.0
```

Enable label switching on an interface.

```
Qtech(config if gigabitEthernet 1/0)# label switching
```

The configuration of ASBR2 is similar to that of ASBR1.

3.4.9 Inter-AS VPN OptionC: RR Networking Scheme

In the two implementation modes of OptionC, another problem exists. If the sites of the same VPN user are located at different ASs, a common OptionC scheme requires full mesh BGP connections for the inter-AS PEs to ensure the connectivity of the VPN sites. As shown in the following figure, the sites of the VPN user are at three different ASs. If a new VPN site is added, the new site has to set up BGP connections with the other VPN sites. This restricts the application of the common OptionC scheme. To address the preceding expansion problem, you can add an RR to each AS in the OptionC scheme. The RRs set up multi-hop MP-EBGP connections to exchange inter-AS VPN routes. At the same time, you can set up MP-IBGP sessions between PEs and the RR in the AS.

Figure 33 Setting up multi-hop MP-EBGP sessions between RRs in the OptionC scheme

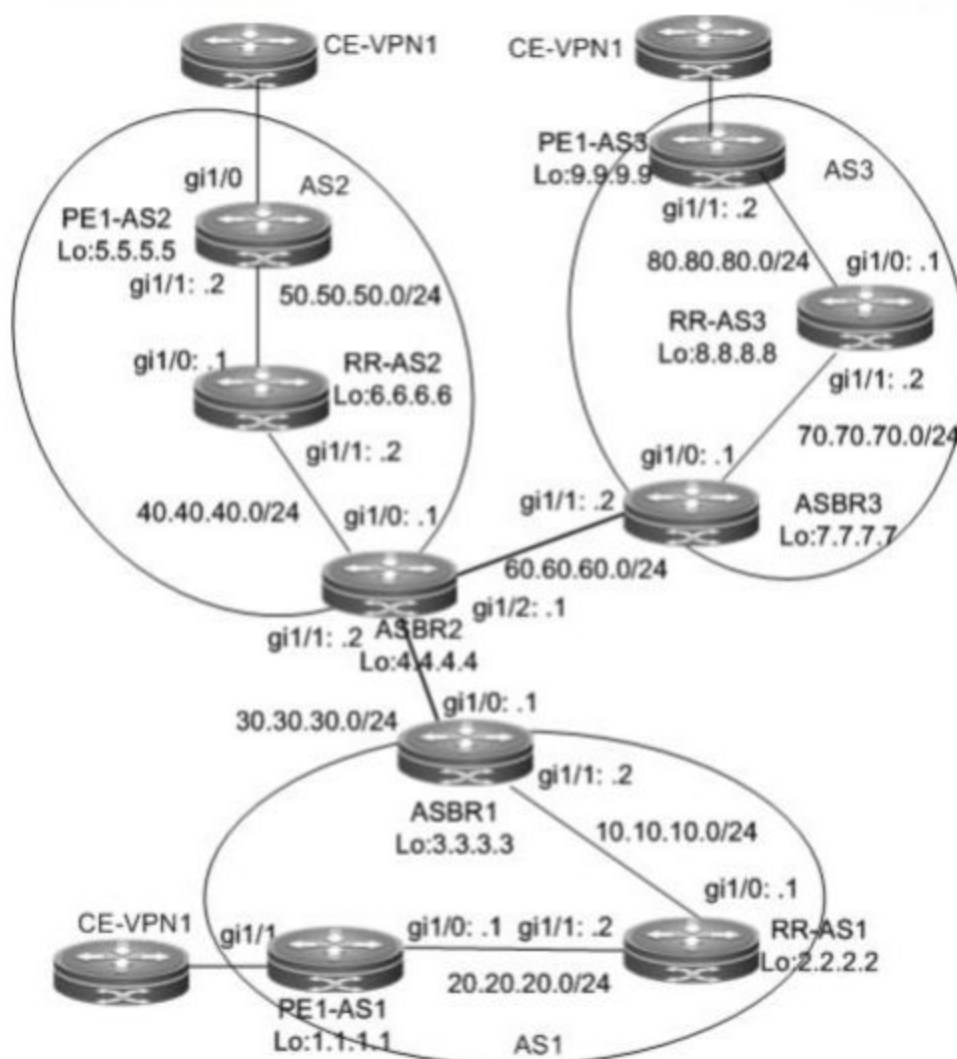

The configuration scheme is as follows:

PE1-AS1:

Configure the loopback interface.

```
Qtech# configure terminal
Qtech(config)# interface loopback 0
Qtech(config-if-Loopback 0)# ip address 1.1.1.1 255.255.255.255
```

Configure the VRF.

The configuration procedure is similar to that of PE1-AS1 in Inter AS VPN OptionB: Next Hop Unchanged and is not described here.

Set up an MP-IBGP session with the RR and enable label exchanging of IPv4 routes.

```
Qtech# configure terminal
Qtech(config)# router bgp 1
```

```
Qtech(config router)# neighbor 2.2.2.2 remote as 1
Qtech(config router)# neighbor 2.2.2.2 update source loopback 0
Qtech(config router)# address family vpv4 unicast
Qtech(config router af)# neighbor 2.2.2.2 activate
Qtech(config router af)# exit
Qtech(config router)# address family ipv4
Qtech(config router af)# neighbor 2.2.2.2 activate
Qtech(config router af)# neighbor 2.2.2.2 send label
Qtech(config router af)# end
```

Configure CE neighbors through EBGP.

Refer to the configuration procedure in *Running BGP Between a PE and CE to Transmit VPN Routes* and the related configurations in *Intranet Configuration Examples*.

The configurations of PE1-AS2 and PE1-AS3 are similar to that of PE1-AS1.

RR-AS1

Configure the loopback interface.

```
Qtech# configure terminal
Qtech(config)# interface loopback 0
Qtech(config if Loopback 0)# ip address 2.2.2.2 255.255.255.255
```

Set up an MP-IBGP session with the PE, specify the PE as the RR client, and enable label exchanging of IPv4 routes.

```
Qtech# configure terminal
Qtech(config)# router bgp 1
Qtech(config router)# neighbor 1.1.1.1 remote as 1
Qtech(config router)# neighbor 1.1.1.1 update source loopback 0
Qtech(config router)# address family vpv4 unicast
Qtech(config router af)# neighbor 1.1.1.1 activate
Qtech(config router af)# neighbor 1.1.1.1 route reflector client
Qtech(config router af)# exit
Qtech(config router)# address family ipv4
Qtech(config router af)# neighbor 1.1.1.1 activate
Qtech(config router af)# neighbor 1.1.1.1 send label
Qtech(config router af)# neighbor 1.1.1.1 route reflector client
Qtech(config router af)# end
```

Set up a multi-hop MP-EBGP session with the RR, do not modify the next hop of VPN routes exchanged with the RR, and disable the IPv4 route exchange with the RR.

```
Qtech# configure terminal
Qtech(config)# router bgp 1
Qtech(config router)# neighbor 6.6.6.6 remote as 2
Qtech(config router)# neighbor 6.6.6.6 update source loopback 0
```

```
Qtech(config router)# neighbor 6.6.6.6 ebgp multihop
Qtech(config router)# neighbor 8.8.8.8 remote as 3
Qtech(config router)# neighbor 8.8.8.8 update source loopback 0
Qtech(config router)# neighbor 8.8.8.8 ebgp multihop
Qtech(config router)# address family ipv4
Qtech(config router af)# no neighbor 6.6.6.6 activate
Qtech(config router af)# no neighbor 8.8.8.8 activate
Qtech(config router af)# exit address family
Qtech(config router)# address family vpnv4 unicast
Qtech(config router af)# neighbor 6.6.6.6 activate
Qtech(config router af)# neighbor 6.6.6.6 next hop unchanged
Qtech(config router af)# neighbor 8.8.8.8 activate
Qtech(config router af)# neighbor 8.8.8.8 next hop unchanged
Qtech(config router af)# end
```

Set up an IBGP session with the ASBR and enable IPv4 label switching.

```
Qtech# configure terminal
Qtech(config)# router bgp 1
Qtech(config router)# neighbor 3.3.3.3 remote as 1
Qtech(config router)# neighbor 3.3.3.3 update source loopback 0
Qtech(config router)# address family ipv4
Qtech(config router af)# neighbor 3.3.3.3 activate
Qtech(config router af)# neighbor 3.3.3.3 send label
Qtech(config router af)# end
```

Configure MPLS.

```
Qtech# configure terminal
Qtech(config)# mpls ip
Qtech(config)# mpls router ldp
Qtech(config mpls router)# ldp router id interface loopback 0 force
Qtech(config mpls router)# exit
Qtech(config)# interface gigabitethernet 1/1
```

Use the `no switchport` command to switch the port mode on the switch series to the Routed Port mode. This command is not applicable to routers.

```
Qtech(config if gigabitethernet 1/1)# no switchport
Qtech(config if gigabitethernet 1/1)# ip address 20.20.20.2
255.255.255.0
Qtech(config if gigabitethernet 1/1)# label switching
Qtech(config if gigabitethernet 1/1)# mpls ip
Qtech(config if gigabitethernet 1/1)# exit
Qtech(config)# interface gigabitethernet 1/0
```

Use the `no switchport` command to switch the port mode on the switch series to the Routed Port mode. This command is not applicable to routers.

```
Qtech(config if gigabitethernet 1/0)# no switchport
Qtech(config if gigabitethernet 1/0)# ip address 10.10.10.1
255.255.255.0
Qtech(config if gigabitethernet 1/0)# label switching
Qtech(config if gigabitethernet 1/0)# mpls ip
Qtech(config if gigabitethernet 1/0)# end
```

Run OSPF on the backbone network to transmit routing information.

```
Qtech# configure terminal
Qtech(config)# router ospf 10
Qtech(config router)# network 20.20.20.0 0.0.0.255 area 0
Qtech(config router)# network 2.2.2.2 0.0.0.0 area 0
Qtech(config router)# network 10.10.10.0 0.0.0.255 area 0
Qtech(config router)# end
```

The procedures of RR-AS2 and RR-AS3 are similar to the preceding procedure.

ASBR1:

Configure the loopback interface.

```
Qtech# configure terminal
Qtech(config)# interface loopback 0
Qtech(config if Loopback 0)# ip address 3.3.3.3 255.255.255.255
```

Configure ACL rules and route map rules.

```
Qtech# configure terminal
Qtech(config)# ip access list extended 101
Qtech(config ext nacl)# permit ip host 1.1.1.1 any
Qtech(config ext nacl)# exit
Qtech(config)# ip access list extended 102
Qtech(config ext nacl)# permit ip host 5.5.5.5 any
Qtech(config ext nacl)# permit ip host 9.9.9.9 any
Qtech(config ext nacl)# exit
Qtech(config)# route map internal mpls route permit 10
Qtech(config route map)# match ip address 101
Qtech(config route map)# set mpls label
Qtech(config route map)# exit
Qtech(config)# route map external mpls route permit 10
Qtech(config route map)# match ip address 102
Qtech(config route map)# set mpls label
Qtech(config route map)# end
```

Set up an EBGP session with the ASBR, enable label switching of IPv4 routes, and configure route map rules to assign labels to PE routes that match the rules (the route map rules are optional and allow the BGP to assign labels to only certain routes). Set up an IBGP session with the RR, enable

label switching of IPv4 routes, and configure route map rules to assign labels to inter-PE routes that match the rules. Configure static routes to the PEs in the local AS.

```
Qtech# configure terminal
Qtech(config)# router bgp 1
Qtech(config router)# neighbor 30.30.30.2 remote as 2
Qtech(config router)# neighbor 2.2.2.2 remote as 1
Qtech(config router)# neighbor 2.2.2.2 update source loopback 0
Qtech(config router)# address family ipv4
Qtech(config router af)# neighbor 30.30.30.2 send label
Qtech(config router af)# neighbor 30.30.30.2 route map internal mpls route out
Qtech(config router af)# neighbor 2.2.2.2 send label
Qtech(config router af)# neighbor 2.2.2.2 route map external mpls route out
Qtech(config router af)# network 1.1.1.1 mask 255.255.255.255
Qtech(config router af)# end
```

Configure MPLS signaling and enable MPLS on an interface.

```
Qtech# configure terminal
Qtech(config)# mpls ip
Qtech(config)# mpls router ldp
Qtech(config mpls router)# ldp router id interface loopback 0 force
Qtech(config mpls router)# exit
Qtech(config)# interface gigabitethernet 1/1
```

Use the `no switchport` command to switch the port mode on the switch series to the Routed Port mode. This command is not applicable to routers.

```
Qtech(config if Gigabitethernet 1/1)# no switchport
Qtech(config if Gigabitethernet 1/1)# ip address 10.10.10.2
255.255.255.0
Qtech(config if Gigabitethernet 1/1)# label switching
Qtech(config if Gigabitethernet 1/1)# mpls ip
Qtech(config if Gigabitethernet 1/1)# end
```

Run OSPF on the backbone network to transmit routing information.

```
Qtech# configure terminal
Qtech(config)# router ospf 10
Qtech(config router)# network 10.10.10.0 0.0.0.255 area 0
Qtech(config router)# network 3.3.3.3 0.0.0.0 area 0
Qtech(config router)# end
```

Assign an IP address to the interface connected to ASBR2.

```
Qtech(config)# interface gigabitethernet 1/0
```

Use the `no switchport` command to switch the port mode on the switch series to the Routed Port mode. This command is not applicable to routers.

```
Qtech(config if GigabitEthernet 1/0)# no switchport
```

```
Qtech(config if gigabitethernet 1/0)# ip address 30.30.30.1  
255.255.255.0
```

Enable label switching on an interface.

```
Qtech(config if gigabitethernet 1/0)# label switching
```

The configurations of ASBR2 and ASBR3 are similar to that of ASBR1.

3.4.10 CSC: Second Carrier provides Internet service based on IP core

Networking Requirements

A carrier owns a private network in City A, and this network has the BGP gateways to ISP A and ISP B. This carrier utilizes its private network to provide Internet service to users in City A. Currently, this carrier expects to expand service to City B, and therefore leases MPLS VPN service from VPN carrier in the hope of connecting two cities via VPN, so that users in City B can access Internet through the existing Internet gateways. The internal routes are exchanged via IGP (OSPF), and the external routes are exchanged via BGP.

Topology

Figure 34 Network topology of scenario I

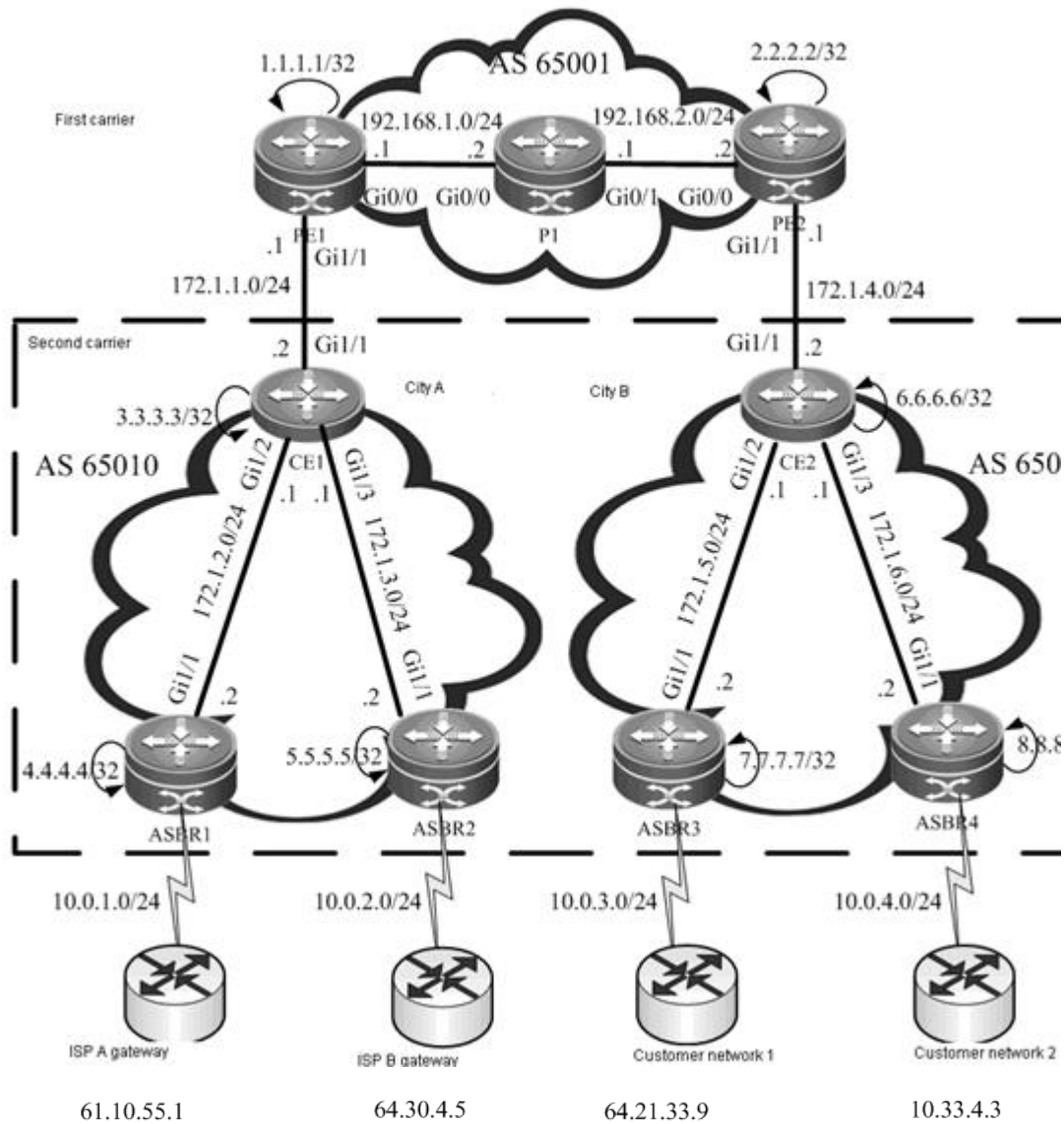

Notes

- ❖ Configure basic BGP/MPLS VPN for First Carrier
- ❖ Enable CSC function
- ❖ Configure Second Carrier
- ❖ Configure user access

Configuration Steps

- ❖ Configure basic BGP/MPLS VPN for First Carrier

Configure MPLS network: Here we will take PE1 as the example. The configurations of P1 and PE2 are the same.

Configure Loopback interface

```
Qttech(config)# interface Loopback 0
Qttech(config if)# ip address 1.1.1.1 255.255.255.255
Qttech(config if)# exit
```

Globally enable MPLS and LDP

```
Qttech(config)# mpls ip
Qttech(config)# mpls router ldp
Qttech(config mpls router)# ldp router id interface Loopback 0
Qttech(config mpls router)# exit
```

Enable MPLS and LDP on the interface

```
Qttech(config)# interface gigabitEthernet 0/0
```

In case of a switch, configure the interface to RoutedPort interface (not applicable to a router)

```
Qttech(config if)# no switchport
```

In case of a router, enable fast forwarding on the interface (not applicable to a switch)

```
Qttech(config if)# ip ref
Qttech(config if)# ip address 192.168.1.1 255.255.255.0
Qttech(config if)# label switching
Qttech(config if)# mpls ip
Qttech(config if)# no shutdown
Qttech(config if)# exit
```

Configure IGP (OSPF)

```
Qttech(config)# router ospf 1
Qttech(config router)# network 1.1.1.1 0.0.0.0 area 0
Qttech(config router)# network 192.168.1.0 0.0.0.255 area 0
Qttech(config router)# exit
```

Configure MP-IBGP neighbor: Here we will take PE1 as the example. The configurations of PE2 are the same.

```
Qttech(config)# router bgp 65001
Qttech(config router)# neighbor 2.2.2.2 remote as 65001
Qttech(config router)# neighbor 2.2.2.2 update source Loopback 0
Qttech(config router)# address family vpnv4
Qttech(config router af)# neighbor 2.2.2.2 activate
Qttech(config router af)# neighbor 2.2.2.2 send community both
```

Configure VRF: Here we will take PE1 as the example. The configurations of PE2 are the same.

```
Qttech(config)# ip vrf vpn1
Qttech(config vrf)# rd 65001:20
```

```
Qtech(config vrf)# route target both 65001:20
Qtech(config vrf)# alloc label per route
Qtech(config vrf)# exit
Qtech(config)# interface loopback 1
Qtech(config if)# ip vrf forwarding vpn1
Qtech(config if)# ip address 10.1.1.1 255.255.255.255
Qtech(config if)# no shutdown
Qtech(config if)# exit
Qtech(config)# interface gigabitEthernet 1/1
```

In case of a switch, configure the interface to RoutedPort interface (not applicable to a router)

```
Qtech(config if)# no switchport
```

In case of a router, enable fast forwarding on the interface (not applicable to a switch)

```
Qtech(config if)# ip ref
Qtech(config if)# ip vrf forwarding vpn1
Qtech(config if)# ip address 172.1.1.1 255.255.255.0
Qtech(config if)# no shutdown
```

Configure CE to connect with PE: Here we will take CE1 as the example. The configurations of CE2 are the same.

```
Qtech(config)# interface gigabitEthernet 1/1
```

In case of a switch, configure the interface to RoutedPort interface (not applicable to a router)

```
Qtech(config if)# no switchport
```

In case of a router, enable fast forwarding on the interface (not applicable to a switch)

```
Qtech(config if)# ip ref
Qtech(config if)# ip address 172.1.1.2 255.255.255.0
Qtech(config if)# no shutdown
```

Configure PE-CE route exchanging: Here we will take PE1-CE1 as the example. The configurations of PE2-CE2 are the same.

Configure on PE1:

```
Qtech(config)# router ospf 100 vrf vpn1
Qtech(config router)# network 172.1.1.0 0.0.0.255 area 0
Qtech(config router)# redistribute bgp 65001 subnets
Qtech(config router)# exit
Qtech(config)# router bgp 65001
Qtech(config router)# address family ipv4 vrf vpn1
Qtech(config router af)# redistribute ospf 100 vrf vpn1
Qtech(config router af)# exit
Qtech(config router)# exit
```

Use then, configure on CE1:

```
Qtech(config)# router ospf 1
```

```
Qtech(config router)# network 172.1.1.0 0.0.0.255 area 0
Qtech(config router)# exit
```

❖ Enable CSC function

Enable CSC on PE: Here we will take PE1 as the example. The configurations of PE2 are the same.

```
Qtech(config)# mpls router ldp vpn1
Qtech(config mpls router)# ldp rouer id interface Loopback 1
Qtech(config mpls router)# advertise labels for bgp routes
Qtech(config mpls router)# exit
Qtech(config)# interface gigabitEthernet 1/1
```

In case of a switch, configure the interface to RoutedPort interface (not applicable to a router)

```
Qtech(config if)# no switchport
```

In case of a router, enable fast forwarding on the interface (not applicable to a switch)

```
Qtech(config if)# ip ref
Qtech(config if)# label switching
Qtech(config if)# mpls ip
```

Enable MPLS and LDP on CE: Here we will take CE1 as the example. The configurations of CE2 are the same.

```
Qtech(config)# mpls ip
Qtech(config)# mpls router ldp
Qtech(config mpls router)# ldp rouer id interface Loopback 0
Qtech(config mpls router)# exit
Qtech(config)# interface gigabitEthernet 1/1
```

In case of a switch, configure the interface to RoutedPort interface (not applicable to a router)

```
Qtech(config if)# no switchport
```

In case of a router, enable fast forwarding on the interface (not applicable to a switch)

```
Qtech(config if)# ip ref
Qtech(config if)# label switching
Qtech(config if)# mpls ip
```

❖ Configure Second Carrier

Configure interface and IGP: Here we will take CE1 as the example. The configurations of CE2, ASBR1, ASBR2, ASBR3 and ASBR4 are the same.

```
Qtech(config)# interface gigabitEthernet 1/2
```

In case of a switch, configure the interface to RoutedPort interface (not applicable to a router)

```
Qtech(config if)# no switchport
```

In case of a router, enable fast forwarding on the interface (not applicable to a switch)

```
Qtech(config if)# ip ref
```

```
Qtech(config if)# ip address 172.1.2.1 255.255.255.0
Qtech(config if)# no shutdown
Qtech(config if)# exit
Qtech(config)# interface gigabitEthernet 1/3
```

In case of a switch, configure the interface to RoutedPort interface (not applicable to a router)

```
Qtech(config if)# no switchport
```

In case of a router, enable fast forwarding on the interface (not applicable to a switch)

```
Qtech(config if)# ip ref
Qtech(config if)# ip address 172.1.3.1 255.255.255.0
Qtech(config if)# no shutdown
Qtech(config if)# exit
Qtech(config)# interface Loopback 0
Qtech(config if)# ip address 3.3.3.3 255.255.255.255
Qtech(config if)# exit
Qtech(config)# router ospf 1
Qtech(config router)# network 3.3.3.3 0.0.0.0 area 0
Qtech(config router)# network 172.1.2.0 0.0.0.255 area 0
Qtech(config router)# network 172.1.3.0 0.0.0.255 area 0
Qtech(config router)# exit
```

On ASBR, configure CE as the BGP neighbor: Here we will take ASBR1 as the example. The configurations of ASBR2, ASBR3 and ASBR4 are the same.

```
Qtech(config)# router bgp 65010
Qtech(config router)# neighbor 3.3.3.3 remote as 65010
Qtech(config router)# neighbor 3.3.3.3 update source Loopback 0
Qtech(config router)# neighbor 3.3.3.3 next hop self
```

On CE, configure ASBR and peer site PE as the route reflector client: Here we will take CE1 as the example. The configurations of CE2 are the same.

```
Qtech(config)# router bgp 65010
Qtech(config router)# neighbor 4.4.4.4 remote as 65010
Qtech(config router)# neighbor 4.4.4.4 update source Loopback 0
Qtech(config router)# neighbor 4.4.4.4 route reflector client
Qtech(config router)# neighbor 5.5.5.5 remote as 65010
Qtech(config router)# neighbor 5.5.5.5 update source Loopback 0
Qtech(config router)# neighbor 5.5.5.5 route reflector client
Qtech(config router)# neighbor 6.6.6.6 remote as 65010
Qtech(config router)# neighbor 6.6.6.6 update source Loopback 0
Qtech(config router)# neighbor 6.6.6.6 route reflector client
Qtech(config router)# exit
Qtech(config)# recursive route lookup lsp
```

❖ **Configure user access**

Here we will connect user network 1 with ASBR3. The configurations of other external networks (user network and Internet gateway) are the same.

On ASBR3

```
Qtech(config)# interface gigabitEthernet 1/2
```

In case of a switch, configure the interface to RoutedPort interface (not applicable to a router)

```
Qtech(config if)# no switchport
```

In case of a router, enable fast forwarding on the interface (not applicable to a switch)

```
Qtech(config if)# ip ref
```

```
Qtech(config if)# ip address 10.0.3.1 255.255.255.0
```

```
Qtech(config if)# no shutdown
```

```
Qtech(config if)# exit
```

```
Qtech(config)# router bgp 65010
```

```
Qtech(config router)# neighbor 10.0.3.2 remote as 100
```

```
Qtech(config router)# exit
```

On the edge router of user network 1

```
Qtech(config)# interface gigabitEthernet 0/0
```

In case of a switch, configure the interface to RoutedPort interface (not applicable to a router)

```
Qtech(config if)# no switchport
```

In case of a router, enable fast forwarding on the interface (not applicable to a switch)

```
Qtech(config if)# ip ref
```

```
Qtech(config if)# ip address 10.0.3.2 255.255.255.0
```

```
Qtech(config if)# no shutdown
```

```
Qtech(config if)# exit
```

```
Qtech(config)# interface gigabitEthernet 0/1
```

In case of a switch, configure the interface to RoutedPort interface (not applicable to a router)

```
Qtech(config if)# no switchport
```

In case of a router, enable fast forwarding on the interface (not applicable to a switch)

```
Qtech(config if)# ip ref
```

```
Qtech(config if)# ip address 64.21.33.9 255.255.255.0
```

```
Qtech(config if)# no shutdown
```

```
Qtech(config if)# exit
```

```
Qtech(config)# router bgp 100
```

```
Qtech(config router)# neighbor 10.0.3.1 remote as 65010
```

```
Qtech(config router)# network 64.21.33.0 mask 255.255.255.0
```

Verification

Display VRF routes and labels on PE: Here we will take PE1 as the example. The configurations of PE2 are the same.

// In the VRF routing table of PE, there are only internal routes of the Second Carrier. There is no external route (i.e.: 64.30.4.0/24).

```
Qtech# show ip route vrf vpn1
Routing Table: vpn1

Codes: C    connected, S    static, R    RIP, B    BGP
       O    OSPF, IA    OSPF inter area
       N1   OSPF NSSA external type 1, N2   OSPF NSSA external type 2
       E1   OSPF external type 1, E2   OSPF external type 2
       i    IS IS, su    IS IS summary, L1   IS IS level 1, L2   IS IS level 2
       ia   IS IS inter area, *    candidate default

Gateway of last resort is no set
O   3.3.3.3/32 [110/11] via 172.1.1.2, 00:00:07, gigabitEthernet 1/1
C   172.1.1.0/24 is directly connected, gigabitEthernet 1/1
C   172.1.1.1/32 is local host.
O   172.1.2.0/24 [110/12] via 172.1.1.2, 00:00:07, gigabitEthernet 1/1
B   172.1.4.0/24 [200/0] via 2.2.2.2, 00:00:30
.....
Qtech# show mpls ldp bindings vrf vpn1
VRF vpn1(id 1)
  lib entry: 3.3.3.3/32
    local binding: to lsr: 172.1.1.2:0, label: 1025
    remote binding: from lsr: 172.1.1.2:0, label: imp null
  lib entry: 172.1.1.0/24
    local binding: to lsr: 172.1.1.2:0, label: imp null
    remote binding: from lsr: 172.1.1.2:0, label: imp null
  lib entry 172.1.2.0/24
    local binding: to lsr: 172.1.1.2:0, label: 1026
    remote binding: from lsr: 172.1.1.2:0, label: 1024
.....
```

In ASBR and user network, display the routing table

// On ASBR, there are both external routes and internal routes (taking ASBR3 as the example)

```
Qtech# show ip route
Codes: C    connected, S    static, R    RIP, B    BGP
       O    OSPF, IA    OSPF inter area
       N1   OSPF NSSA external type 1, N2   OSPF NSSA external type 2
       E1   OSPF external type 1, E2   OSPF external type 2
       i    IS IS, su    IS IS summary, L1   IS IS level 1, L2   IS IS level 2
```

```
ia IS IS inter area, * candidate default
```

```
Gateway of last resort is no set
```

```
.....
```

```
O 3.3.3.3/24 [110/12] via 172.1.5.1, 00:00:30, gigabitEthernet 1/1
```

```
B 61.10.55.0/24 [200/0] via 3.3.3.3, 00:00:40
```

```
B 64.21.33.0/24 [200/0] via 10.0.3.2, 00:00:31
```

```
.....
```

// In the user network, there are external routes (taking the edge device of user network 1 as the example)

```
Qtech# show ip route
```

```
Qtech# show ip route
```

```
Codes: C connected, S static, R RIP, B BGP
```

```
O OSPF, IA OSPF inter area
```

```
N1 OSPF NSSA external type 1, N2 OSPF NSSA external type 2
```

```
E1 OSPF external type 1, E2 OSPF external type 2
```

```
i IS IS, su IS IS summary, L1 IS IS level 1, L2 IS IS level 2
```

```
ia IS IS inter area, * candidate default
```

```
Gateway of last resort is no set
```

```
.....
```

```
B 61.10.55.0/24 [200/0] via 10.0.3.1, 00:00:40
```

```
C 64.21.33.0/24 is directly connected, gigabitEthernet 0/1
```

```
C 64.21.33.9/32 is local host.
```

```
.....
```

Verify that the external networks are interconnected

// On the edge device of user network 1

```
Qtech# ping 61.10.55.1 source 64.21.33.9
```

```
Sending 5, 100 byte ICMP Echoes to 61.10.55.1, timeout is 2 seconds:
```

```
Packet sent with a source address of 64.21.33.9
```

```
< press Ctrl+C to break >
```

```
!!!!!
```

3.4.11 CSC: Second Carrier provides Internet service based on MPLS core

Networking Requirements

A carrier is providing Internet service for users in City A. Considering that it may need to provide MPLS service for users in the future, this carrier has deployed MPLS on its backbone network. Now this carrier intends to expand its service to City B, and has built MPLS network in City B. To interconnect the core networks in two cities, this carrier leases the VPN service from another MPLS VPN service provider. Therefore, this carrier has become a Second Carrier, while the MPLS VPN service provider is the First Carrier.

The First Carrier PE and Second Carrier CE will exchange (internal) routes via BGP. The Second Carrier will directly establish BGP neighbors between ASBRs to exchange external routes. The traffic will flow from the external network into the Second Carrier network and be forwarded on the tunnel until the traffic leaves the Second Carrier network.

Topology

Figure 35 Network topology of scenario II

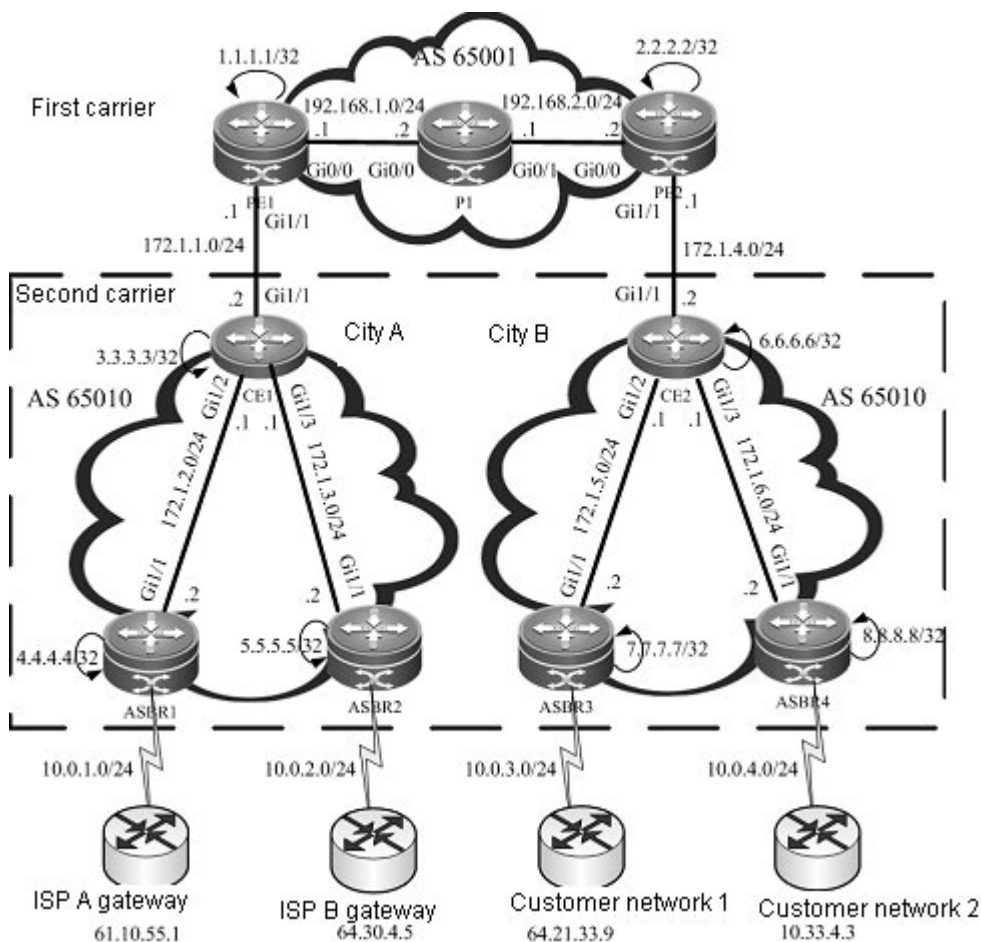

Notes

- ❖ Configure basic BGP/MPLS VPN for First Carrier
- ❖ Enable CSC function
- ❖ Configure Second Carrier
- ❖ Configure user access

Configuration Steps

- ❖ Configure basic BGP/MPLS VPN for First Carrier

The configuration steps are the same as Scenario I. The difference is that routes are exchanged between PE and CE. Only PE-CE route exchanging configurations will be shown below. For other

configurations, please refer to the section of "Configuring Basic BGP/MPLS VPN Functions" for the example of "Second Carrier provides Internet service based on IP core".

Configure route exchanging between PE and CE

Configure on PE (taking PE1 as the example)

```
Qtech(config)# router bgp 65001
Qtech(config router)# address family ipv4 vrf vpn1
Qtech(config router af)# neighbor 172.1.1.2 remote as 65010
Qtech(config router af)# neighbor 172.1.1.2 as override
Qtech(config router af)# exit
Qtech(config router)# exit
```

Use then, configure on CE (taking CE1 as the example)

```
Qtech(config)# router bgp 65010
Qtech(config router)# neighbor 172.1.1.2 remote as 65001
Qtech(config router)# redistribute ospf 1
Qtech(config router)# exit
Qtech(config)# router ospf 1
Qtech(config router)# redistribute bgp 65010 subnets
Qtech(config router)# exit
```

❖ **Enable CSC function**

Enable CSC on PE: Here we will take PE1 as the example. The configurations of PE2 are the same.

```
Qtech(config)# interface gigabitEthernet 1/1
```

In case of a switch, configure the interface to RoutedPort interface (not applicable to a router)

```
Qtech(config if)# no switchport
```

In case of a router, enable fast forwarding on the interface (not applicable to a switch)

```
Qtech(config if)# ip ref
Qtech(config if)# ip vrf forwarding vpn1
Qtech(config if)# ip address 172.1.1.1 255.255.255.0
Qtech(config if)# no shutdown
Qtech(config if)# exit
Qtech(config)# router bgp 65001
Qtech(config router)# address family ipv4 vrf vpn1
Qtech(config router af)# neighbor 172.1.1.2 send label
Qtech(config router af)# exit
Qtech(config router)# exit
```

Enable MPLS and BGP label distribution on CE

```
Qtech(config)# interface gigabitEthernet 1/1
```

In case of a switch, configure the interface to RoutedPort interface (not applicable to a router)

```
Qtech(config if)# no switchport
```

In case of a router, enable fast forwarding on the interface (not applicable to a switch)

```
Qtech(config if)# ip ref
Qtech(config if)# label switching
Qtech(config if)# ip address 172.1.1.2 255.255.255.0
Qtech(config if)# no shutdown
Qtech(config if)# exit
Qtech(config)# router bgp 65010
Qtech(config router)# neighbor 172.1.1.1 send label
Qtech(config router)# exit
```

❖ Configure Second Carrier

Configure MPLS network: Please refer to the section of "Configure MPLS Network" for the example of "Second Carrier provides Internet service based on IP core". Configuration objects are CE1, CE2 and ASBRs (1-4).



Note

You need to enable LDP on CSC-CE in order to establish sessions with other intra-site devices in order to build MPLS network. If CSC-CE and CSC-PE use BGP to exchange routes, then you must execute "advertise-labels for bgp-routes" on CSC-CE to allow LDP to distribute labels for BGP routes.

Configure BGP neighbor: Establish BGP adjacency between two ASBRs.

Configure ASBR2 as the BGP neighbor on ASBR1. The configurations of other ASBRs are the same.

```
Qtech(config)# router bgp 65010
Qtech(config router)# neighbor 5.5.5.5 remote as 65010
Qtech(config router)# neighbor 5.5.5.5 update source Loopback 0
Qtech(config router)# neighbor 5.5.5.5 next hop self
Qtech(config router)# exit
Qtech(config)# recursive route lookup lsp
```

❖ Configure user access

Please refer to the section of "Configure user access" for the example of "Second Carrier provides Internet service based on IP core".

Verification

Display VRF routes and labels on First Carrier PE: Here we will take PE1 as the example. The configurations of PE2 are the same.

// In the VRF routing table of PE1, there are only internal routes of the Second Carrier. There is no external routes (i.e.: 64.30.4.0/24).

```
Qttech# show ip route vrf vpn1
```

```
Routing Table: vpn1
```

```
Codes: C    connected, S    static, R    RIP, B    BGP
        O    OSPF, IA    OSPF inter area
        N1   OSPF NSSA external type 1, N2   OSPF NSSA external type 2
        E1   OSPF external type 1, E2   OSPF external type 2
        i    IS IS, su    IS IS summary, L1   IS IS level 1, L2   IS IS level 2
        ia   IS IS inter area, *    candidate default
```

```
Gateway of last resort is no set
```

```
B    3.3.3.3/32 [200/0] via 172.1.1.2, 00:00:07
C    172.1.1.0/24 is directly connected, gigabitEthernet 1/1
C    172.1.1.1/32 is local host.
B    172.1.2.0/24 [200/0] via 172.1.1.2, 00:00:07
B    172.1.4.0/24 [200/0] via 2.2.2.2, 00:00:30
```

```
.....
```

```
Qttech# show bgp vpnv4 unicast vrf vpn1 labels
```

```
BGP table version is 1, local router ID is 1.1.1.1
```

```
Status codes: s suppressed, d damped, h history, * valid, > best, i    internal,
                S Stale
```

```
Origin codes: i    IGP, e    EGP, ?    incomplete
```

```
      Network          Next Hop          In Label/Out Label
Route Distinguisher: 65001:20 (Default for VRF vpn1)
*> 3.3.3.3/32          172.1.1.2          2048/1024
*> 172.1.2.0/24        172.1.1.2          2049/1025
*>i6.6.6.6/32          2.2.2.2            2050/2112
```

```
.....
```

In ASBR and user network, display the routing table

// On ASBR (taking ASBR3 as the example)

```
Qttech# show ip route
```

```
Codes: C    connected, S    static, R    RIP, B    BGP
        O    OSPF, IA    OSPF inter area
        N1   OSPF NSSA external type 1, N2   OSPF NSSA external type 2
        E1   OSPF external type 1, E2   OSPF external type 2
        i    IS IS, su    IS IS summary, L1   IS IS level 1, L2   IS IS level 2
        ia   IS IS inter area, *    candidate default
```

```
Gateway of last resort is no set
```

```
.....
```

```
B    61.10.55.0/24 [200/0] via 4.4.4.4, 00:00:40
```

```
B 64.21.33.0/24 [200/0] via 10.0.3.2, 00:00:31
.....
```

// In the user network, we will take the edge device of user network 1 as the example

```
Qttech# show ip route
Codes: C    connected, S    static, R    RIP, B    BGP
       O    OSPF, IA    OSPF inter area
       N1   OSPF NSSA external type 1, N2   OSPF NSSA external type 2
       E1   OSPF external type 1, E2   OSPF external type 2
       i    IS IS, su    IS IS summary, L1   IS IS level 1, L2   IS IS level 2
       ia   IS IS inter area, *    candidate default

Gateway of last resort is no set
.....
B 61.10.55.0/24 [200/0] via 10.0.3.1, 00:00:40
C 64.21.33.0/24 is directly connected, gigabitEthernet 0/1
C 64.21.33.9/32 is local host.
.....
```

Verify that the external networks are interconnected

// On the edge device of user network 1

```
Qttech# ping 61.10.55.1 source 64.21.33.9
Sending 5, 100 byte ICMP Echoes to 61.10.55.1, timeout is 2 seconds:
 < press Ctrl+C to break >
!!!!
Success rate is 100 percent (5/5), round trip min/avg/max = 10/20/40 ms
```

3.4.12 CSC: Second Carrier provides VPN service based on MPLS core

Networking Requirements

A carrier owns MPLS core network in City A and provides MPLS VPN service for users in this city. Now this carrier intends to expand service to City B, and has built MPLS core network in City B. In order to interconnect the core networks in these two cities, this carrier leases the VPN service from another MPLS VPN service provider, and thus forming the networking model of "Carrier's Carrier".

The First Carrier PE and Second Carrier CE will exchange (internal) routes via BGP. MP-IBGP neighbor is established between Second Carrier PEs to exchange user VPN routes. OSPF is deployed between Second Carrier PE and user VPN CE to exchange routes.

Topology

Figure 36 MPLS core second-level VPN provider

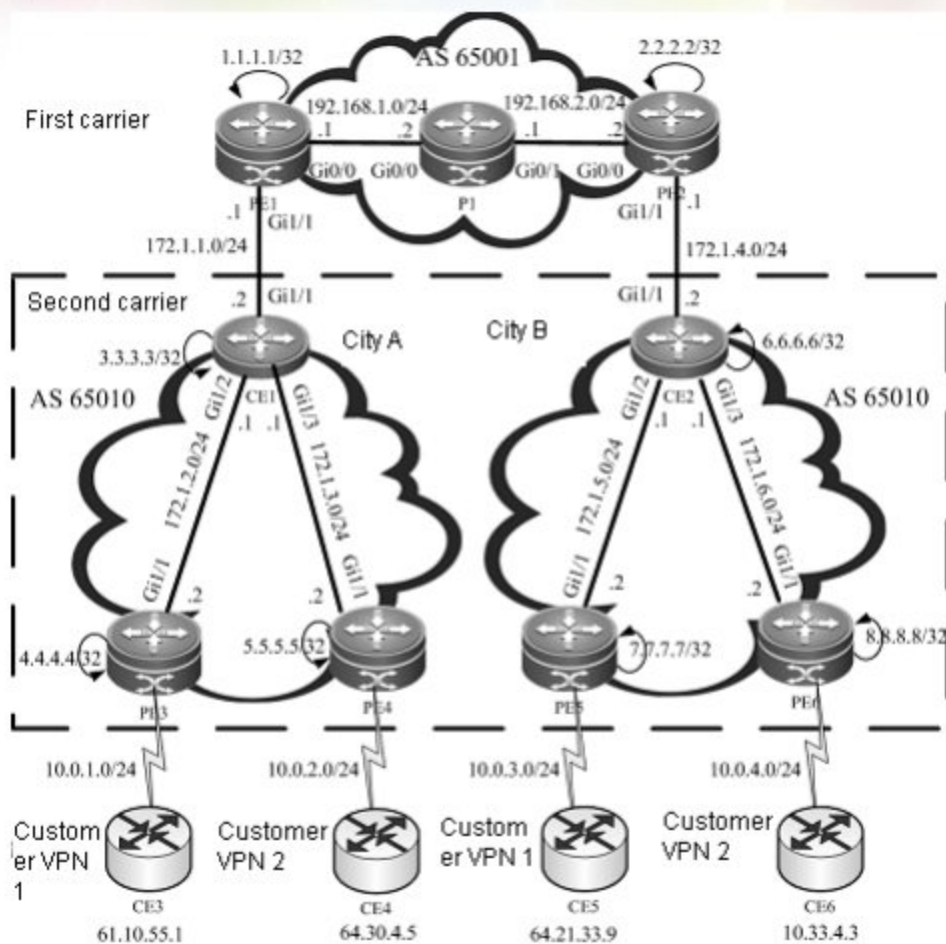

Notes

- ❖ Configure basic BGP/MPLS VPN for First Carrier
- ❖ Enable CSC function
- ❖ Configure Second Carrier
- ❖ Configure user access

Configuration Steps

- ❖ Configure basic BGP/MPLS VPN for First Carrier

Please refer to the section of "Configuring Basic BGP/MPLS VPN Functions" for the example of "Second Carrier provides Internet service based on MPLS core".

- ❖ Enable CSC function

Please refer to the section of "Enable CSC Function" for the example of "Second Carrier provides Internet service based on MPLS core".

- ❖ Configure Second Carrier

Configure MPLS network: Please refer to the section of "Configure MPLS Network" for the example of "Second Carrier provides Internet service based on IP core". Configuration objects are CE1, CE2 and PEs (3-6).



Note You need to enable LDP on CSC-CE in order to establish sessions with other intra-site devices in order to build MPLS network. If CSC-CE and CSC-PE use BGP to exchange routes, then you must execute "advertise-labels for bgp-routes" on CSC-CE to allow LDP to distribute labels for BGP routes.

Configure MP-IBGP neighbor: Please refer to the section of "Configure MP-IBGP Neighbor" for the example of "Second Carrier provides Internet service based on IP core". Configure the MP-IBGP adjacencies between PE3, PE4, PE5 and PE6.

❖ Configure user access

The configurations of this section involve VRF configuration, PE-CE route exchanging configuration and etc. These configurations are the same as that of BGP/MPLS VPN. Here we will connect CE3 with PE3.

On PE3

```
Qtech(config)# ip vrf customer_vpn1
Qtech(config vrf)# rd 65010:1
Qtech(config vrf)# route target both 65010:1
Qtech(config vrf)# exit
Qtech(config)# interface gigabitEthernet 1/2
```

In case of a switch, configure the interface to RoutedPort interface (not applicable to a router)

```
Qtech(config if)# no switchport
```

In case of a router, enable MPLS fast forwarding on the interface (not applicable to a switch)

```
Qtech(config if)# ip ref
Qtech(config if)# ip vrf forwarding customer_vpn1
Qtech(config if)# ip address 10.0.1.1 255.255.255.0
Qtech(config if)# no shutdown
Qtech(config if)# exit
Qtech(config)# router ospf 10 vrf customer_vpn1
Qtech(config router)# network 10.0.1.0 0.0.0.255 area 0
Qtech(config router)# redistribute bgp 65010 subnets
Qtech(config router)# exit
Qtech(config)# router bgp 65010
Qtech(config router)# address family ipv4 vrf customer_vpn1
Qtech(config router af)# redistribute ospf 10 vrf customer_vpn1
Qtech(config router af)# exit
```

```
Qtech(config router)# exit
```

On CE3

```
Qtech(config)# interface gigabitEthernet 0/0
```

In case of a switch, configure the interface to RoutedPort interface (not applicable to a router)

```
Qtech(config if)# no switchport
```

In case of a router, enable fast forwarding on the interface (not applicable to a switch)

```
Qtech(config if)# ip ref
```

```
Qtech(config if)# ip address 10.0.1.2 255.255.255.0
```

```
Qtech(config if)# no shutdown
```

```
Qtech(config)# interface gigabitEthernet 0/1
```

In case of a switch, configure the interface to RoutedPort interface (not applicable to a router)

```
Qtech(config if)# no switchport
```

In case of a router, enable fast forwarding on the interface (not applicable to a switch)

```
Qtech(config if)# ip ref
```

```
Qtech(config if)# ip address 61.10.55.1 255.255.255.0
```

```
Qtech(config if)# no shutdown
```

```
Qtech(config if)# exit
```

```
Qtech(config)# router ospf 1
```

```
Qtech(config router)# network 10.0.1.0 0.0.0.255 area 0
```

```
Qtech(config router)# network 61.10.55.0 0.0.0.255 area 0
```

```
Qtech(config router)# exit
```

Verification

Display VRF routes and labels on First Carrier PE: Here we will take PE1 as the example. The configurations of PE2 are the same.

// In the VRF routing table of PE1, there are only internal routes of the Second Carrier. There is no VPN route (i.e.: 64.30.4.0/24).

```
Qtech# show ip route vrf vpn1
```

```
Routing Table: vpn1
```

```
Codes: C    connected, S    static, R    RIP, B    BGP
```

```
        O    OSPF, IA    OSPF inter area
```

```
        N1   OSPF NSSA external type 1, N2   OSPF NSSA external type 2
```

```
        E1   OSPF external type 1, E2   OSPF external type 2
```

```
        i    IS IS, su    IS IS summary, L1   IS IS level 1, L2   IS IS level 2
```

```
        ia   IS IS inter area, *    candidate default
```

```
Gateway of last resort is no set
```

```
B    3.3.3.3/32 [200/0] via 172.1.1.2, 00:00:07
```

```

C 172.1.1.0/24 is directly connected, gigabitEthernet 1/1
C 172.1.1.1/32 is local host.
B 172.1.2.0/24 [200/0] via 172.1.1.2, 00:00:07
B 172.1.4.0/24 [200/0] via 2.2.2.2, 00:00:30
.....
Qtech# show bgp vpnv4 unicast vrf vpn1 labels
BGP table version is 1, local router ID is 1.1.1.1
Status codes: s suppressed, d damped, h history, * valid, > best, i internal,
               S Stale
Origin codes: i IGP, e EGP, ? incomplete

   Network          Next Hop          In Label/Out Label
Route Distinguisher: 65001:20 (Default for VRF vpn1)
*> 3.3.3.3/32       172.1.1.2         2048/1024
*> 172.1.2.0/24     172.1.1.2         2049/1025
*>i6.6.6.6/32      2.2.2.2           2050/2112
.....

```

In the VRF of Second Carrier PE and user VPN CE, display the routing table.

// On PE (taking PE3 as the example)

```

Qtech# show ip route vrf customer_vpn1
Routing Table: customer_vpn1

Codes: C connected, S static, R RIP, B BGP
       O OSPF, IA OSPF inter area
       N1 OSPF NSSA external type 1, N2 OSPF NSSA external type 2
       E1 OSPF external type 1, E2 OSPF external type 2
       i IS IS, su IS IS summary, L1 IS IS level 1, L2 IS IS level 2
       ia IS IS inter area, * candidate default

Gateway of last resort is no set
.....
O 61.10.55.0/24 [200/0] via 10.0.1.2, 00:00:40, gigabitEthernet 1/2
B 64.21.33.0/24 [200/0] via 7.7.7.7, 00:00:31
.....

```

// In user VPN CE (taking CE3 as the example)

```

Qtech# show ip route
Codes: C connected, S static, R RIP, B BGP
       O OSPF, IA OSPF inter area
       N1 OSPF NSSA external type 1, N2 OSPF NSSA external type 2
       E1 OSPF external type 1, E2 OSPF external type 2
       i IS IS, su IS IS summary, L1 IS IS level 1, L2 IS IS level 2
       ia IS IS inter area, * candidate default

```



```
Gateway of last resort is no set
.....
C 61.10.55.0/24 is directly connected, gigabitEthernet
C 61.10.55.1/32 is local host.
O 64.21.33.0/24 [200/0] via 10.0.1.1, 00:00:42, gigabitEthernet 0/0
.....
```

Verify that the user VPN networks are interconnected

//On CE3

```
Qtch# ping 64.21.33.9
Sending 5, 100 byte ICMP Echoes to 64.21.33.9, timeout is 2 seconds:
 < press Ctrl+C to break >
!!!!
Success rate is 100 percent (5/5), round trip min/avg/max = 10/20/40 ms
```

3.4.13 MPLS VPN over GRE

Networking Requirements

In an IP core network, the edge router of PE supports MPLS VPN. Now it is required to use "MPLS VPN over GRE" to use the IP core network to provide MPLS VPN service for users. The IP core network adopts dual OSPF instances to introduce VPN traffic into the GRE tunnel, while PE and CE exchange routes via OSPF.

Topology

Figure 37 Network topology

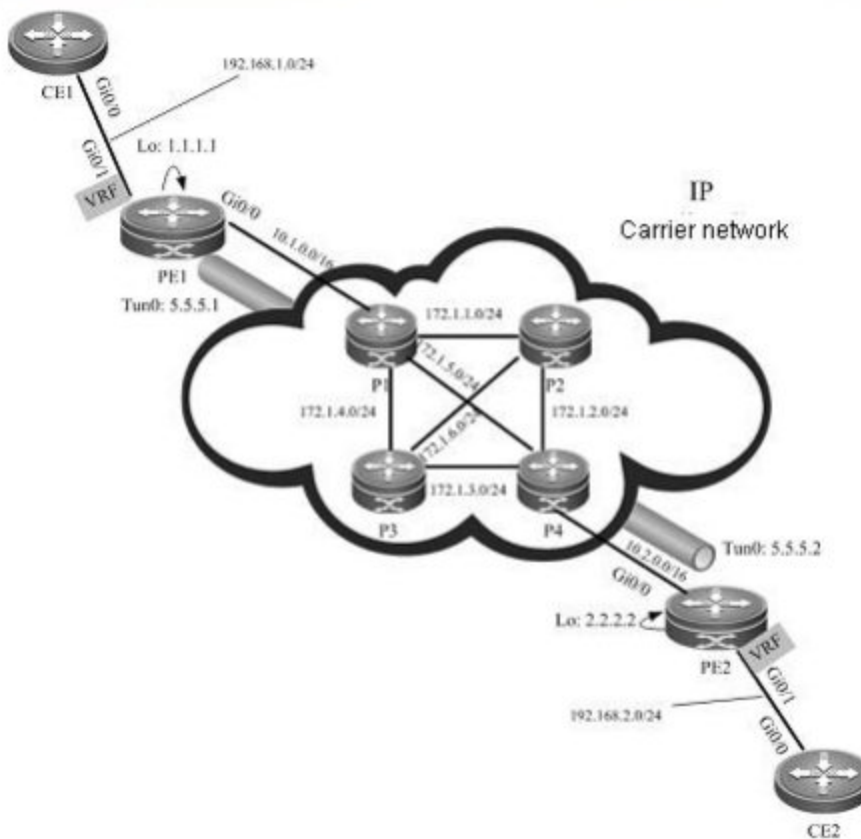

Notes

- ❖ Create GRE tunnel
- ❖ Configure IGP route
- ❖ Configure MPLS network
- ❖ Configure MPLS VPN

Configuration Steps

- ❖ Configure P device. Here we will take P1 as the example. The configurations of other devices are the same.

Configure interface and IP address

```
Qttech(config)# interface gigabitEthernet 0/0
```

In case of a switch, configure the interface to RoutedPort interface (not applicable to a router)

```
Qttech(config-if)# no switchport
```

In case of a router, enable fast forwarding on the interface (not applicable to a switch)

```
Qttech(config-if)# ip ref
```

```
Qttech(config-if)# ip address 10.1.0.2 255.255.0.0
```

```
Qttech(config-if)# no shutdown
```

```
Qtech(config if)# exit
```

```
Qtech(config)# interface gigabitEthernet 0/1
```

In case of a switch, configure the interface to RoutedPort interface (not applicable to a router)

```
Qtech(config if)# no switchport
```

In case of a router, enable fast forwarding on the interface (not applicable to a switch)

```
Qtech(config if)# ip ref
```

```
Qtech(config if)# ip address 172.1.1.1 255.255.255.0
```

```
Qtech(config if)# no shutdown
```

```
Qtech(config if)# exit
```

```
Qtech(config)# interface gigabitEthernet 1/1
```

In case of a switch, configure the interface to RoutedPort interface (not applicable to a router)

```
Qtech(config if)# no switchport
```

In case of a router, enable fast forwarding on the interface (not applicable to a switch)

```
Qtech(config if)# ip ref
```

```
Qtech(config if)# ip address 172.1.5.1 255.255.255.0
```

```
Qtech(config if)# no shutdown
```

```
Qtech(config if)# exit
```

```
Qtech(config)# interface gigabitEthernet 0/3
```

In case of a switch, configure the interface to RoutedPort interface (not applicable to a router)

```
Qtech(config if)# no switchport
```

In case of a router, enable fast forwarding on the interface (not applicable to a switch)

```
Qtech(config if)# ip ref
```

```
Qtech(config if)# ip address 172.1.4.1 255.255.255.0
```

```
Qtech(config if)# no shutdown
```

```
Qtech(config if)# exit
```

Configure IGP routing instance

```
Qtech(config)# router ospf 1
```

```
Qtech(config router)# network 172.1.1.0 0.0.0.255 area 0
```

```
Qtech(config router)# network 172.1.5.0 0.0.0.255 area 0
```

```
Qtech(config router)# network 172.1.4.0 0.0.0.255 area 0
```

```
Qtech(config router)# network 10.1.0.0 0.0.255.255 area 0
```

```
Qtech(config router)# exit
```

❖ **Configure PE device. Here we will take PE1 as the example. The configurations of other devices are the same.**

Configure public-network interface and IP address

```
Qtech(config)# interface Loopback 0
```

```
Qtech(config if)# ip address 1.1.1.1 255.255.255.255
```

```
Qtech(config if)# exit
```

```
Qtech(config)# interface gigabitEthernet 0/0
```

In case of a switch, configure the interface to RoutedPort interface (not applicable to a router)

```
Qtech(config if)# no switchport
```

In case of a router, enable fast forwarding on the interface (not applicable to a switch)

```
Qtech(config if)# ip ref
```

```
Qtech(config if)# ip address 10.1.0.1 255.255.0.0
```

```
Qtech(config if)# no shutdown
```

```
Qtech(config if)# exit
```

Create GRE tunnel

```
Qtech(config)# interface tunnel 0
```

```
Qtech(config if)# ip address 5.5.5.1 255.255.255.0
```

```
Qtech(config if)# tunnel mode gre ip
```

```
Qtech(config if)# tunnel source 10.1.0.1
```

```
Qtech(config if)# tunnel destination 10.2.0.1
```

```
Qtech(config if)# exit
```

Configure IGP route

```
Qtech(config)# router ospf 1
```

```
Qtech(config router)# network 10.1.0.0 0.0.255.255 area 0
```

```
Qtech(config router)# exit
```

```
Qtech(config)# router ospf 2
```

```
Qtech(config router)# network 1.1.1.1 0.0.0.0 area 0
```

```
Qtech(config router)# network 5.5.5.0 0.0.0.255 area 0
```

```
Qtech(config router)# exit
```

Configure MPLS network

```
Qtech(config)# mpls ip
```

```
Qtech(config)# mpls router ldp
```

```
Qtech(config mpls router)# ldp router id interface loopback 0 force
```

```
Qtech(config mpls router)# exit
```

```
Qtech(config)# interface tunnel 0
```

In case of a router, enable fast forwarding on the interface (not applicable to a switch)

```
Qtech(config if)# ip ref
```

```
Qtech(config if)# mpls ip
```

```
Qtech(config if)# label switching
```

```
Qtech(config if)# exit
```

Configure MPLS VPN

Configure VRF

```
Qtech(config)# ip vrf vpn1
```

```
Qtech(config vrf)# rd 100:1
```

```
Qtech(config vrf)# route target both 100:1
```

```
Qtech(config vrf)# exit
```

```
Qtech(config)# interface gigabitEthernet 0/1
```

In case of a switch, configure the interface to RoutedPort interface (not applicable to a router)

```
Qtech(config if)# no switchport
```

In case of a router, enable fast forwarding on the interface (not applicable to a switch)

```
Qtech(config if)# ip ref
```

```
Qtech(config if)# ip vrf forwarding vpn1
```

```
Qtech(config if)# ip address 192.168.1.1 255.255.255.0
```

```
Qtech(config if)# no shutdown
```

```
Qtech(config if)# exit
```

Configure MP-IBGP

```
Qtech(config)# router bgp 100
```

```
Qtech(config router)# neighbor 2.2.2.2 remote as 100
```

```
Qtech(config router)# neighbor 2.2.2.2 update source Loopback 0
```

```
Qtech(config router)# address family vpnv4
```

```
Qtech(config router af)# neighbor 2.2.2.2 active
```

```
Qtech(config router af)# neighbor 2.2.2.2 send community both
```

```
Qtech(config router af)# exit
```

```
Qtech(config router)# address family ipv4 vrf vpn1
```

```
Qtech(config router af)# redistribute ospf 10 vrf vpn1
```

```
Qtech(config router af)# exit
```

```
Qtech(config router)# exit
```

Configure route exchanging between PE and CE

```
Qtech(config)# router ospf 10 vrf vpn1
```

```
Qtech(config router)# network 192.168.1.0 0.0.0.255 area 0
```

```
Qtech(config router)# redistribute bgp 100 subnets
```

```
Qtech(config router)# exit
```

❖ **Configure CE. Here we will take CE1 as the example. The configurations of CE2 are the same.**

```
Qtech(config)# interface gigabitEthernet 0/0
```

In case of a router, enable fast forwarding on the interface (not applicable to a switch)

```
Qtech(config if)# ip ref
```

```
Qtech(config if)# ip address 192.168.1.2 255.255.255.0
```

```
Qtech(config if)# no shutdown
```

```
Qtech(config if)# exit
```

```
Qtech(config)# router ospf 1
```

```
Qtech(config router)# network 192.168.1.0 0.0.0.255 area 0
```

```
Qtech(config router)# exit
```

Verification

On PE, check routing table entries. Here we will take PE1 as the example. The next-hop interface of route 2.2.2.2/32 is Tunnel 0.

```
Qtech# show ip route
Codes: C    connected, S    static, R    RIP, B    BGP
       O    OSPF, IA    OSPF inter area
       N1   OSPF NSSA external type 1, N2   OSPF NSSA external type 2
       E1   OSPF external type 1, E2   OSPF external type 2
       i    IS IS, su    IS IS summary, L1   IS IS level 1, L2   IS IS level 2
       ia   IS IS inter area, *    candidate default

Gateway of last resort is no set
C    10.1.0.0/16 is directly connected, gigabitEthernet 0/0
C    10.1.0.1/32 is local host.
C    1.0.0.0/8 is subnetted
C    1.1.1.1/32 is local host.
O    2.0.0.0/8 is subnetted
O    2.2.2.2/32 [110/11] via 5.5.5.2, 00:00:40, Tunnel 0
.....
```

Verify VPN route on PE. Here we will take PE1 as the example.

```
Qtech# show ip route vrf vpn1
Routing Table: vpn1

Codes: C    connected, S    static, R    RIP, B    BGP
       O    OSPF, IA    OSPF inter area
       N1   OSPF NSSA external type 1, N2   OSPF NSSA external type 2
       E1   OSPF external type 1, E2   OSPF external type 2
       i    IS IS, su    IS IS summary, L1   IS IS level 1, L2   IS IS level 2
       ia   IS IS inter area, *    candidate default

Gateway of last resort is no set
C    192.168.1.0/24 is directly connected, gigabitEthernet 0/1
C    192.168.1.1/32 is local host.
B    192.168.2.0/24 [200/0] via 2.2.2.2, 00:00:41
.....
```

Check MPLS forwarding table entries on PE. Here we will take PE1 as the example.

```
Qtech# show mpls forwarding table
Label Operation Code:
PH  PUSH label
PP  POP label
SW  SWAP label
SP  SWAP topmost label and push new label
DP  DROP packet
```

```

PC POP label and continue lookup( IP or Label )
PI POP label and do ip lookup forward
PN POP label and forward to nexthop
PM POP label and do MAC lookup forward
PV POP label and output to VC attach interface
IP IP lookup forward
Local Outgoing OP FEC Outgoing Next Hop
label label interface
3 PH 2.2.2.2/32 Tunnel 0 5.5.5.2
21 PH 192.168.2.0/24(V) Tunnel 0 Point2point
.....

```

Verify routing table on CE.

```

Qttech# show ip route
Codes: C connected, S static, R RIP, B BGP
O OSPF, IA OSPF inter area
N1 OSPF NSSA external type 1, N2 OSPF NSSA external type 2
E1 OSPF external type 1, E2 OSPF external type 2
i IS IS, su IS IS summary, L1 IS IS level 1, L2 IS IS level 2
ia IS IS inter area, * candidate default

Gateway of last resort is no set
C 192.168.1.0/24 is directly connected, gigabitEthernet 0/1
C 192.168.1.2/32 is local host.
O 192.168.2.0/24 [112/11] via 192.168.1.1, 00:00:41
.....

```

Verify the intercommunication between CEs. On CE1:

```

Qttech# ping 192.168.2.2
Sending 5, 100 byte ICMP Echoes to 192.168.2.2, timeout is 2 seconds:
< press Ctrl+C to break >
!!!!
Success rate is 100 percent (5/5), round trip min/avg/max = 10/20/40 ms

```

3.4.14 OSPF VPN configuration example

3.4.14.1 Domain-id configuration example

Networking Requirements

Two different sites of the client exchange VPN routes via MPLS backbone network. Client sites are connected with PE via OSPF protocol. It is required that the client's OSPF routes can be restored to the OSPF routes of original site after being exchanged over MPLS backbone network.

Topology

Figure 38

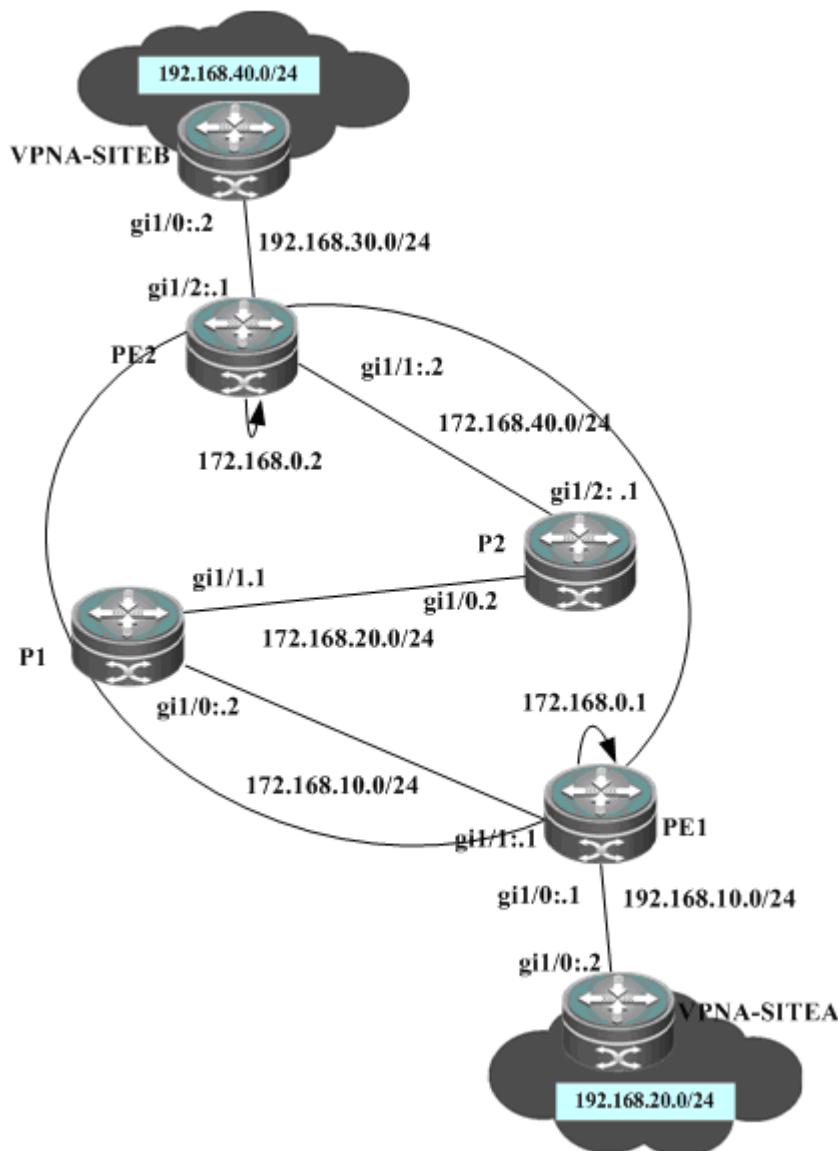

To meet such need, configure two VRF OSPF instances with same domain ID on two PEs, as shown below:

Configuration Steps

SITEA:

Configure OSPF protocol between PE and CE

```
Qtech# configure terminal
Qtech(config)# router ospf 10
Qtech(config router)# network 192.168.10.0 255.255.255.0 area 0
```

PE1:

Configure Loopback interface

```
Qtech# configure terminal
Qtech(config)# interface loopback 0
Qtech(config if Loopback 0)# ip address 172.168.0.1 255.255.255.255
```

Configure VRF

Create a VRF of "VPNA", define RD value and RT value, and associate VRF with the corresponding interface.

```
Qtech# configure terminal
Qtech(config)# ip vrf VPNA
Qtech(config vrf)# rd 1:100
Qtech(config vrf)# route target both 1:100
Qtech(config vrf)# end
```

Associate the CE-connecting interface with VRF

```
Qtech# configure terminal
Qtech(config)# interface gigabitethernet 1/0
```

In case of a switch, configure the interface to RoutedPort interface (not applicable to a router)

```
Qtech(config if GigabitEthernet 1/0)# no switchport
```

In case of a router, enable fast forwarding on the interface (not applicable to a switch)

```
Qtech(config if GigabitEthernet 1/0)# ip ref
Qtech(config if GigabitEthernet 1/0)# ip vrf forwarding VPNA
Qtech(config if GigabitEthernet 1/0)# ip address 192.168.10.1 255.255.255.0
Qtech(config if GigabitEthernet 1/0)# end
```

Configure BGP protocol to establish MP-IBGP session with PE2

```
Qtech# configure terminal
Qtech(config)# router bgp 1
Qtech(config router)# neighbor 172.168.0.2 remote as 1
Qtech(config router)# neighbor 172.168.0.2 update source loopback 0
```

```
Qtech(config router)# address family vpv4
Qtech(config router af)# neighbor 172.168.0.2 activate
Qtech(config router af)# end
```

Exchange routes with CE via OSPF protocol; configure the domain ID of OSPF instance to 10

```
Qtech# configure terminal
Qtech(config)# router ospf 10 VPNA
Qtech(config router)# network 192.168.10.0 255.255.255.0 area 0
Qtech(config router)# redistribute bgp subnets
Qtech(config router)# domain id 10
Qtech(config router)# exit
Qtech(config)# router bgp 1
Qtech(config router)# address family ipv4 vrf VPNA
Qtech(config router af)# redistribute ospf 10
Qtech(config router af)# end
```

Configure MPLS signaling protocol for backbone network. Enable MPLS capability on WAN interface.

```
Qtech# configure terminal
Qtech(config)# mpls ip
Qtech(config)# mpls router ldp
Qtech(config mpls router)# ldp router id interface loopback 0 force
Qtech(config mpls router)# exit
Qtech(config)# interface gigabitethernet 1/1
```

In case of a switch, configure the interface to RoutedPort interface (not applicable to a router)

```
Qtech(config if GigabitEthernet 1/1)# no switchport
```

In case of a router, enable fast forwarding on the interface (not applicable to a switch)

```
Qtech(config if GigabitEthernet 1/1)# ip ref
Qtech(config if GigabitEthernet 1/1)# ip address 172.168.10.1 255.255.255.0
Qtech(config if GigabitEthernet 1/1)# label switching
Qtech(config if GigabitEthernet 1/1)# mpls ip
Qtech(config if GigabitEthernet 1/1)# end
```

Configure routing protocol for the backbone network

```
Qtech# configure terminal
Qtech(config)# router ospf 1
Qtech(config router)# network 172.168.10.0 0.0.0.255 area 0
Qtech(config router)# network 172.168.0.1 0.0.0.0 area 0
Qtech(config router)# end
```

P1:P2:The configuration steps are similar to that of P in the MPLS backbone network

SITEB:

Configure to run OSPF with PE2

```
Qtech# configure terminal
Qtech(config)# router ospf 10
Qtech(config router)# network 192.168.30.0 255.255.255.0 area 0
```

PE2:

Configure Loopback interface

```
Qtech# configure terminal
Qtech(config)# interface loopback 0
Qtech(config if Loopback 0)# ip address 172.168.0.2 255.255.255.255
```

Configure VRF

Create a VRF of "VPNA", define RD value and RT value, and associate VRF with the corresponding interface.

```
Qtech# configure terminal
Qtech(config)# ip vrf VPNA
Qtech(config vrf)# rd 1:100
Qtech(config vrf)# route target both 1:100
Qtech(config vrf)# exit
```

Associate the CE-connecting interface with VRF

```
Qtech# configure terminal
Qtech(config)# interface gigabitethernet 1/2
```

In case of a switch, configure the interface to RoutedPort interface (not applicable to a router)

```
Qtech(config if GigabitEthernet 1/2)# no switchport
```

In case of a router, enable fast forwarding on the interface (not applicable to a switch)

```
Qtech(config if GigabitEthernet 1/2)# ip ref
Qtech(config if GigabitEthernet 1/2)# ip vrf forwarding VPNA
Qtech(config if GigabitEthernet 1/2)# ip address 192.168.30.1
255.255.255.0
Qtech(config if GigabitEthernet 1/0)# exit
```

Configure BGP protocol to establish MP-IBGP session with PE2

```
Qtech# configure terminal
Qtech(config)# router bgp 1
Qtech(config router)# neighbor 172.168.0.1 remote as 1
Qtech(config router)# neighbor 172.168.0.1 update source loopback 0
Qtech(config router)# address family vpnv4
Qtech(config router af)# neighbor 172.168.0.1 activate
Qtech(config router af)# end
```

Exchange VPN routes with CE via OSPF protocol; configure the domain ID to 10

```
Qtech# configure terminal
Qtech(config)# router ospf 10 VPNA
Qtech(config router)# network 192.168.30.0 255.255.255.0 area 0
Qtech(config router)# redistribute bgp subnets
Qtech(config router)# domain id 10
Qtech(config router)# exit
Qtech(config)# router bgp 1
Qtech(config router)# address family ipv4 vrf VPNA
Qtech(config router af)# redistribute ospf 10
Qtech(config router af)# exit
```

Configure MPLS signaling protocol for backbone network. Enable MPLS capability on WAN interface.

```
Qtech# configure terminal
Qtech(config)# mpls ip
Qtech(config)# mpls router ldp
Qtech(config mpls router)# ldp router id interface loopback 0 force
Qtech(config mpls router)# exit
Qtech(config)# interface gigabitethernet 1/1
```

In case of a switch, configure the interface to RoutedPort interface (not applicable to a router)

```
Qtech(config if GigabitEthernet 1/1)# no switchport
```

In case of a router, enable fast forwarding on the interface (not applicable to a switch)

```
Qtech(config if GigabitEthernet 1/1)# ip ref
Qtech(config if GigabitEthernet 1/1)# ip address 172.168.40.2 255.255.255.0
Qtech(config if GigabitEthernet 1/1)# label switching
Qtech(config if GigabitEthernet 1/1)# mpls ip
Qtech(config if GigabitEthernet 1/1)# end
```

Configure routing protocol for the backbone network

```
Qtech# configure terminal
Qtech(config)# router ospf 1
Qtech(config router)# network 172.168.40.0 0.0.0.255 area 0
Qtech(config router)# network 172.168.0.2 0.0.0.0 area 0
Qtech(config router)# end
```

Verify configurations

❖ VPNA-SITEB:

```
Qtech# show ip route
Codes: C    connected, S    static, R    RIP, B    BGP
        O    OSPF, IA    OSPF inter area
        N1   OSPF NSSA external type 1, N2   OSPF NSSA external type 2
        E1   OSPF external type 1, E2    OSPF external type 2
        i    IS IS, su    IS IS summary, L1   IS IS level 1, L2   IS IS level 2
```

```
ia IS IS inter area, * candidate default
```

Gateway of last resort is no set

```
O IA 192.168.10.0/24 [110/2] via 192.168.30.1, 00:00:36, GigabitEthernet 1/0
O IA 192.168.20.0/24 [110/2] via 192.168.30.1, 00:00:36, GigabitEthernet 1/0
C 192.168.30.0/24 is directly connected, GigabitEthernet 1/0
O 192.168.40.0/24 [110/101] via 192.168.24.2, 00:56:23, GigabitEthernet 1/1
```

❖ PE2:

```
Qttech# show ip route vrf VPNA
```

Routing Table: VPNA

Codes: C connected, S static, R RIP, B BGP

O OSPF, IA OSPF inter area

N1 OSPF NSSA external type 1, N2 OSPF NSSA external type 2

E1 OSPF external type 1, E2 OSPF external type 2

i IS IS, su IS IS summary, L1 IS IS level 1, L2 IS IS level 2

ia IS IS inter area, * candidate default

Gateway of last resort is no set

```
B 192.168.10.0/24 [110/2] via 172.168.0.1, 00:00:36
B 192.168.20.0/24 [110/2] via 172.168.0.1, 00:00:36
C 192.168.30.0/24 is directly connected, GigabitEthernet 1/2
O 192.168.40.0/24 [110/101] via 192.168.30.2, 00:56:23, GigabitEthernet 1/2
```

❖ PE1:

```
Qttech# show ip route vrf VPNA
```

Routing Table: VPNA

Codes: C connected, S static, R RIP, B BGP

O OSPF, IA OSPF inter area

N1 OSPF NSSA external type 1, N2 OSPF NSSA external type 2

E1 OSPF external type 1, E2 OSPF external type 2

i IS IS, su IS IS summary, L1 IS IS level 1, L2 IS IS level 2

ia IS IS inter area, * candidate default

Gateway of last resort is no set

```
C 192.168.10.0/24 is directly connected, GigabitEthernet 1/0
O 192.168.20.0/24 [110/101] via 192.168.10.2, 00:56:23, GigabitEthernet 1/0
B 192.168.30.0/24 [110/2] via 172.168.0.2, 00:00:36
B 192.168.40.0/24 [110/2] via 172.168.0.2, 00:00:36
```

❖ VPNA-SITEA:

```
Qttech# show ip route
Codes: C    connected, S    static, R    RIP, B    BGP
        O    OSPF, IA    OSPF inter area
        N1   OSPF NSSA external type 1, N2   OSPF NSSA external type 2
        E1   OSPF external type 1, E2   OSPF external type 2
        i    IS IS, su    IS IS summary, L1   IS IS level 1, L2   IS IS level 2
        ia   IS IS inter area, *    candidate default

Gateway of last resort is no set

C    192.168.10.0/24 is directly connected, GigabitEthernet 1/0
O    192.168.20.0/24 [110/101] via 192.168.23.2, 00:56:23, GigabitEthernet 1/1
O IA  192.168.30.0/24 [110/2] via 192.168.10.1, 00:00:36, GigabitEthernet 1/0
O IA  192.168.40.0/24 [110/2] via 192.168.10.1, 00:00:36, GigabitEthernet 1/0
```

3.4.14.2 Sham-link configuration example

Networking Requirements

Two different sites of the client exchange VPN routes via MPLS backbone network. At the same time, a "backdoor link" is also established between these two sites to ensure that information can still be exchanged between both sites through this backup link when the MPLS backbone network fails.

Topology

Figure 39

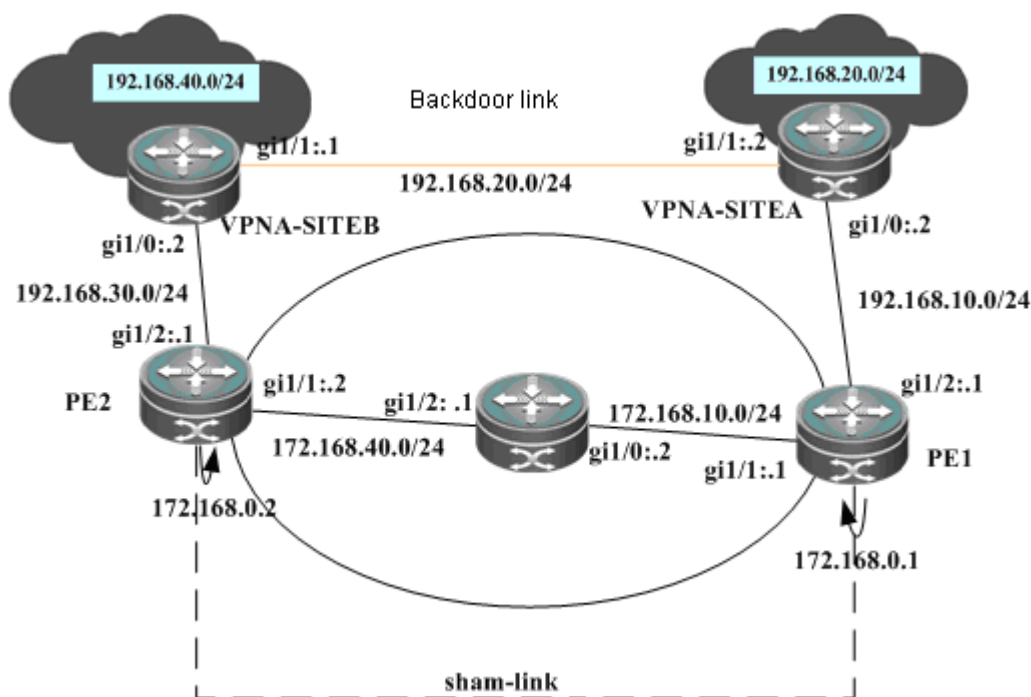

Configuration Steps

SITEA:

Configure to run OSPF protocol with PE1 and SITEB. The OSPF protocol runs over the backdoor link with SITEB.

```
Qtech# configure terminal
Qtech(config)# router ospf 10
Qtech(config router)# network 192.168.10.0 255.255.255.0 area 0
Qtech(config router)# network 192.168.20.0 255.255.255.0 area 0
```

Configure OSPF cost on interface

```
Qtech# configure terminal
Qtech(config)# interface gigabitethernet 1/0
```

In case of a switch, configure the interface to RoutedPort interface (not applicable to a router)

```
Qtech(config if GigabitEthernet 1/0)# no switchport
```

In case of a router, enable fast forwarding on the interface (not applicable to a switch)

```
Qtech(config if GigabitEthernet 1/0)# ip ref
Qtech(config if GigabitEthernet 1/0)# ip address 192.168.10.2 255.255.255.0
Qtech(config if GigabitEthernet 1/0)# ip ospf cost 1
```

```
Qtech(config)# interface gigabitethernet 1/1
```

In case of a switch, configure the interface to RoutedPort interface (not applicable to a router)

```
Qtech(config if GigabitEthernet 1/1)# no switchport
```

In case of a router, enable fast forwarding on the interface (not applicable to a switch)

```
Qtech(config if GigabitEthernet 1/1)# ip ref
```

```
Qtech(config if GigabitEthernet 1/1)# ip address 192.168.20.1 255.255.255.0
```

```
Qtech(config if GigabitEthernet 1/1)# ip ospf cost 200
```

PE1:

Configure Loopback interface

```
Qtech# configure terminal
```

```
Qtech(config)# interface loopback 0
```

```
Qtech(config if Loopback 0)# ip address 172.168.0.1 255.255.255.255
```

Configure VRF

Create a VRF of " VPNA", define RD value and RT value, and associate VRF with the corresponding interface.

```
Qtech# configure terminal
```

```
Qtech(config)# ip vrf VPNA
```

```
Qtech(config vrf)# rd 1:100
```

```
Qtech(config vrf)# route target both 1:100
```

```
Qtech(config vrf)# end
```

Associate the CE-connecting interface with VRF

```
Qtech# configure terminal
```

```
Qtech(config)# interface gigabitethernet 1/2
```

In case of a switch, configure the interface to RoutedPort interface (not applicable to a router)

```
Qtech(config if GigabitEthernet 1/2)# no switchport
```

In case of a router, enable fast forwarding on the interface (not applicable to a switch)

```
Qtech(config if GigabitEthernet 1/2)# ip ref
```

```
Qtech(config if GigabitEthernet 1/2)# ip vrf forwarding VPNA
```

```
Qtech(config if GigabitEthernet 1/2)# ip address 192.168.10.1 255.255.255.0
```

```
Qtech(config if GigabitEthernet 1/2)# end
```

Configure VRF Loopback interface to establish sham-link

```
Qtech# configure terminal
```

```
Qtech(config)# interface loopback 10
```

```
Qtech(config if Loopback 10)# ip vrf forwarding VPNA
```

```
Qtech(config if Loopback 10)# ip address 192.168.0.1 255.255.255.255
```

Configure BGP protocol to establish MP-IBGP session with PE2

```
Qtech# configure terminal
Qtech(config)# router bgp 1
Qtech(config router)# neighbor 172.168.0.2 remote as 1
Qtech(config router)# neighbor 172.168.0.2 update source loopback 0
Qtech(config router)# address family vpnv4
Qtech(config router af)# neighbor 172.168.0.2 activate
Qtech(config router af)# end
```

Exchange routes with CE via OSPF protocol, and establish sham-link with the OSPF instance on PE2

```
Qtech# configure terminal
Qtech(config)# router ospf 10 VPNA
Qtech(config router)# network 192.168.10.0 255.255.255.0 area 0
Qtech(config router)# redistribute bgp subnets
Qtech(config router)# area 0 sham link 192.168.0.1 192.168.0.2
Qtech(config router)# exit
Qtech(config)# router bgp 1
Qtech(config router)# address family ipv4 vrf VPNA
Qtech(config router af)# redistribute ospf 10
Qtech(config router af)# redistribute connected
Qtech(config router af)# end
```

Configure MPLS signaling protocol for backbone network. Enable MPLS capability on WAN interface.

```
Qtech# configure terminal
Qtech(config)# mpls ip
Qtech(config)# mpls router ldp
Qtech(config mpls router)# ldp router id interface loopback 0 force
Qtech(config mpls router)# exit
Qtech(config)# interface gigabitethernet 1/1
```

In case of a switch, configure the interface to RoutedPort interface (not applicable to a router)

```
Qtech(config if GigabitEthernet 1/1)# no switchport
```

In case of a router, enable fast forwarding on the interface (not applicable to a switch)

```
Qtech(config if GigabitEthernet 1/1)# ip ref
Qtech(config if GigabitEthernet 1/1)# ip address 172.168.10.1 255.255.255.0
Qtech(config if GigabitEthernet 1/1)# label switching
Qtech(config if GigabitEthernet 1/1)# mpls ip
Qtech(config if GigabitEthernet 1/1)# end
```

Configure routing protocol for the backbone network

```
Qtech# configure terminal
Qtech(config)# router ospf 1
```

```
Qtech(config router)# network 172.168.10.0 0.0.0.255 area 0
Qtech(config router)# network 172.168.0.1 0.0.0.0 area 0
Qtech(config router)# end
```

P1:

The configuration steps are similar to that of P in the MPLS backbone network

SITEB:

Configure to run OSPF protocol with PE2 and SITEA. The OSPF protocol runs over the backup link with SITEA.

```
Qtech# configure terminal
Qtech(config)# router ospf 10
Qtech(config router)# network 192.168.30.0 255.255.255.0 area 0
Qtech(config router)# network 192.168.20.0 255.255.255.0 area 0
```

Configure OSPF cost on interface

```
Qtech# configure terminal
Qtech(config)# interface gigabitethernet 1/0
```

In case of a switch, configure the interface to RoutedPort interface (not applicable to a router)

```
Qtech(config if GigabitEthernet 1/0)# no switchport
```

In case of a router, enable fast forwarding on the interface (not applicable to a switch)

```
Qtech(config if GigabitEthernet 1/0)# ip ref
Qtech(config if GigabitEthernet 1/0)# ip address 192.168.30.2 255.255.255.0
Qtech(config if GigabitEthernet 1/0)# ip ospf cost 1
Qtech(config)# interface gigabitethernet 1/1
```

In case of a switch, configure the interface to RoutedPort interface (not applicable to a router)

```
Qtech(config if GigabitEthernet 1/1)# no switchport
```

In case of a router, enable fast forwarding on the interface (not applicable to a switch)

```
Qtech(config if GigabitEthernet 1/1)# ip ref
Qtech(config if GigabitEthernet 1/1)# ip address 192.168.20.2 255.255.255.0
Qtech(config if GigabitEthernet 1/1)# ip ospf cost 200
```

PE2:

Configure Loopback interface

```
Qtech# configure terminal
Qtech(config)# interface loopback 0
Qtech(config if Loopback 0)# ip address 172.168.0.2 255.255.255.255
```

Configure VRF

Create a VRF of "VPNA", define RD value and RT value, and associate VRF with the corresponding interface.

```
Qtech# configure terminal
Qtech(config)# ip vrf VPNA
Qtech(config vrf)# rd 1:100
Qtech(config vrf)# route target both 1:100
Qtech(config vrf)# exit
```

Associate the CE-connecting interface with VRF

```
Qtech# configure terminal
Qtech(config)# interface gigabitethernet 1/2
```

In case of a switch, configure the interface to RoutedPort interface (not applicable to a router)

```
Qtech(config if GigabitEthernet 1/2)# no switchport
```

In case of a router, enable fast forwarding on the interface (not applicable to a switch)

```
Qtech(config if GigabitEthernet 1/2)# ip ref
Qtech(config if GigabitEthernet 1/2)# ip vrf forwarding VPNA
Qtech(config if GigabitEthernet 1/2)# ip address 192.168.30.1
255.255.255.0
Qtech(config if GigabitEthernet 1/2)# exit
```

Configure VRF Loopback interface to establish sham-link

```
Qtech# configure terminal
Qtech(config)# interface loopback 10
Qtech(config if Loopback 10)# ip vrf forwarding VPNA
Qtech(config if Loopback 10)# ip address 192.168.0.2 255.255.255.255
```

Configure BGP protocol to establish MP-IBGP session with PE2 and PE3

```
Qtech# configure terminal
Qtech(config)# router bgp 1
Qtech(config router)# neighbor 172.168.0.1 remote as 1
Qtech(config router)# neighbor 172.168.0.1 update source loopback 0
Qtech(config router)# address family vpnv4
Qtech(config router af)# neighbor 172.168.0.1 activate
Qtech(config router af)# end
```

Exchange VPN routes with CE via OSPF protocol, and establish sham-link with PE1

```
Qtech# configure terminal
Qtech(config)# router ospf 10 VPNA
Qtech(config router)# network 192.168.30.0 255.255.255.0 area 0
Qtech(config router)# redistribute bgp subnets
Qtech(config router)# area 0 sham link 192.168.0.2 192.168.0.1
Qtech(config router)# exit
Qtech(config)# router bgp 1
```

```
Qtech(config router)# address family ipv4 vrf VPNA
Qtech(config router af)# redistribute ospf 10
uiejie(config router af)# redistribute connected
Qtech(config router af)# exit
```

Configure MPLS signaling protocol for backbone network. Enable MPLS capability on WAN interface.

```
Qtech# configure terminal
Qtech(config)# mpls ip
Qtech(config)# mpls router ldp
Qtech(config mpls router)# ldp router id interface loopback 0 force
Qtech(config mpls router)# exit
Qtech(config)# interface gigabitethernet 1/1
```

In case of a switch, configure the interface to RoutedPort interface (not applicable to a router)

```
Qtech(config if GigabitEthernet 1/1)# no switchport
```

In case of a router, enable fast forwarding on the interface (not applicable to a switch)

```
Qtech(config if GigabitEthernet 1/1)# ip ref
Qtech(config if GigabitEthernet 1/1)# ip address 172.168.40.2 255.255.255.0
Qtech(config if GigabitEthernet 1/1)# label switching
Qtech(config if GigabitEthernet 1/1)# mpls ip
Qtech(config if GigabitEthernet 1/1)# end
```

Configure routing protocol for the backbone network

```
Qtech# configure terminal
Qtech(config)# router ospf 1
Qtech(config router)# network 172.168.40.0 0.0.0.255 area 0
Qtech(config router)# network 172.168.0.2 0.0.0.0 area 0
Qtech(config router)# end
```

Verify configurations

❖ PE1

```
Qtech# show ip ospf 10 sham links
Sham Link OSPF_SL0 to address 192.168.0.2 is up
Area 0 source address 192.168.0.1
Run as demand circuit
DoNotAge LSA allowed. Cost of using 1 State POINT_TO_POINT,
Timer intervals configured, Hello 10, Dead 40, Wait 40,
Hello due in 00:00:06
Adjacency State FULL (Hello suppressed)
Index 2/2, retransmission queue length 0, number of retransmission 0
First 0x0(0)/0x0(0) Next 0x0(0)/0x0(0)
Last retransmission scan length is 0, maximum is 0
Last retransmission scan time is 0 msec, maximum is 0 msec
```

```

Qttech# show ip ospf 10 neighbor
Neighbor ID      Pri   State           Dead Time   Address      Interface
192.168.0.2      0    FULL/           192.168.0.2 OSPF_SL0
Qttech# show ip route vrf VPNA
Codes: C    connected, S    static, R    RIP, B    BGP
O    OSPF, IA    OSPF inter area
N1   OSPF NSSA external type 1, N2   OSPF NSSA external type 2
E1   OSPF external type 1, E2   OSPF external type 2
i    IS IS, su   IS IS summary, L1   IS IS level 1, L2   IS IS level 2
ia   IS IS inter area, *    candidate default
C    192.168.10.0/24 is directly connected, Gi1/2
O    192.168.20.0/24 [110/101] via 192.168.1.2, 00:56:23, Gi1/2
O    192.168.40.0/24 [110/2] via 172.168.0.2, 00:00:36

```

❖ PE2

```

Qttech# show ip ospf 10 sham links
Sham Link SLINK0 to address 192.168.0.1 is up
Area 0.0.0.0 source address 192.168.0.2, Cost: 1
Output interface is GigabitEthernet 1/1
Nextthop address 172.16.10.1
Transmit Delay is 1 sec, State Point To Point,
Timer intervals configured, Hello 10, Dead 40, Wait 40, Retransmit 5
Hello due in 00:00:01
Adjacency state Full

Qttech# show ip ospf 10 neighbor

OSPF process 10, 1 Neighbors, 1 is Full:
Neighbor ID      Pri   State           BFD State   Dead Time   Address      Interface
192.168.0.1      1    Full/           00:00:34    192.168.0.1 SLINK0

Qttech# show ip route vrf VPNA
Routing Table: VPNA

Codes: C    connected, S    static, R    RIP, B    BGP
O    OSPF, IA    OSPF inter area
N1   OSPF NSSA external type 1, N2   OSPF NSSA external type 2
E1   OSPF external type 1, E2   OSPF external type 2
i    IS IS, su   IS IS summary, L1   IS IS level 1, L2   IS IS level 2
ia   IS IS inter area, *    candidate default

Gateway of last resort is no set
O    192.168.10.0/24 [110/2] via 172.168.0.1, 00:00:36

```

```

O 192.168.20.0/24 [110/2] via 172.168.0.1, 00:00:36
C 192.168.30.0/24 is directly connected, GigabitEthernet 1/2
O 192.168.40.0/24 [110/101] via 192.168.30.2, 00:56:23, GigabitEthernet 1/2

```

3.4.14.3 Configure multiple OSPF instances on MCE

Networking Requirements

The client site involves multiple services, with same service communicating with each other over MPLS backbone network and different services isolated from each other.

Topology

Figure 40

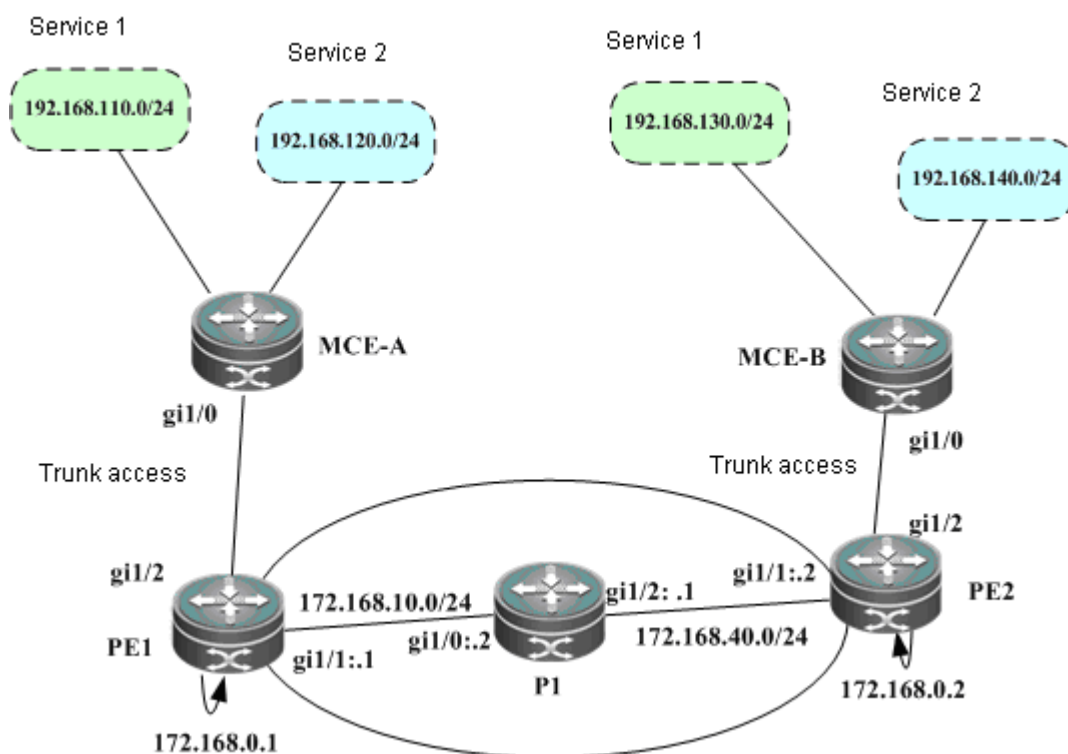

Configuration Steps

MCE-A:

Configure Trunk link between PE and CE

```

Qtech# configure terminal
Qtech(config)# interface gigabitethernet 1/0

```

VLAN is the configuration command used on switch products, and is not applicable to routers (except for the switching card interface). Routers can use the routing interface to connect with PE.

```

Qtech(config if GigabitEthernet 1/0)# switchport mode trunk

```

```
Qtech(config if GigabitEthernet 1/0)# end
```

Configure two VRFs to represent different services and bind respective interfaces

```
Qtech# configure terminal
Qtech(config)# ip vrf VPN1
Qtech(config vrf)# exit
Qtech(config)# VLAN 10
Qtech(config)# interface vln 10
```

VLAN is the configuration command used on switch products, and is not applicable to routers (except for the switching card interface). Routers can use the subinterface to bind VRF.

```
Qtech(config if vln 10)# ip vrf forwarding VPN1
Qtech(config if vln 10)# ip address 192.168.10.2 255.255.255.0
Qtech(config)# ip vrf VPN2
Qtech(config vrf)# exit
Qtech(config)# VLAN 20
Qtech(config)# interface vln 20
```

VLAN is the configuration command used on switch products, and is not applicable to routers (except for the switching card interface). Routers can use the sub-interface to bind VRF.

```
Qtech(config if vln 20)# ip vrf forwarding VPN2
Qtech(config if vln 20)# ip address 192.168.20.2 255.255.255.0
```

Configure to run OSPF protocol with PE for two VRFs

```
Qtech# configure terminal
Qtech(config)# router ospf 10 VPN1
Qtech(config router)# network 192.168.10.0 255.255.255.0 area 0
Qtech(config router)# capability vrf lite

Qtech(config)# router ospf 10 VPN2
Qtech(config router)# network 192.168.20.0 255.255.255.0 area 0
Qtech(config router)# capability vrf lite
```

PE1:

Configure Loopback interface

```
Qtech# configure terminal
Qtech(config)# interface loopback 0
Qtech(config if Loopback 0)# ip address 172.168.0.1 255.255.255.255
```

Configure Trunk link between PE and CE

```
Qtech(config)# interface gigabitethernet 1/2
Qtech(config if GigabitEthernet 1/2)# switchport mode trunk
Qtech(config if GigabitEthernet 1/2)# end
```

Configure VRF

Create two VRFs of "VPN1" and "VPN2" to represent different services, and associate VRF with the corresponding interface.

```
Qtech# configure terminal
Qtech(config)# ip vrf VPN1
Qtech(config vrf)# rd 1:100
Qtech(config vrf)# route target both 1:100
Qtech(config vrf)# end
Qtech# configure terminal
Qtech(config)# ip vrf VPN2
Qtech(config vrf)# rd 1:200
Qtech(config vrf)# route target both 1:200
Qtech(config vrf)# end
```

Associate the CE-connecting interface with VRF

```
Qtech(config)# VLAN 10
Qtech(config)# interface vlan 10
```

VLAN is the configuration command used on switch products, and is not applicable to routers (except for the switching card interface). Routers can use the subinterface to bind VRF.

```
Qtech(config if vlan 10)# ip vrf forwarding VPN1
Qtech(config if vlan 10)# ip address 192.168.10.1 255.255.255.0
```

```
Qtech(config)# VLAN 20
Qtech(config)# interface vlan 20
```

VLAN is the configuration command used on switch products, and is not applicable to routers (except for the switching card interface). Routers can use the sub-interface to bind VRF.

```
Qtech(config if vlan 20)# ip vrf forwarding VPN1
Qtech(config if vlan 20)# ip address 192.168.20.1 255.255.255.0
```

Configure BGP protocol to establish MP-IBGP session with PE2

```
Qtech# configure terminal
Qtech(config)# router bgp 1
Qtech(config router)# neighbor 172.168.0.2 remote as 1
Qtech(config router)# neighbor 172.168.0.2 update source loopback 0
Qtech(config router)# address family vpnv4
Qtech(config router af)# neighbor 172.168.0.2 activate
Qtech(config router af)# end
```

Exchange routes with CE via OSPF protocol

```
Qtech# configure terminal
Qtech(config)# router ospf 10 VPN1
Qtech(config router)# network 192.168.10.0 255.255.255.0 area 0
Qtech(config router)# exit
```



```
Qtech(config)# router bgp 1
Qtech(config router)# address family ipv4 vrf VPNA
Qtech(config router af)# redistribute ospf 10
Qtech(config router af)# redistribute connected
Qtech(config router af)# end

Qtech# configure terminal
Qtech(config)# router ospf 20 VPN2
Qtech(config router)# network 192.168.20.0 255.255.255.0 area 0
Qtech(config router)# redistribute bgp subnets
Qtech(config router)# exit
Qtech(config)# router bgp 1
Qtech(config router)# address family ipv4 vrf VPN2
Qtech(config router af)# redistribute ospf 20
Qtech(config router af)# redistribute connected
Qtech(config router af)# end
```

Configure MPLS signaling protocol for backbone network. Enable MPLS capability on WAN interface.

```
Qtech# configure terminal
Qtech(config)# mpls ip
Qtech(config)# mpls router ldp
Qtech(config mpls router)# ldp router id interface loopback 0 force
Qtech(config mpls router)# exit
Qtech(config)# interface gigabitethernet 1/1
```

In case of a switch, configure the interface to RoutedPort interface (not applicable to a router)

```
Qtech(config if GigabitEthernet 1/1)# no switchport
```

In case of a router, enable fast forwarding on the interface (not applicable to a switch)

```
Qtech(config if GigabitEthernet 1/1)# ip ref
Qtech(config if GigabitEthernet 1/1)# ip address 172.168.10.1 255.255.255.0
Qtech(config if GigabitEthernet 1/1)# label switching
Qtech(config if GigabitEthernet 1/1)# mpls ip
Qtech(config if GigabitEthernet 1/1)# end
```

Configure routing protocol for the backbone network

```
Qtech# configure terminal
Qtech(config)# router ospf 1
Qtech(config router)# network 172.168.10.0 0.0.0.255 area 0
Qtech(config router)# network 172.168.0.1 0.0.0.0 area 0
Qtech(config router)# end
```

P1:

The configuration steps are similar to that of P in the MPLS backbone network

SITEB:

Configure Trunk link between PE and CE

```
Qtech# configure terminal
Qtech(config)# interface gigabitethernet 1/0
```

VLAN is the configuration command used on switch products, and is not applicable to routers (except for the switching card interface). Routers can use the routing interface to connect with PE.

```
Qtech(config if GigabitEthernet 1/0)# switchport mode trunk
Qtech(config if GigabitEthernet 1/0)# end
```

Configure two VRFs to represent different services and bind respective interfaces

```
Qtech# configure terminal
Qtech(config)# ip vrf VPN1
Qtech(config vrf)# exit
Qtech(config)# VLAN 10
Qtech(config)# interface vln 30
```

VLAN is the configuration command used on switch products, and is not applicable to routers (except for the switching card interface). Routers can use the subinterface to bind VRF.

```
Qtech(config if vln 10)# ip vrf forwarding VPN1
Qtech(config if vln 10)# ip address 192.168.30.2 255.255.255.0
```

```
Qtech(config)# ip vrf VPN2
Qtech(config vrf)# exit
Qtech(config)# VLAN 40
Qtech(config)# interface vln 40
```

VLAN is the configuration command used on switch products, and is not applicable to routers (except for the switching card interface). Routers can use the sub-interface to bind VRF.

```
Qtech(config if vln 20)# ip vrf forwarding VPN2
Qtech(config if vln 20)# ip address 192.168.40.2 255.255.255.0
```

Configure to run OSPF protocol with PE for two VRFs

```
Qtech# configure terminal
Qtech(config)# router ospf 10 VPN1
Qtech(config router)# network 192.168.30.0 255.255.255.0 area 0
Qtech(config router)# capability vrf lite

Qtech(config)# router ospf 10 VPN2
Qtech(config router)# network 192.168.40.0 255.255.255.0 area 0
Qtech(config router)# capability vrf lite
```

PE2:

Configure Loopback interface

```
Qtech# configure terminal
Qtech(config)# interface loopback 0
Qtech(config if Loopback 0)# ip address 172.168.0.2 255.255.255.255
```

Configure Trunk link between PE and CE

```
Qtech(config)# interface gigabitethernet 1/2
Qtech(config if GigabitEthernet 1/2)# switchport mode trunk
Qtech(config if GigabitEthernet 1/2)# end
```

Configure VRF

Create two VRFs of "VPN1" and "VPN2" to represent different services, and associate VRF with the corresponding interface.

```
Qtech# configure terminal
Qtech(config)# ip vrf VPN1
Qtech(config vrf)# rd 1:100
Qtech(config vrf)# route target both 1:100
Qtech(config vrf)# end
Qtech# configure terminal
Qtech(config)# ip vrf VPN2
Qtech(config vrf)# rd 1:200
Qtech(config vrf)# route target both 1:200
Qtech(config vrf)# end
```

Associate the CE-connecting interface with VRF

```
Qtech(config)# VLAN 30
Qtech(config)# interface vlan 30
```

VLAN is the configuration command used on switch products, and is not applicable to routers (except for the switching card interface). Routers can use the subinterface to bind VRF.

```
Qtech(config if vlan 10)# ip vrf forwarding VPN1
Qtech(config if vlan 10)# ip address 192.168.30.1 255.255.255.0
```

```
Qtech(config)# VLAN 40
Qtech(config)# interface vlan 40
```

VLAN is the configuration command used on switch products, and is not applicable to routers. Routers can use the sub-interface to bind VRF.

```
Qtech(config if vlan 20)# ip vrf forwarding VPN2
Qtech(config if vlan 20)# ip address 192.168.40.1 255.255.255.0
```

Configure BGP protocol to establish MP-IBGP session with PE2

```
Qtech# configure terminal
Qtech(config)# router bgp 1
Qtech(config router)# neighbor 172.168.0.1 remote as 1
Qtech(config router)# neighbor 172.168.0.1 update source loopback 0
Qtech(config router)# address family vpnv4
Qtech(config router af)# neighbor 172.168.0.1 activate
Qtech(config router af)# end
```

Exchange routes with CE via OSPF protocol

```
Qtech# configure terminal
Qtech(config)# router ospf 10 VPN1
Qtech(config router)# network 192.168.30.0 255.255.255.0 area 0
Qtech(config router)# redistribute bgp subnets
Qtech(config router)# exit
Qtech(config)# router bgp 1
Qtech(config router)# address family ipv4 vrf VPN1
Qtech(config router af)# redistribute ospf 10
Qtech(config router af)# redistribute connected
Qtech(config router af)# end
```

```
Qtech# configure terminal
Qtech(config)# router ospf 20 VPN2
Qtech(config router)# network 192.168.40.0 255.255.255.0 area 0
Qtech(config router)# redistribute bgp subnets
Qtech(config router)# exit
Qtech(config)# router bgp 1
Qtech(config router)# address family ipv4 vrf VPN2
Qtech(config router af)# redistribute ospf 20
Qtech(config router af)# redistribute connected
Qtech(config router af)# end
```

Configure MPLS signaling protocol for backbone network. Enable MPLS capability on WAN interface.

```
Qtech# configure terminal
Qtech(config)# mpls ip
Qtech(config)# mpls router ldp
Qtech(config mpls router)# ldp router id interface loopback 0 force
Qtech(config mpls router)# exit
Qtech(config)# interface gigabitethernet 1/1
```

In case of a switch, configure the interface to RoutedPort interface (not applicable to a router)

```
Qtech(config if GigabitEthernet 1/1)# no switchport
```

In case of a router, enable fast forwarding on the interface (not applicable to a switch)

```
Qtech(config if GigabitEthernet 1/1)# ip ref
Qtech(config if GigabitEthernet 1/1)# ip address 172.168.40.2 255.255.255.0
Qtech(config if GigabitEthernet 1/1)# label switching
Qtech(config if GigabitEthernet 1/1)# mpls ip
Qtech(config if GigabitEthernet 1/1)# end
```

Configure routing protocol for the backbone network

```
Qtech# configure terminal
Qtech(config)# router ospf 1
Qtech(config router)# network 172.168.40.0 0.0.0.255 area 0
Qtech(config router)# network 172.168.0.2 0.0.0.0 area 0
Qtech(config router)# end
Verify configurations
MCEA
Qtech# show ip route vrf VPN1
Codes: C    connected, S    static, R    RIP, B    BGP
        O    OSPF, IA    OSPF inter area
        N1   OSPF NSSA external type 1, N2   OSPF NSSA external type 2
        E1   OSPF external type 1, E2   OSPF external type 2
        i   IS IS, su   IS IS summary, L1   IS IS level 1, L2   IS IS level 2
        ia   IS IS inter area, *   candidate default
C       192.168.10.0/24 is directly connected, VLAN 10
O       192.168.110.0/24 [110/101] via 192.168.21.2, 00:56:23, Gi1/1
O E2    192.168.130.0/24 [110/2] via 192.168.10.1, 00:00:36, VLAN 10

Qtech# show ip route vrf VPN2
Codes: C    connected, S    static, R    RIP, B    BGP
        O    OSPF, IA    OSPF inter area
        N1   OSPF NSSA external type 1, N2   OSPF NSSA external type 2
        E1   OSPF external type 1, E2   OSPF external type 2
        i   IS IS, su   IS IS summary, L1   IS IS level 1, L2   IS IS level 2
        ia   IS IS inter area, *   candidate default
C       192.168.20.0/24 is directly connected, VLAN 20
O       192.168.120.0/24 [110/101] via 192.168.22.2, 00:56:23, Gi1/2
O E2    192.168.140.0/24 [110/2] via 192.168.20.1, 00:00:36, VLAN 20
```

❖ MCEB

```
Qtech# show ip route vrf VPN1
Codes: C    connected, S    static, R    RIP, B    BGP
        O    OSPF, IA    OSPF inter area
        N1   OSPF NSSA external type 1, N2   OSPF NSSA external type 2
        E1   OSPF external type 1, E2   OSPF external type 2
        i   IS IS, su   IS IS summary, L1   IS IS level 1, L2   IS IS level 2
```

```
ia IS IS inter area, * candidate default
C 192.168.30.0/24 is directly connected, VLAN 30
O 192.168.130.0/24 [110/101] via 192.168.23.2, 00:56:23, Gi1/1
O E2 192.168.110.0/24 [110/2] via 192.168.30.1, 00:00:36, VLAN 30

Qttech# show ip route vrf VPN2
Codes: C connected, S static, R RIP, B BGP
O OSPF, IA OSPF inter area
N1 OSPF NSSA external type 1, N2 OSPF NSSA external type 2
E1 OSPF external type 1, E2 OSPF external type 2
i IS IS, su IS IS summary, L1 IS IS level 1, L2 IS IS level 2
ia IS IS inter area, * candidate default
C 192.168.40.0/24 is directly connected, VLAN 40
O 192.168.140.0/24 [110/101] via 192.168.24.2, 00:56:23, Gi1/2
O E2 192.168.140.0/24 [110/2] via 192.168.40.1, 00:00:36, VLAN 40
```

4. CONFIGURING MPLS GR

4.1 LDP GR

4.1.1 Overview

The Internet Engineering Task Force (IETF) has extended the Label Distribution Protocol (LDP), which is the signaling protocol of Multiprotocol Label Switching (MPLS), so that a device may instruct neighbors to keep related MPLS forwarding entries and set an "Old" flag for these MPLS forwarding entries when the LDP is restarted on the device. After the LDP is restarted, neighbors will assist the device to implement information synchronization so that the device is restored to the status before the LDP restart within the shortest possible time. The packet forwarding path does not change at all and data forwarding is not interrupted in the system throughout the LDP restart, thus guaranteeing the high reliability of MPLS application services.

4.1.1.1 Basic Concepts

GR Routers Classified by Capability

Graceful Restart (GR) routers are classified by capability into GR-capable routers, GR-aware routers, and GR-unaware routers.

❖ GR-Capable Router

A GR-capable router is a router that has GR capability. In general, a GR-capable router is equipped with two management boards which work in 1+1 master/slave mode. The GR-capable router can send an advertisement packet to neighboring routers during master/slave switchover of its management boards, so that neighboring routers keep forwarding entries related to the GR-capable router. After master/slave switchover of the management boards, routing tables are re-established without causing route flapping or changing the packet forwarding path, thus guaranteeing uninterrupted data forwarding in the system.

❖ GR-Aware Router

A GR-aware router is a router that has GR detection capability. Not necessarily equipped with two management boards, a GR-aware router is able to detect that its neighbors are experiencing GR and to assist its neighbors to complete GR.

❖ GR-Unaware Router

A GR-unaware router is a router that does not have GR detection capability. It cannot detect that its neighbors are experiencing GR, cannot assist its neighbors to complete GR, and does not have GR capability, generally because the system software does not provide the GR feature or the GR feature is disabled.

GR Routers Classified by Role

GR routers are classified by role during router restart into GR restarters and GR helpers.

❖ GR Restarter

The GR restarter has GR capability and its restart is triggered by administrators or faults.

❖ GR Helper

The GR helper is a neighbor of the GR restarter. It must be at least a GR-aware router.

4.1.1.2 Working Principles

The LDP GR function must be enabled on and supported by two routers in order to establish a GR-capable LDP session between them. If either router does not support GR during LDP session establishment, only a common LDP session can be established. If the initiator supports LDP GR and LDP GR is enabled on it during LDP session establishment, the initiator sends an Initialization message that carries an FT Session TLV.

If the passive router receives an Initialization message that carries an FT Session TLV during session establishment, it may choose to add or not add the FT Session TLV to the Initialization message to be sent to the initiator depending on its LDP GR capability. If the passive router supports LDP GR and LDP GR is enabled on it, the Initialization message will carry the FT Session TLV so as to establish a GR-capable LDP session; otherwise, the Initialization message will not carry the FT Session TLV so as to establish a common GR-incapable LDP session. If the passive router receives an Initialization message that does not carry the FT Session TLV, a common GR-incapable LDP session will be established, no matter whether the passive router adds the FT Session TLV to the Initialization message to be sent. Figure 1-1 shows the process of LDP session establishment between two Label Switching Routers (LSRs) with LDP GR capability.

Figure 1-1 LDP GR Session Establishment Process

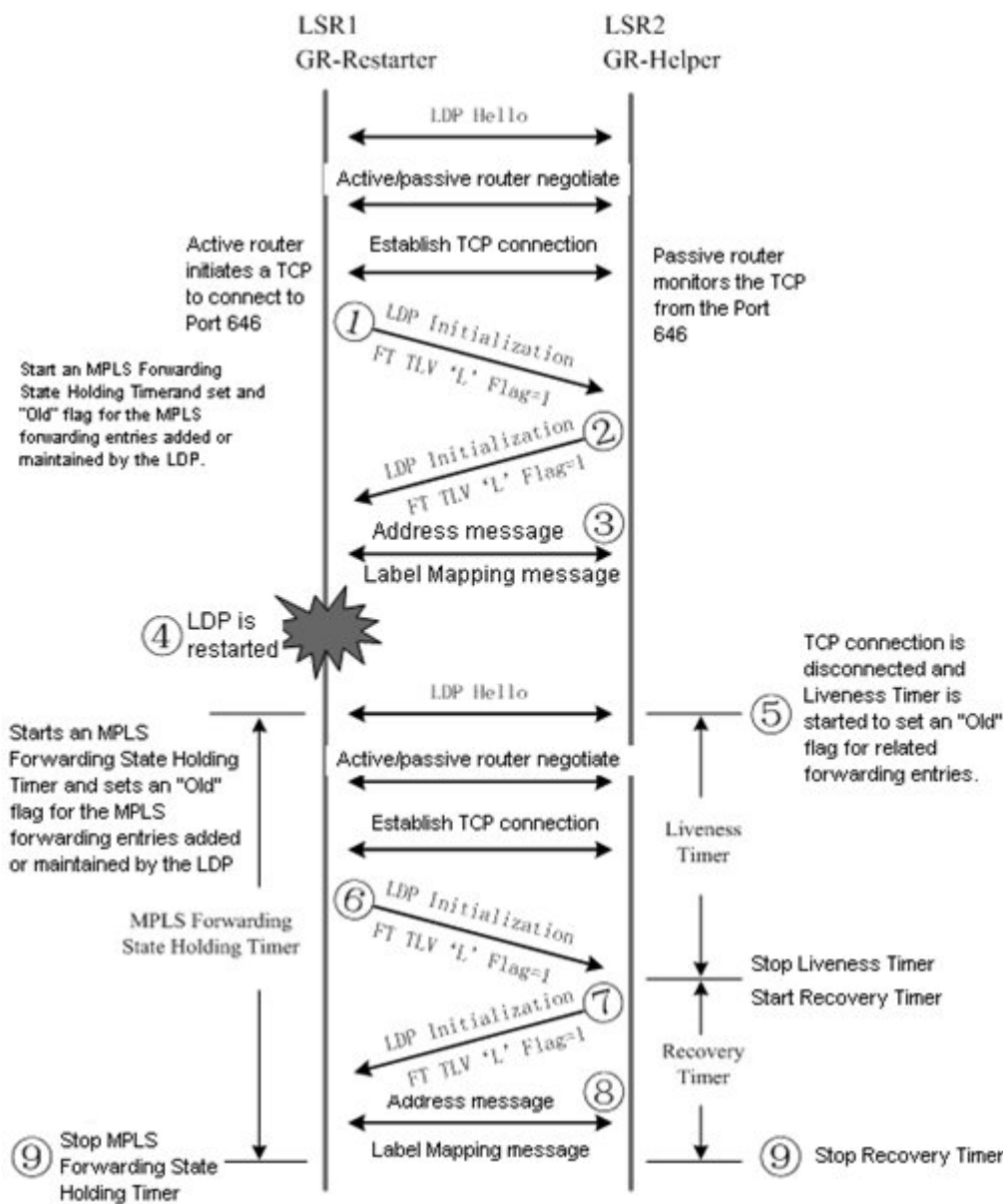

LSR 1 initiates an Initialization message that carries an optional FT Session TLV, indicating that LSR 1 itself supports LDP GR.

LSR 2 receives the Initialization message that carries the FT Session TLV and detects that itself also supports LDP GR. Therefore, LSR 2 returns an Initialization message that also carries the FT Session TLV to LSR 1. When LSR 1 receives the Initialization message from LSR 2, a GR-capable LDP session has been established.

LSR 1 and LSR 2 exchange LDP Address and Label Mapping messages with each other.

The LDP on LSR 1 is restarted for a certain reason. LSR 1 keeps all MPLS forwarding entries added or maintained by the LDP, sets an "Old" flag for these forwarding entries, and starts an MPLS Forwarding State Holding Timer.

LSR 2 with LDP GR capability detects that the GR-capable LDP session between itself and LSR 1 is disconnected, so LSR 2 keeps the MPLS forwarding entries related to this session and sets an "Old" flag for these forwarding

entries. At the same time, LSR 2 selects the smaller of the Liveness Timer configured on itself and the FT Reconnect Timeout in the received FT Session TLV to start a Liveness Timer, and keeps these "Old" forwarding entries before the Liveness Timer is triggered.

To re-establish a session with LSR 2, LSR 1 sets the Recovery Time in the FT Session TLV of the Initialization message to the remaining value of the MPLS Forwarding State Holding Timer.

Upon receipt of the Initialization message that carries the FT Session TLV from LSR 1, LSR 2 detects that Recovery Time is not 0. Therefore, LSR 2 continues to keep the "Old" forwarding entries, stops the Liveness Timer, selects the smaller of the Recovery Time configured on itself and the Recovery Time in the received FT Session TLV to start a Recovery Timer, and keeps these "Old" forwarding entries before the Recovery Timer is triggered.

LSR 1 and LSR 2 exchange LDP Address and Label Mapping messages with each other, and keep or remove the "Old" flag set for MPLS forwarding entries accordingly.

The GR process ends. LSR 1 and LSR 2 delete the "Old" MPLS forwarding entries from themselves respectively.

4.1.1.3 Protocols and Standards

The following protocols or specifications apply:

- ❖ RFC 3036: LDP Specification
- ❖ RFC 3037: LDP Applicability
- ❖ RFC 3215: LDP State Machine
- ❖ RFC 3478: Graceful Restart Mechanism for Label Distribution Protocol
- ❖ RFC 3479: Fault Tolerance for the Label Distribution Protocol (LDP)

4.1.2 Configuration

Network Environment

The GR function of the MPLS LDP can be configured to maintain the neighborhood and sessions between routers when faults occur on MPLS devices and to subsequently recover sessions and label information.

Prerequisites

Complete the following tasks before configuring MPLS LDP GR:

- ❖ Configure IGP GR.
- ❖ Configure MPLS LDP session information.

Data Preparations

Prepare the following data before configuring MPLS LDP GR:

- ❖ LDP session re-connection time
- ❖ LDP neighbor keep-alive time
- ❖ LDP session recovery time

4.1.2.1 Enabling the LDP GR Protocol

By default, the LDP GR function is disabled on a device. To enable the LDP GR function on a device, enter the privileged user mode and then run the following commands in turn:

Command	Function
Qtech# configure terminal	Enters the global configuration mode
Qtech(config)# mpls ip	Enables global MPLS forwarding  Caution This command is not applicable to forwarding on switch chips.
Qtech(config)# interface type ID	Enters the interface configuration mode
Qtech(config-if-type ID)# no switchport	Sets ports to L3 ports (Switch configuration)
Qtech(config-if-type ID)# mpls ip	Enables LDP forwarding on interfaces
Or:	
Qtech(config-if-type ID)# mpls ip	Enables LDP forwarding on interfaces (Router configuration)
Qtech(config-if-type ID)# ip ref	Enables fast forwarding on interfaces
Qtech(config-if-type ID)# label-switching	Enables MPLS packet processing on interfaces
Qtech(config)# mpls router ldp	Enters the LDP configuration mode
Qtech(config-mpls-router)# ldp router-id Loopback ID force	Sets the router ID to a loopback ID (The settings immediately take effect)
Qtech(config-mpls-router)# graceful-restart	Enables LDP GR By default, LDP GR is enabled on a device.
Qtech(config-mpls-router)# end	Exits the LDP configuration mode
Qtech# show mpls ldp graceful-restart	Shows LDP GR sessions and session parameters

To disable LDP GR on a device, run the **no graceful-restart** command on the device.



Note The existing LDP session will not be affected when LDP GR is enabled. For example, the LDP session will not restart. You must, however, restart the LDP session for LDP GR settings to take effect.

4.1.2.2 Configuring Parameters Related to LDP GR (Optional)

To configure parameters related to LDP GR on a device, enter the LDP configuration mode and then run the following commands in turn:

Command	Function
Qtech# configure terminal	Enters the global configuration mode
Qtech(config)# mpls router ldp	Enables the LDP and enters the LDP configuration mode

Qtech(config-mpls-router)# graceful-restart timer reconnect <i>seconds</i>	Sets the LDP session re-connection time By default, the LDP session reconnection time is 300 seconds.
Qtech(config-mpls-router)# graceful-restart timer neighbor-liveness <i>seconds</i>	Sets the LDP neighbor keep-alive time By default, the LDP neighbor keep-alive time is 120 seconds.
Qtech(config-mpls-router)# graceful-restart timer recovery <i>seconds</i>	Sets the LDP session recovery time By default, the LDP session recovery time is 120 seconds.
Qtech(config-mpls-router)# end	Exits the LDP configuration mode
Qtech# show mpls ldp graceful-restart	Shows LDP GR sessions and session parameters

To restore the default settings of parameters related to LDP GR, run the `no graceful-restart timer reconnect`, `no graceful-restart timer neighbor-liveness`, and `no graceful-restart timer recovery` commands.

4.1.2.3 Verification

To display LDP GR configuration and running information, run the following commands:

Command	Function
show mpls ldp graceful-restart	Shows LDP GR sessions and session parameters
show mpls ldp bindings [<i>all</i> vrf <i>vrf-name</i>] [<i>ip-address/mask</i> <i>label label</i>] [remote local]	Shows the mapping between Forwarding Equivalence Classes (FECs) and labels
show mpls ldp neighbor [<i>all</i> vrf <i>vrf-name</i>] [<i>ip-address</i>] [detail]	Shows the status of LDP neighbors

4.1.3 Configuration Example

Networking Requirements

- ❖ An MPLS network consists of Provider Edge (PE) and Provider (P) devices.
- ❖ PE and P devices support the LDP and are capable of GR.
- ❖ This example describes how to configure LDP GR on devices by taking PE 1 and a P device as an example. PE 1 is a GR-capable router and the GR restarter. The P device is a GR-aware router and the GR helper.

Topology

Figure 1-2 Network Topology for Configuring LDP GR

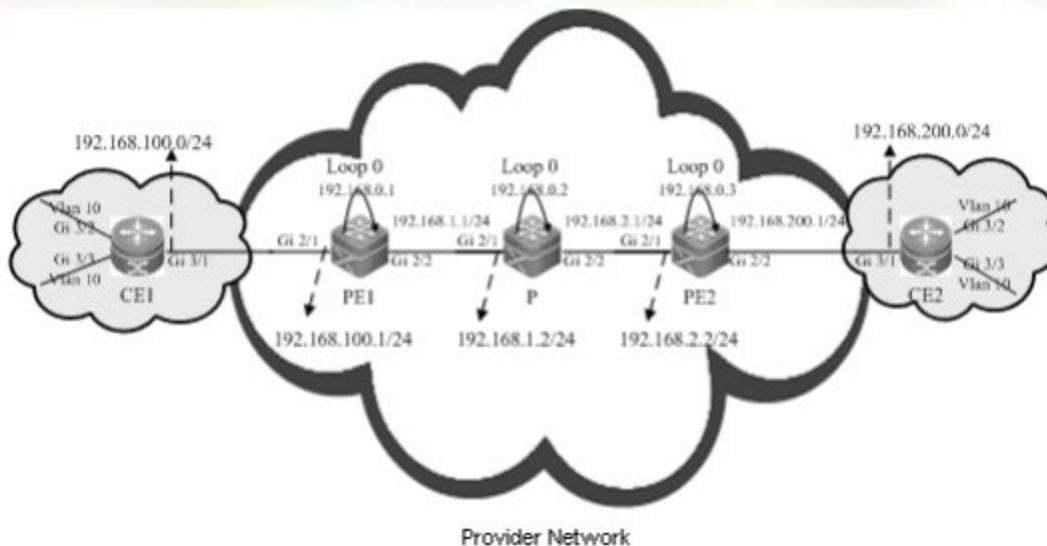

Notes

Configure PE 1 and the P device as follows:

- ❖ Configure interface IP addresses and the Open Shortest Path First (OSPF) protocol.
- ❖ Enable global MPLS packet forwarding on devices, and MPLS forwarding and the LDP on interfaces.
- ❖ Configure the LDP so that the network can forward MPLS traffic.
- ❖ Enable the LDP GR protocol.
- ❖ Configure parameters related to LDP GR.
- ❖ Restart the LDP session for the configurations to take effect.

Configuration Steps

- ❖ Configure interface IP addresses and the OSPF protocol.

Configure PE 1.

```
Qtech#configure terminal
Enter configuration commands, one per line. End with CNTL/Z.
```

The **no switchport** command is used on a switch to change to the Routed Port mode and not applicable to routers. Therefore, it does not need to be run on a router.

```
Qtech(config)#interface gigabitEthernet 2/1
Qtech(config-if-GigabitEthernet 2/1)#no switchport
Qtech(config-if-GigabitEthernet 2/1)#ip address 192.168.100.1 255.255.255.0
Qtech(config-if-GigabitEthernet 2/1)#exit
```

The **no switchport** command is run on a switch to change to the Routed Port mode and not applicable to routers. Therefore, it does not need to be run on a router.

```
Qtech(config)#interface gigabitEthernet 2/2
Qtech(config if GigabitEthernet 2/2)#no switchport
Qtech(config if GigabitEthernet 2/2)#ip address 192.168.1.1 255.255.255.0
Qtech(config if GigabitEthernet 2/2)#exit
Qtech(config)#interface loopback 0
Qtech(config Loopback 0)#ip address 192.168.0.1 255.255.255.255
Qtech(config Loopback 0)#exit
Qtech(config)#router ospf 1
Router(config router)#network 192.168.100.1 255.255.255.0 area 0
Router(config router)#network 192.168.1.1 255.255.255.0 area 0
Router(config router)#network 192.168.0.1 255.255.255.255 area 0
Router(config router)#exit
```

Configure the P device by running the same commands as those on PE 1.

- ❖ Enable global MPLS forwarding on devices, and MPLS packet forwarding and the LDP on interfaces.

Configure PE 1.

```
Qtech#configure terminal
Enter configuration commands, one per line. End with CNTL/Z.
Qtech(config)#mpls ip
```

The **ip ref** command is run a router to enable MPLS fast forwarding on the router. It does not need to be run on a switch.

```
Qtech(config)#interface gigabitEthernet 2/2
Qtech(config if GigabitEthernet 2/2)#label switching
Qtech(config if GigabitEthernet 2/2)#mpls ip
Qtech(config if GigabitEthernet 2/2)#ip ref
Router(config if GigabitEthernet 2/2)#exit
```

Configure the P device.

```
Qtech#configure terminal
Enter configuration commands, one per line. End with CNTL/Z.
Qtech(config)#mpls ip
```

The **ip ref** command is run a router to enable MPLS fast forwarding on the router. It does not need to be run on a switch.

```
Qtech(config)#interface gigabitEthernet 2/1
Qtech(config if GigabitEthernet 2/1)#label switching
Qtech(config if GigabitEthernet 2/1)#mpls ip
Qtech(config if GigabitEthernet 2/1)#ip ref
Router(config if GigabitEthernet 2/1)#exit
```

The ip ref command is run a router to enable MPLS fast forwarding on the router. It does not need to be run on a switch.

```
Qtech(config)#interface gigabitEthernet 2/2
Qtech(config if GigabitEthernet 2/2)#label switching
Qtech(config if GigabitEthernet 2/2)#mpls ip
Qtech(config if GigabitEthernet 2/2)#ip ref
Router(config if GigabitEthernet 2/2)#exit
```

❖ **Configure the LDP so that the network can forward MPLS traffic.**

Configure PE 1.

```
Qtech#configure terminal
Enter configuration commands, one per line. End with CNTL/Z.
Qtech(config)#mpls router ldp
Qtech(config mpls router)#ldp router id interface loopback 0 force
```

Configure the P device.

```
Qtech#configure terminal
Enter configuration commands, one per line. End with CNTL/Z.
Qtech(config)#mpls router ldp
Qtech(config mpls router)#ldp router id interface loopback 0 force
```

❖ **Enable the LDP GR protocol.**

Configure PE 1.

```
Qtech#configure terminal
Enter configuration commands, one per line. End with CNTL/Z.
Qtech(config)#mpls router ldp
Qtech(config mpls router)#graceful restart
```

Configure the P device.

```
Qtech#configure terminal
Enter configuration commands, one per line. End with CNTL/Z.
Qtech(config)#mpls router ldp
Qtech(config mpls router)#graceful restart
```

❖ **Configure parameters related to LDP GR.**

Configure PE 1.

```
Qtech#configure terminal
Enter configuration commands, one per line. End with CNTL/Z.
Qtech(config)#mpls router ldp
```

Set the LDP reconnection time to 300 seconds, LDP neighbor keep-alive time to 120 seconds, and LDP recovery time to 120 seconds.

```
Qtech(config mpls router)#graceful restart timer reconnect 300
Qtech(config mpls router)#graceful restart timer neighbor liveness 120
Qtech(config mpls router)#graceful restart timer recovery 120
Qtech(config mpls router)#exit
```

Configure the P device.

```
Qtech#configure terminal
Enter configuration commands, one per line. End with CNTL/Z.
Qtech(config)#mpls router ldp
```

Set the LDP reconnection time to 300 seconds, LDP neighbor keep-alive time to 120 seconds, and LDP recovery time to 120 seconds.

```
Qtech(config mpls router)#graceful restart timer reconnect 300
Qtech(config mpls router)#graceful restart timer neighbor liveness 120
Qtech(config mpls router)#graceful restart timer recovery 120
Qtech(config mpls router)#exit
```

❖ Restart the LDP session for the configurations to take effect.

Restart the LDP session on PE 1.

```
Qtech#clear mpls ldp neighbor all
```

Restart the LDP session on the PE device.

```
Qtech#clear mpls ldp neighbor all
```

Verification

Run the following commands to show configurations on PE 1:

Show LDP GR information on PE 1.

```
Qtech#show mpls ldp graceful restart
Default VRF:
  LDP Graceful Restart is enabled
  Neighbor Liveness Timer: 120 seconds
  Max Recovery Time: 120 seconds
  Forwarding State Holding Time: 300 seconds
  Down Neighbor Database (1 records):
    Peer LDP Ident: 192.168.0.2:0; Local LDP Ident: 192.168.0.1:0
      Status: recovering (86 seconds left)
      Address list contains 3 addresses:
        192.168.1.2  192.168.2.1  192.168.0.2
  Graceful Restart enabled Sessions:
    Peer LDP Ident: 192.168.0.2:0, State: estab
```

Show LDP GR neighbor information on PE 1.

```
Qtech#show mpls ldp neighbor
Default VRF:
  Peer LDP Ident: 192.168.0.2:0; Local LDP Ident: 192.168.0.1:0
  TCP connection: 192.168.0.2.15532 192.168.0.1.646
  State: OPERATIONAL; Msgs sent/rcv: 23/27; UNSOLICITED
  Up time: 00:04:12
  Graceful Restart enabled; Peer reconnect time (msecs): 0
```

Show LDP binding information on PE 1.

```
Router#show mpls ldp bindings
Default VRF:
  lib entry: 192.168.0.2/32
    local binding: to lsr: 192.168.0.2:0, label: 1024
    remote binding: from lsr: 192.168.0.2:0, label: imp null stale
  lib entry: 192.168.1.2/24
    local binding: to lsr: 192.168.0.2:0, label: 1025
    remote binding: from lsr: 192.168.0.2:0, label: imp null stale
  lib entry: 192.168.2.1/24
    local binding: to lsr: 192.168.0.2:0, label: 1026
    remote binding: from lsr: 192.168.0.2:0, label: imp null stale
```

4.2 L3VPN GR

4.2.1 Overview

L3 VPN GR, also known as VPN GR, is a mechanism to implement uninterrupted forwarding of Virtual Private Network (VPN) services. It ensures that the data of VPN services can still be normally forwarded even when the control plane on a device fails, thus protecting VPN services on the network.

The following prerequisites must be met for VPN GR:

- ❖ Devices support 1+1 management board redundancy.
- ❖ Devices support uninterrupted forwarding of routing protocols.
- ❖ Devices support the BGP/MPLS GR protocol.
- ❖ Devices support the LDP GR protocol.

The objectives of VPN GR are to:

- ❖ Minimize routing protocol flapping during master/slave management board switchover
- ❖ Minimize the impact on VPN services
- ❖ Minimize Single-Point Failures (SPFs) on access devices and improve VPN network reliability

- ❖ Minimize the packet loss rate of VPN traffic
-



Note GR must be supported in unicast routing to implement uninterrupted forwarding of routing protocols. In other words, the device must support OSPF GR, IS-IS GR, or BGP GR.

4.2.1.1 Basic Concepts

GR Routers Classified by Capability

GR routers are classified by capability into GR-capable routers, GR-aware routers, and GR-unaware routers.

- ❖ **GR-Capable Router**

A GR-capable router is a router that has GR capability. In general, a GR-capable router is equipped with two management boards which work in 1+1 master/slave mode. The GR-capable router can send an advertisement packet to neighboring routers during master/slave switchover of the management boards, so that neighboring routers keep forwarding entries related to the GR-capable router. After master/slave switchover, routing tables are re-established without causing route flapping or changing the packet forwarding path, thus guaranteeing uninterrupted data forwarding in the system.

- ❖ **GR-Aware Router**

A GR-aware router is a router that has GR detection capability. Not necessarily equipped with two management boards, a GR-aware router is able to detect that its neighbors are experiencing GR and to assist its neighbors to complete GR.

- ❖ **GR-Unaware Router**

A GR-unaware router is a router that does not have GR detection capability. It cannot detect that its neighbors are experiencing GR, cannot assist its neighbors to complete GR, and does not have GR capability, generally because the system software does not provide the GR feature or the GR feature is disabled.

GR Routers Classified by Role

GR routers are classified by role during router restart into GR restarters and GR helpers.

- ❖ **GR Restarter**

The GR restarter has GR capability and its restart is triggered by administrators or faults.

- ❖ **GR Helper**

The GR helper is a neighbor of the GR restarter. It must be at least a GR-aware router.

4.2.1.2 Working Principles

Both the control plane and the forwarding plane on a conventional device are implemented by the same processor which simultaneously maintains a routing table and a forwarding table. A multi-processor architecture, however, can be employed on high-end and mid-range devices to attain higher forwarding performance and reliability. The processors of control modules such as the routing protocol module are located on a master management board, whereas those responsible for data forwarding are located on line cards. Therefore, the control plane and the forwarding plane are separated from each other so that data forwarding on line cards is not affected when the control plane is restarted. This technology provides a prerequisite for the implementation of GR. The GR-capable routers mentioned in this document are such routers where the control plane and the forwarding plane are separated from each other.

Assume that a VPN network shown in Figure 1-3 exists. It has the following features:

- ❖ Customer Edge (CE) devices represent a customer network. The Interior Gateway Protocol (IGP) or Exterior Border Gateway Protocol (eBGP) runs on the CE devices.
- ❖ PE and P devices form a provider network. The IGP runs on these devices.
- ❖ Public network tunnels and Label Switching Paths (LSPs) are established via the LDP between PE 1, PE 2, and the P device.
- ❖ Private network tunnels are established via the Interior Border Gateway Protocol (iBGP) between PE 1 and PE 2.
- ❖ The IGP, BGP, and LDP have GR capability.
- ❖ PE devices are GR-capable routers, and the P device is a GR-aware router.



Note

For details about IGP GR, BGP GR, and LDP GR, see related sections in *OSPF*, *BGP*, and *LDP GR*.

Figure 1-3 VPN Network Topology

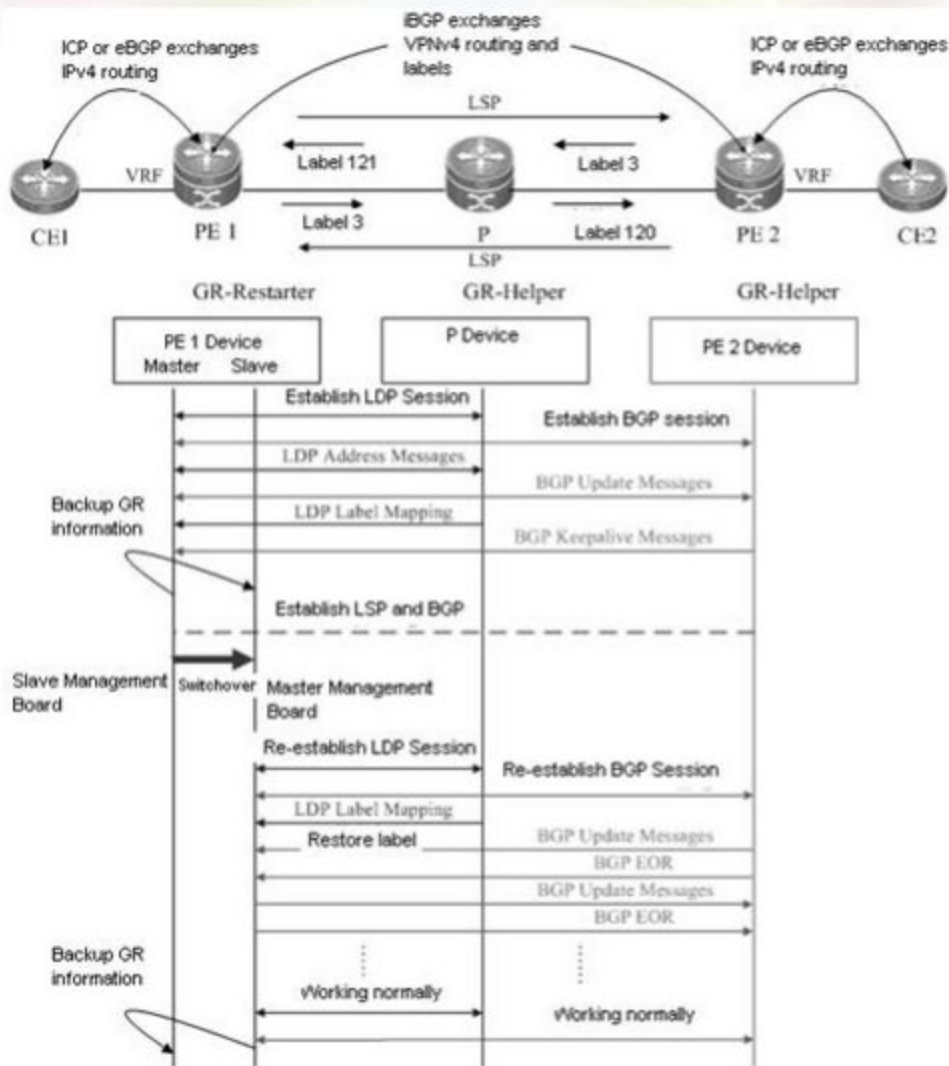

In this configuration instance, PE 1 is taken as an example to describe the GR process. Master/slave management board switchover occurs on PE 1. PE 1 works as a GR restarter, whereas PE 2 and the P device work as GR helpers. When master/slave management board switchover occurs on PE 1, a certain procedure applies. The procedure consists of the following three phases:

❖ Before Master/Slave Management Board Switchover

PE 1 performs IGP GR or eBGP GR negotiation with the connected CE device. It also performs IGP GR and LDP GR negotiation with the P device, and iBGP GR negotiation with PE 2.

PE 1 sends an Initialization message that carries the optional FT Session TLV to the P device to establish a GR-capable LDP session. After the LDP session is established, they exchange LDP Address and Label Mapping messages with each other, so that GR-capable LSPs are established for data forwarding.

PE 1 sends an Open message to PE 2 to establish a GR-capable iBGP session. The Open message carries GR capability parameters <AFI=IPv4, SAFI=Unicast> and <AFI=IPv4, SAFI=VPNv4>.

The master management board, when working normally, must back up GR information to the slave management board. The GR backup enables the system to access these original data during GR protocol restart and apply the data to the protocol GR process after master/slave management board switchover.

❖ During Master/Slave Management Board Switchover

GR information on PE 1 has been backed up to the slave management board. The major task of PE 1 in this phase is to perform master/slave management board switchover.

The P device detects that the Transfer Control Protocol (TCP) session is down, and therefore sets an "Old" flag for the respective LSPs. It also starts a forwarding entry aging timer and continues to forward data before this aging timer expires.

PE 2 detects that the TCP connection is broken, so it immediately marks the route learned from PE 1 as "Old" and starts a restart timer for PE 1. If PE 2 does not receive an Open message within the restart timer, it deletes the "Old" flag previously set for the route. If PE 2 receives an Open message, it deletes the restart timer. In this period of time, PE 1 and PE 2 continue to forward traffic along the original route.

❖ After Master/Slave Management Board Switchover

The slave management board on PE 1 becomes the new master management board, and the original master management board becomes the new slave management board. The new master management board starts to check the GR information previously backed up and determines whether forwarding entries before the restart are retained. Then the Command Line Interface (CLI) configuration initialization process and the GR process continue. During IGP GR, BGP GR, and LDP GR, all the devices will send notification messages to all IGP, BGP, and LDP neighbors for connection re-establishment.

1. IGP Convergence

PE 1 sends an Initialization message that carries the FT Session TLV to the P device, and re-establishes a session upon receiving a response to obtain topology and routing information. Then PE 1 re-computes the routing table, deletes the "Old" routes, and therefore completes IGP convergence.

2. BGP Processing

PE 1 and CE 1 exchange routing information with each other. Subsequently, PE 1 updates its routing table and forwarding entries according to the new routing and forwarding information, substitutes invalid routes, and therefore completes BGP convergence.

PE 1 and PE 2 start to re-establish a BGP session with each other. First, PE 1 sends an Open message to PE 2. The Open message carries GR capability parameters. Secondly, PE 1 receives and processes an Update message from PE 2. These messages carry IP prefix information. PE 1 does

not start BGP route preference until receiving an EOR flag from PE2. Then PE 1 sends an Update message that carries prefix information to PE 2. After sending the Update message, PE 1 sends the EOR flag to PE 2. Upon receiving the EOR flag, PE 2 also starts BGP route preference. Therefore, network convergence is accomplished by such a procedure.

3. LDP Processing

PE 1 sends an Initialization message that carries the FT Session TLV to the neighboring P device. A GR-capable LDP session is established after the P device receives the Initialization message. Then PE 1 and the P device exchange LDP Address and Label Mapping messages again with each other, and keep or remove the "Old" flag set for MPLS forwarding entries accordingly. When the GR process ends, both devices delete the "Old" MPLS forwarding entries from themselves respectively.



Note

The preceding IGP GR, BGP GR, and LDP GR processes do not follow a strict priority sequence. In terms of route convergence, unicast routes converge first and converged routes are advertised to the LDP.

Before all protocols complete the GR process, only Routing Information Base (RIB) information on the master management board is updated. The Forwarding Information Base (FIB) information on interface boards will not be updated.

The FIB information on interface boards is updated only after all protocols complete the GR process.

4.2.1.3 Protocols and Standards

The following protocols or specifications apply:

- ❖ RFC 4724: Graceful Restart Mechanism for BGP
- ❖ RFC 4781: Graceful Restart Mechanism for BGP with MPLS

4.2.2 Configuration

Network Environment

It is necessary to configure L3VPN GR for L3VPN applications on service bearing devices on an MPLS network, so that data forwarding is not interrupted during master/slave management board switchover on devices, thus guaranteeing traffic continuity.



Note

The GR capability does not guarantee traffic continuity when master/slave management board switchover also occurs on neighboring devices.

Prerequisites

Complete the following tasks before configuring L3VPN GR:

- ❖ Build an L3VPN environment and configure L3VPN.
- ❖ Ensure that devices support management board redundancy.
- ❖ Ensure that the IGP has GR capability.
- ❖ Ensure that the BGP has GR capability.
- ❖ Ensure that the LDP has GR capability.



Note For details about L3VPN configuration, see related sections in *BGP/MPLS VPN Configuration*.

Data Preparations

Prepare the following data before configuring L3VPN GR:

- ❖ IGP GR parameters
- ❖ BGP GR parameters
- ❖ LDP GR parameters

4.2.2.1 Configuring IGP GR



Note For details about IGP GR configuration, see related sections in *OSPF*.

4.2.2.2 Configuring BGP GR



Note For details about BGP GR configuration, see related sections in *BGP*.

4.2.2.3 Configuring LDP GR



Note For details about LDP GR configuration, see section 1.1 "LDP GR" in this document.

4.2.2.4 Verification

To display L3VPN GR configuration and running information, run the following commands:

Command	Function
<code>show ip vrf [vrf_name]</code>	Shows VRF configuration information

<code>show ip bgp vpnv4 { all rd route-distinguish vrf vrf_name } [network-address] [summary] [neighbor] [label]</code>	Shows VPN routing information
<code>show ip bgp summary</code>	Shows the status of all BGP connections
<code>show ip route vrf vrf_name [A.B.C.D bgp connected isis ospf rip static weight]</code>	Shows VRF routing information
<code>show mpls ldp graceful-restart [all vrf vrf-name]</code>	Shows LDP GR sessions and session parameters



Note All the preceding commands can be configured in any mode except for the user mode.

4.2.3 Configuration Example

Networking Requirements

- ❖ CE devices represent a customer network. The IGP or eBGP runs on the CE devices.
- ❖ PE and P devices form a provider network. The IGP runs on these devices.
- ❖ Public network tunnels and LSPs are established via the LDP between PE 1, PE 2, and the P device.
- ❖ Private network tunnels are established via the iBGP between PE 1 and PE 2.
- ❖ The IGP, BGP, and LDP have GR capability.
- ❖ PE devices are GR-capable routers, and the P device is a GR-aware router.

Topology

Figure 1-4 Network Topology for Configuring L3VPN GR

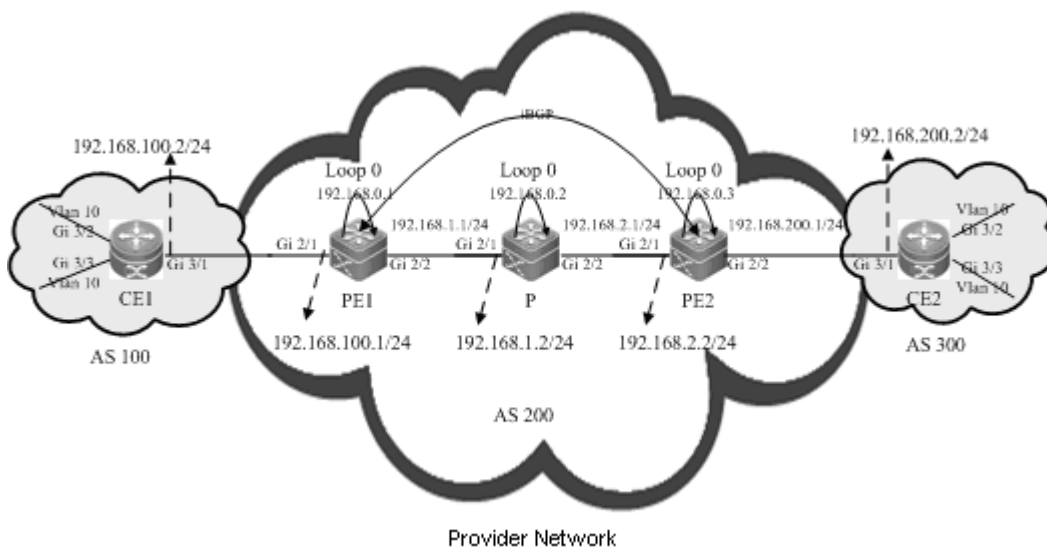

Notes

Configure PE 1, PE 2, and the P device as follows:

- ❖ Configure VRF.
- ❖ Configure interface IP addresses and the OSPF protocol.
- ❖ Enable global MPLS forwarding on devices, and MPLS packet forwarding and the LDP on interfaces.
- ❖ Configure the LDP so that the network can forward MPLS traffic.
- ❖ Enable the LDP GR protocol, and configure parameters related to LDP GR.
- ❖ Configure L3VPN.
- ❖ Enable the BGP GR protocol.
- ❖ Restart the LDP session for the configurations to take effect.

Configuration Steps

- ❖ Configure VRF.

Configure PE 1.

```
Qtech#configure terminal
Enter configuration commands, one per line. End with CNTL/Z.
```

Define VRF.

```
Qtech(config)#ip vrf 10
Qtech(config vrf)#rd 1:100
Qtech(config vrf)#route target both 1:100
Qtech(config vrf)#exit
```

Configure the P device. VRF configuration is not necessary on the P device.

Configure PE 2 by running the same commands as those on PE 1.

- ❖ Configure interface IP addresses and the OSPF protocol.

Configure PE 1.

```
Qtech#configure terminal
Enter configuration commands, one per line. End with CNTL/Z.
```

The **no switchport** command is run on a switch to change to the Routed Port mode and not applicable to routers. Therefore, it does not need to be run on a router.

```
Qtech(config)#interface gigabitEthernet 2/1
Qtech(config if GigabitEthernet 2/1)#no switchport
Qtech(config if GigabitEthernet 2/1)#ip vrf forwarding 10
Qtech(config if GigabitEthernet 2/1)#ip address 192.168.100.1 255.255.255.0
```

```
Qtech(config if GigabitEthernet 2/1)#exit
```

The **no switchport** command is run on a switch to change to the Routed Port mode and not applicable to routers. Therefore, it does not need to be run on a router.

```
Qtech(config)#interface gigabitEthernet 2/2
Qtech(config if GigabitEthernet 2/2)#no switchport
Qtech(config if GigabitEthernet 2/2)#ip address 192.168.1.1 255.255.255.0
Qtech(config if GigabitEthernet 2/2)#exit
```

Configure a loopback interface named **loopback 0**.

```
Qtech(config)#interface loopback 0
Qtech(config Loopback 0)#ip address 192.168.0.1 255.255.255.255
Qtech(config Loopback 0)#exit
```

Activate the OSPF protocol and enter the OSPF mode.

```
Qtech(config)#router ospf 10
Qtech(config router)#network 192.168.0.1 255.255.255.255 area 0
Qtech(config router)#network 192.168.1.0 255.255.255.0 area 0
Qtech(config router)#end
```

Configure the P device.

```
Qtech#configure terminal
Enter configuration commands, one per line. End with CNTL/Z.
```

The **no switchport** command is run on a switch to change to the Routed Port mode and not applicable to routers. Therefore, it does not need to be run on a router.

```
Qtech(config)#interface gigabitEthernet 2/1
Qtech(config if GigabitEthernet 2/1)#no switchport
Qtech(config if GigabitEthernet 2/1)#ip address 192.168.1.2 255.255.255.0
Qtech(config if GigabitEthernet 2/1)#exit
```

The **no switchport** command is run on a switch to change to the Routed Port mode and not applicable to routers. Therefore, it does not need to be run on a router.

```
Qtech(config)#interface gigabitEthernet 2/2
Qtech(config if GigabitEthernet 2/2)#no switchport
Qtech(config if GigabitEthernet 2/2)#ip address 192.168.2.1 255.255.255.0
Qtech(config if GigabitEthernet 2/2)#exit
```

Configure a loopback interface named **loopback 0**.

```
Qtech(config)#interface loopback 0
Qtech(config Loopback 0)#ip address 192.168.0.2 255.255.255.255
Qtech(config Loopback 0)#exit
```

Activate the OSPF protocol and enter the OSPF mode.

```
Qtech(config)#router ospf 10
Qtech(config router)#network 192.168.1.0 255.255.255.0 area 0
Qtech(config router)#network 192.168.2.0 255.255.255.0 area 0
Qtech(config router)#network 192.168.0.2 255.255.255.255 area 0
Qtech(config router)#end
```

Configure PE 2 by running the same commands as those on PE 1.

- ❖ Enable global MPLS forwarding on devices, and MPLS packet forwarding and the LDP on interfaces.

Configure PE 1.

```
Qtech#configure terminal
Enter configuration commands, one per line. End with CNTL/Z.
Qtech(config)#mpls ip
```

The **ip ref** command is run a router to enable MPLS fast forwarding on the router. It does not need to be run on a switch.

```
Qtech(config)#interface gigabitEthernet 2/2
Qtech(config if GigabitEthernet 2/2)#label switching
Qtech(config if GigabitEthernet 2/2)#mpls ip
Qtech(config if GigabitEthernet 2/2)#ip ref
Router(config if GigabitEthernet 2/2)#exit
```

Configure the P device.

```
Qtech#configure terminal
Enter configuration commands, one per line. End with CNTL/Z.
Qtech(config)#mpls ip
```

The **ip ref** command is run a router to enable MPLS fast forwarding on the router. It does not need to be run on a switch.

```
Qtech(config)#interface gigabitEthernet 2/1
Qtech(config if GigabitEthernet 2/1)#label switching
Qtech(config if GigabitEthernet 2/1)#mpls ip
Qtech(config if GigabitEthernet 2/1)#ip ref
Router(config if GigabitEthernet 2/1)#exit
```

The **ip ref** command is run a router to enable MPLS fast forwarding on the router. It does not need to be run on a switch.

```
Qtech(config)#interface gigabitEthernet 2/2
Qtech(config if GigabitEthernet 2/2)#label switching
Qtech(config if GigabitEthernet 2/2)#mpls ip
Qtech(config if GigabitEthernet 2/2)#ip ref
Router(config if GigabitEthernet 2/2)#exit
```

Configure PE 2 by running the same commands as those on PE 1.

❖ Configure the LDP so that the network can forward MPLS traffic.

Configure PE 1.

```
Qtech#configure terminal
Enter configuration commands, one per line. End with CNTL/Z.
Qtech(config)#mpls router ldp
Qtech(config mpls router)#ldp router id interface loopback 0 force
```

Configure the P device.

```
Qtech#configure terminal
Enter configuration commands, one per line. End with CNTL/Z.
Qtech(config)#mpls router ldp
Qtech(config mpls router)#ldp router id interface loopback 0 force
```

Configure PE 2.

```
Qtech#configure terminal
Enter configuration commands, one per line. End with CNTL/Z.
Qtech(config)#mpls router ldp
Qtech(config mpls router)#ldp router id interface loopback 0 force
```

Enable the LDP GR protocol, and configure parameters related to LDP GR.

Configure PE 1.

```
Qtech#configure terminal
Enter configuration commands, one per line. End with CNTL/Z.
Qtech(config)#mpls router ldp
Qtech(config mpls router)#graceful restart
```

Set the LDP reconnection time to 300 seconds, LDP neighbor keep-alive time to 120 seconds, and LDP recovery time to 120 seconds.

```
Qtech(config mpls router)#graceful restart timer reconnect 300
Qtech(config mpls router)#graceful restart timer neighbor liveness 120
Qtech(config mpls router)#graceful restart timer recovery 120
Qtech(config mpls router)#exit
```

Configure the P device.

```
Qtech#configure terminal
Enter configuration commands, one per line. End with CNTL/Z.
Qtech(config)#mpls router ldp
Qtech(config mpls router)#graceful restart
```

Set the LDP reconnection time to 300 seconds, LDP neighbor keep-alive time to 120 seconds, and LDP recovery time to 120 seconds.

```
Qtech(config mpls router)#graceful restart timer reconnect 300
Qtech(config mpls router)#graceful restart timer neighbor liveness 120
Qtech(config mpls router)#graceful restart timer recovery 120
Qtech(config mpls router)#exit
```

Configure PE 2 by running the same commands as those on PE 1.

❖ Configure L3VPN.

Configure PE 1.

```
Qtech#configure terminal
Enter configuration commands, one per line. End with CNTL/Z.
```

Configure the eBGP peer CE.

```
Qtech(config)#router bgp 200
Qtech(config router)#address family ipv4 vrf 10
Qtech(config router af)#neighbor 192.168.100.2 remote as 100
Qtech(config router af)#neighbor 192.168.100.2 update source GigabitEthernet 2/1
Qtech(config router af)#neighbor 192.168.200.2 activate
Qtech(config router af)#exit address family
Qtech(config router)#exit
```

Configure the iBGP peer PE 2.

```
Qtech(config router)#address family ipv4
Qtech(config router af)#neighbor 192.168.0.3 remote as 200
Qtech(config router af)#neighbor 192.168.0.3 update source loopback 0
Qtech(config router af)#neighbor 192.168.0.3 activate
Qtech(config router af)#exit address family
Qtech(config router)#address family vpnv4 unicast
Qtech(config router af)#neighbor 192.168.0.3 activate
Qtech(config router af)#exit address family
Qtech(config router)#exit
```

Configure the P device. L3VPN configuration is not necessary on the P device.

Configure PE 2 by running the same commands as those on PE 1.

❖ Enable the BGP GR protocol.

Configure PE 1.

```
Qtech#configure terminal
Enter configuration commands, one per line. End with CNTL/Z.
```

Enable the BGP and enter the BPG configuration mode.

```
Qtech(config)#router bgp 200
```

Enable BGP GR.

```
Qtech(config router)#bgp graceful restart
```

Configure the P device. BGP GR does not need to be enabled on the P device.

Configure PE 2 by running the same commands as those on PE 1.

Restart the LDP session for the configurations to take effect.

Restart the LDP session on PE 1.

```
Qtech#clear mpls ldp neighbor all
```

Restart the LDP session on the PE device.

```
Qtech#clear mpls ldp neighbor all
```

Restart the LDP session on PE 1.

```
Qtech#clear mpls ldp neighbor all
```

Verification

Run the following commands to show configurations on PE 1:

Show LDP GR information on PE 1.

```
Qtech#show mpls ldp graceful restart
Default VRF:
  LDP Graceful Restart is enabled
  Neighbor Liveness Timer: 120 seconds
  Max Recovery Time: 120 seconds
  Forwarding State Holding Time: 300 seconds
  Down Neighbor Database (1 records):
    Peer LDP Ident: 192.168.0.2:0; Local LDP Ident: 192.168.0.1:0
    Status: recovering (86 seconds left)
    Address list contains 3 addresses:
      192.168.0.2  192.168.1.2  192.168.2.1
  Graceful Restart enabled Sessions:
    Peer LDP Ident: 192.168.0.2:0, State: estab
```

Show BGP GR information on PE 1.

```
Qtech#show bgp vpnv4 unicast all neighbor
BGP neighbor is 192.168.0.3, remote AS 200, internal link
BGP version 4, remote router ID 192.168.0.3
BGP state = Established, up for 02:49:47
Last read 00:00:47, hold time is 180, keepalive interval is 60 seconds
Neighbor capabilities:
Route refresh: advertised and received(new)
Address family VPNv4 Unicast: advertised and received
```

```
Graceful Restart Capability: advertised and received
Remote Restart timer is 120 seconds
Address families preserved by peer:
VPNv4 Unicast
```

4.3 L2VPN GR



Note L2VPN GR described in this section means GR for Virtual Pseudo Wire Service (VPWS) and Virtual Private LAN Service (VPLS).

4.3.1 Overview

For VPWS and VPLS services, public network tunnels are established based on basic MPLS network services. In addition, the extended LDP is used to distribute VC labels for the establishment of virtual lines. Therefore, extended LDP GR must also be implemented to guarantee uninterrupted forwarding of VPWS and VPLS services. Extended LDP GR is implemented according to the same working principles as basic LDP GR, except that the MPLS forwarding entries to be backed up are different. For this reason, extended LDP GR and basic LDP GR can be uniformly implemented.



Note For details about LDP GR and configuration methods, see section 1.1 "LDP GR" in this document.



Note The working principles of VPWS GR are described in the following text. VPLS GR is beyond the scope of this document.

VPWS GR is a mechanism to implement uninterrupted forwarding of VPWS services. It ensures that the data of VPWS services can still be normally forwarded even when the control plane on a device fails, thus protecting VPWS services on the network. The following prerequisites must be met for VPWS GR:

- ❖ Devices support 1+1 management board redundancy.
- ❖ Devices support uninterrupted forwarding of routing protocols.
- ❖ Devices support the LDP GR protocol.

The objectives of VPWS GR are to:

- ❖ Minimize routing protocol flapping during master/slave management board switchover
- ❖ Minimize the impact on VPWS services
- ❖ Minimize SPFs on access devices and improve VPWS network reliability

- ❖ Minimize the packet loss rate of VPWS traffic
-



Note GR must be supported in unicast routing to implement uninterrupted forwarding of routing protocols. In other words, the device must support OSPF GR, IS-IS GR, or BGP GR.

4.3.1.1 Basic Concepts

GR Routers Classified by Capability

GR routers are classified by capability into GR-capable routers, GR-aware routers, and GR-unaware routers.

- ❖ **GR-Capable Router**

A GR-capable router is a router that has GR capability. In general, a GR-capable router is equipped with two management boards which work in 1+1 master/slave mode. The GR-capable router can send an advertisement packet to neighboring routers during master/slave switchover of the management boards, so that neighboring routers keep forwarding entries related to the GR-capable router. After master/slave switchover, routing tables are re-established without causing route flapping or changing the packet forwarding path, thus guaranteeing uninterrupted data forwarding in the system.

- ❖ **GR-Aware Router**

A GR-aware router is a router that has GR detection capability. Not necessarily equipped with two management boards, a GR-aware router is able to detect that its neighbors are experiencing GR and to assist its neighbors to complete GR.

- ❖ **GR-Unaware Router**

A GR-unaware router is a router that does not have GR detection capability. It cannot detect that its neighbors are experiencing GR, cannot assist its neighbors to complete GR, and does not have GR capability, generally because the system software does not provide the GR feature or the GR feature is disabled.

GR Routers Classified by Role

GR routers are classified by role during router restart into GR restarters and GR helpers.

- ❖ **GR Restarter**

The GR restarter has GR capability and its restart is triggered by administrators or faults.

- ❖ **GR Helper**

The GR helper is a neighbor of the GR restarter. It must be at least a GR-aware router.

4.3.1.2 Working Principles

Both the control plane and the forwarding plane on a conventional device are implemented by the same processor which simultaneously maintains a routing table and a forwarding table. A multi-processor architecture, however, can be employed on high-end and mid-range devices to attain higher forwarding performance and reliability. The processors of control modules such as the routing protocol module are located on a master management board, whereas those responsible for data forwarding are located on line cards. Therefore, the control plane and the forwarding plane are separated from each other so that data forwarding on line cards is not affected when the control plane is restarted. This technology provides a prerequisite for the implementation of GR. The GR-capable routers mentioned in this document are such routers where the control plane and the forwarding plane are separated from each other.

Assume that a VPWS network shown in Figure 1-5 exists. It has the following features:

- ❖ CE devices represent a customer network. The IGP runs on the CE devices.
- ❖ PE and P devices form a provider network. The IGP and LDP run on these devices.
- ❖ Public network tunnels and LSPs are established via the LDP between PE 1, PE 2, and the P device.
- ❖ Private network tunnels are established via the LDP between PE 1 and PE 2.
- ❖ The IGP and LDP have GR capability.
- ❖ PE devices are GR-capable routers, and the P device is a GR-aware router.



Note

For details about IGP GR and LDP GR, see related sections in *OSPF* and *LDP GR*.

Figure 1-5 VPWS Network Topology

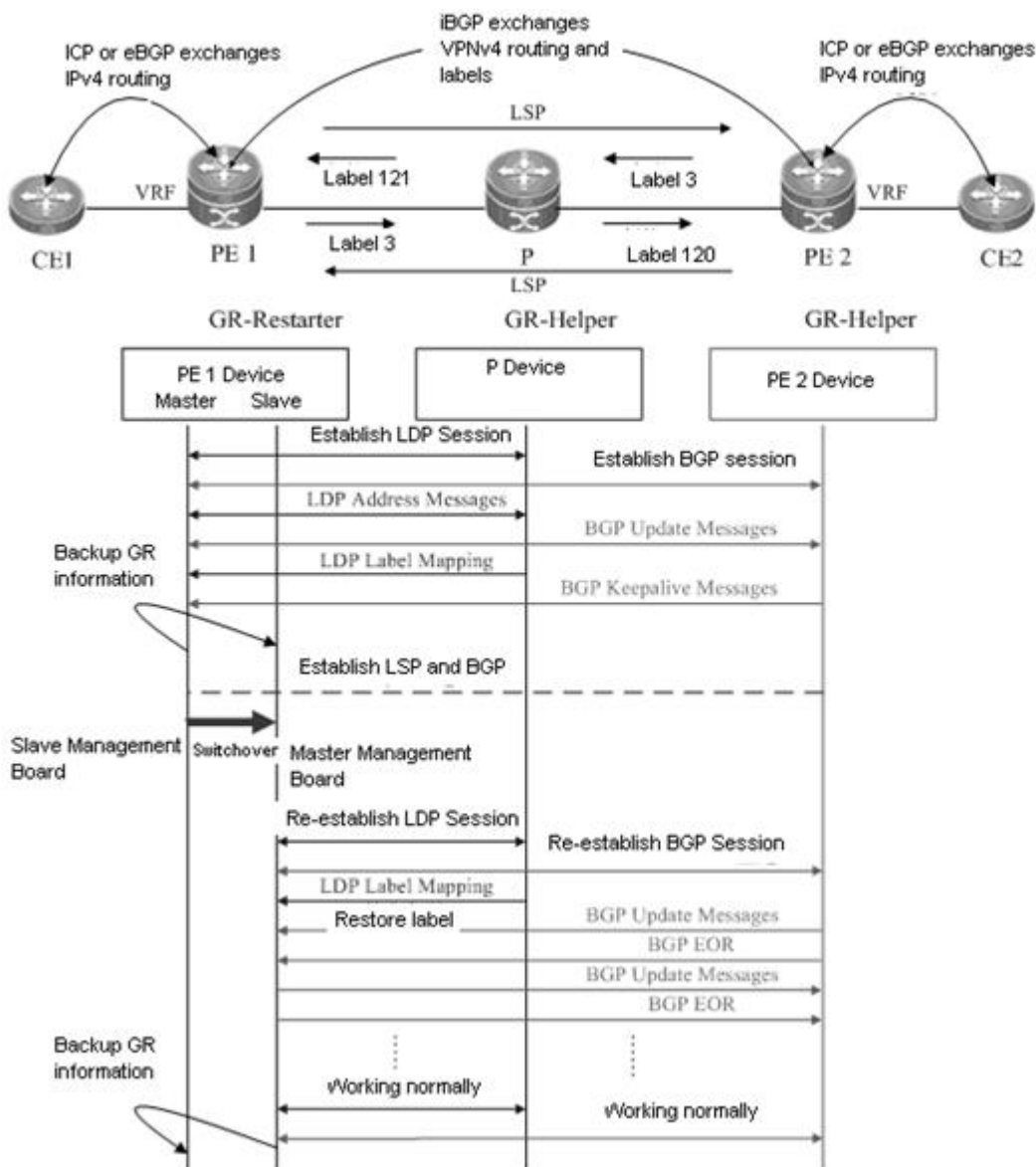

In this configuration instance, PE 1 is taken as an example to describe the GR process. Master/slave management board switchover occurs on PE 1. PE 1 works as a GR restarter, whereas PE 2 and the P device work as GR helpers. When master/slave management board switchover occurs on PE 1, a certain procedure applies. The procedure consists of the following three phases:

Before Master/Slave Management Board Switchover

PE 1 performs LDP GR and IGP GR negotiation with the P device. It also performs IGP GR negotiation with the connected CE device, and extended LDP GR negotiation with PE 2. PE 1 sends

an Initialization message that carries the optional FT Session TLV to the P device and PE 2 to establish a GR-capable LDP session.

After the LDP session is established, they exchange LDP Address and Label Mapping messages with each other, so that GR-capable LSPs are established for data forwarding.

The master management board, when working normally, must back up GR information to the slave management board so as to support GR.

During Master/Slave Management Board Switchover

GR information on PE 1 has been backed up to the slave management board. The major task of PE 1 in this phase is to perform master/slave management board switchover.

The P device and PE 2 detect that the TCP session is down, and therefore set an "Old" flag for the respective LSPs. They also start a forwarding entry aging timer and continue to forward data before this aging timer expires. The working process on CEs is similar, except that it is an IGP GR process.

After Master/Slave Management Board Switchover

The slave management board on PE 1 becomes the new master management board, and the original master management board becomes the new slave management board. The new master management board starts to check the GR information previously backed up and determines whether forwarding entries before the restart are retained. Then the CLI configuration initialization process and the GR process continue. During LDP GR and IGP GR, all the devices will send notification messages to all IGP and LDP neighbors for connection re-establishment.

- ❖ IGP Convergence
- ❖ PE 1 sends an Initialization message that carries the FT Session TLV to the P device, and re-establishes a session upon receiving a response to obtain topology and routing information. Then PE 1 re-computes the routing table, deletes the "Old" routes, and therefore completes IGP convergence.
- ❖ LDP Processing
- ❖ PE 1 sends an Initialization message that carries the FT Session TLV to the neighboring P device and PE 2. A GR-capable LDP session is established after the P device and PE 2 receive the Initialization message. Then the devices exchange LDP Address and Label Mapping messages again with each other, and keep or remove the "Old" flag set for MPLS forwarding entries accordingly. When the GR process ends, the P device, PE 1, and PE 2 delete the "Old" MPLS forwarding entries from themselves respectively.



Note

The preceding IGP GR and LDP GR processes do not follow a strict priority sequence. In terms of route convergence, IGP routes converge first and converged routes are advertised to the LDP.

Before all protocols complete the GR process, only RIB information on the master management board is updated. The FIB information on interface boards will not be updated.

The FIB information on interface boards is updated only after all protocols complete the GR process.

4.3.1.3 Protocols and Standards

The following protocols or specifications apply:

- ❖ RFC 3036: LDP Specification
- ❖ RFC 3037: LDP Applicability
- ❖ RFC 3215: LDP State Machine
- ❖ RFC 3478: Graceful Restart Mechanism for Label Distribution Protocol
- ❖ RFC 3479: Fault Tolerance for the Label Distribution Protocol (LDP)

4.3.2 Configuration

Network Environment

It is necessary to configure VPWS GR for VPWS applications on service bearing devices on an MPLS network, so that data forwarding is not interrupted during master/slave management board switchover on devices, thus guaranteeing traffic continuity.



Note The GR capability does not guarantee traffic continuity when master/slave management board switchover also occurs on neighboring devices.

Prerequisites

Complete the following tasks before configuring VPWS GR:

- ❖ Build a VPWS environment and configure VPWS.
- ❖ Ensure that the IGP has GR capability.
- ❖ Ensure that the LDP has GR capability.



Note For details about VPWS configuration, see the section "Configuring VPWS" in *MPLS*.

Data Preparations

Prepare the following data before configuring VPWS GR:

- ❖ IGP GR parameters

- ❖ LDP GR parameters

4.3.2.1 Configuring IGP GR



Note For details about IGP GR configuration, see related sections in *OSPF*.

4.3.2.2 Configuring LDP GR



Note For details about LDP GR configuration, see section 1.1 "LDP GR" in this document.

4.3.2.3 Verification

To display **VPWS** GR configuration and running information, run the following commands:

Command	Function
<code>show mpls ldp graceful-restart [all vrf vrf-name]</code>	Shows LDP GR sessions and session parameters
<code>show mpls ldp vc [all vpws hub spoke] [vc-id]</code>	Shows LDP Pseudo Wire (PW) information



Note All the preceding commands can be configured in any mode except for the user mode.

4.3.3 Configuration Example

Networking Requirements

- ❖ Interconnection ports between PE and CE devices work in access mode, so that each CE device is connected to the respective PE device through an access link. The respective PE device establishes PW services for the Virtual Local Area Network (VLAN) to which the access port belongs. Since the Ethernet mode is applied, frames transmitted on the PW between PE 1 and PE 2 do not carry the VLAN 10 tag.
- ❖ CE, PE, and P devices support the LDP and are capable of GR.
- ❖ PE and P devices support the LDP and are capable of GR.
- ❖ PE and P devices form a provider network.
- ❖ PE devices are GR-capable routers, and the P device is a GR-aware router.

Topology

Figure 1-6 Network Topology for Configuring L2VPN GR

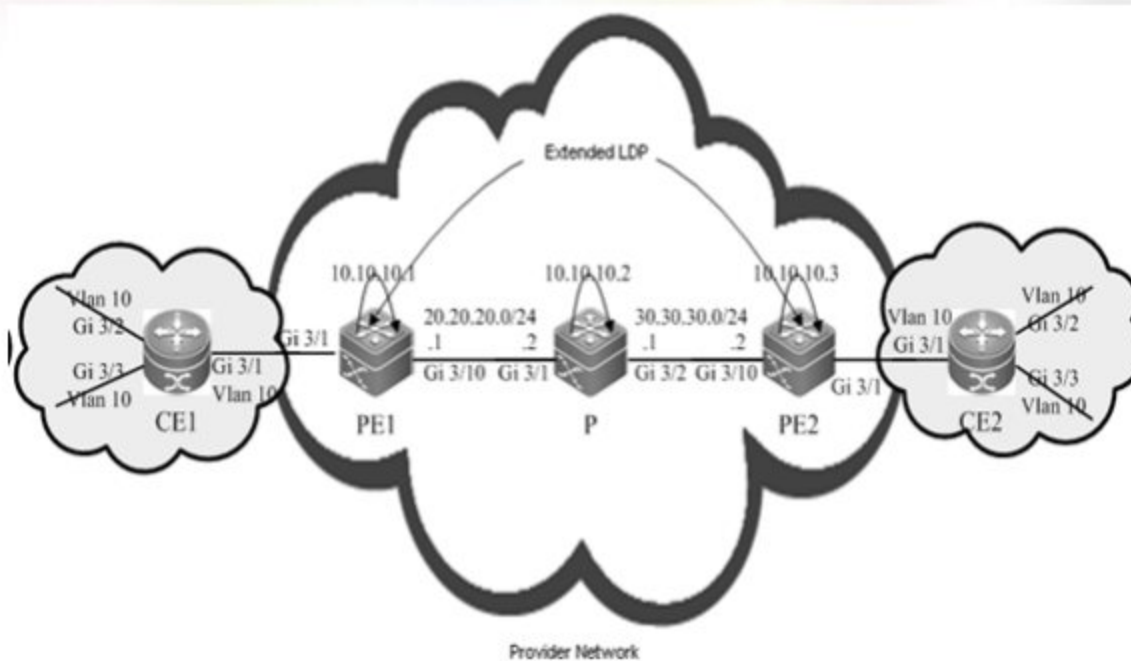

Notes

Configure PE 1, PE 2, and the P device as follows:

- ❖ Configure interface IP addresses and the OSPF protocol.
- ❖ Enable global MPLS forwarding on devices, and MPLS packet forwarding and the LDP on interfaces.
- ❖ Configure the LDP so that the network can forward MPLS traffic.
- ❖ Configure VPWS.
- ❖ Enable the LDP GR protocol, and configure parameters related to LDP GR.
- ❖ Restart the LDP session for the configurations to take effect.

Configuration Steps

- ❖ Configure interface IP addresses and the OSPF protocol.

Configure PE 1.

```
Qtech#configure terminal
Enter configuration commands, one per line. End with CNTL/Z.
```

The **no switchport** command is run on a switch to change to the Routed Port mode and not applicable to routers. Therefore, it does not need to be run on a router.

```
Qtech(config)#interface gigabitEthernet 3/10
Qtech(config-if-GigabitEthernet 3/10)#no switchport
Qtech(config-if-GigabitEthernet 3/10)#ip address 20.20.20.1 255.255.255.0
Qtech(config-if-GigabitEthernet 3/10)#exit
```

```
Qtech(config)#interface loopback 0
Qtech(config Loopback 0)#ip address 10.10.10.1 255.255.255.255
Qtech(config Loopback 0)#exit
```

Activate the OSPF protocol and enter the OSPF mode.

```
Qtech(config)#router ospf 10
Qtech(config router)#network 20.20.20.0 255.255.255.0 area 0
Qtech(config router)#network 10.10.10.1 255.255.255.255 area 0
Qtech(config router)#end
```

Configure the P device.

```
Qtech#configure terminal
Enter configuration commands, one per line. End with CNTL/Z.
```

The **no switchport** command is run on a switch to change to the Routed Port mode and not applicable to routers. Therefore, it does not need to be run on a router.

```
Qtech(config)#interface gigabitEthernet 3/1
Qtech(config if GigabitEthernet 3/1)#no switchport
Qtech(config if GigabitEthernet 3/1)#ip address 20.20.20.2 255.255.255.0
Qtech(config if GigabitEthernet 3/1)#exit
```

The **no switchport** command is run on a switch to change to the Routed Port mode and not applicable to routers. Therefore, it does not need to be run on a router.

```
Qtech(config)#interface gigabitEthernet 3/2
Qtech(config if GigabitEthernet 3/2)#no switchport
Qtech(config if GigabitEthernet 3/2)#ip address 30.30.30.1 255.255.255.0
Qtech(config if GigabitEthernet 3/2)#exit
```

Configure a loopback interface named **loopback 0**.

```
Qtech(config)#interface loopback 0
Qtech(config Loopback 0)#ip address 10.10.10.1 255.255.255.255
Qtech(config Loopback 0)#exit
```

Activate the OSPF protocol and enter the OSPF mode.

```
Qtech(config)#router ospf 10
Qtech(config router)#network 20.20.20.0 255.255.255.0 area 0
Qtech(config router)#network 30.30.30.0 255.255.255.0 area 0
Qtech(config router)#network 10.10.10.2 255.255.255.255 area 0
Qtech(config router)#end
```

Configure PE 2.

```
Qtech#configure terminal
Enter configuration commands, one per line. End with CNTL/Z.
```

The `no switchport` command is run on a switch to change to the Routed Port mode and not applicable to routers. Therefore, it does not need to be run on a router.

```
Qtech(config)#interface gigabitEthernet 3/10
Qtech(config if GigabitEthernet 3/10)#no switchport
Qtech(config if GigabitEthernet 3/10)#ip address 30.30.30.2 255.255.255.0
Qtech(config if GigabitEthernet 3/10)#exit
```

Configure a loopback interface named `loopback 0`.

```
Qtech(config)#interface loopback 0
Qtech(config Loopback 0)#ip address 10.10.10.3 255.255.255.255
Qtech(config Loopback 0)#exit
```

Activate the OSPF protocol and enter the OSPF mode.

```
Qtech(config)#router ospf 10
Qtech(config router)#network 30.30.30.0 255.255.255.0 area 0
Qtech(config router)#network 10.10.10.3 255.255.255.255 area 0
Qtech(config router)#end
```

❖ Enable global MPLS forwarding on devices, and MPLS packet forwarding and the LDP on interfaces.

Configure PE 1.

```
Qtech#configure terminal
Enter configuration commands, one per line. End with CNTL/Z.
Qtech(config)#mpls ip
```

The `ip ref` command is run a router to enable MPLS fast forwarding on the router. It does not need to be run on a switch.

```
Qtech(config)#interface gigabitEthernet 3/10
Qtech(config if GigabitEthernet 3/10)#label switching
Qtech(config if GigabitEthernet 3/10)#mpls ip
Qtech(config if GigabitEthernet 3/10)#ip ref
Router(config if GigabitEthernet 3/10)#exit
```

Configure the P device.

```
Qtech#configure terminal
Enter configuration commands, one per line. End with CNTL/Z.
Qtech(config)#mpls ip
```

The `ip ref` command is run a router to enable MPLS fast forwarding on the router. It does not need to be run on a switch.

```
Qtech(config)#interface gigabitEthernet 3/1
Qtech(config if GigabitEthernet 3/1)#label switching
Qtech(config if GigabitEthernet 3/1)#mpls ip
```



```
Qtech(config if GigabitEthernet 3/1)#ip ref
Router(config if GigabitEthernet 3/1)#exit
```

The ip ref command is run a router to enable MPLS fast forwarding on the router. It does not need to be run on a switch.

```
Qtech(config)#interface gigabitEthernet 3/2
Qtech(config if GigabitEthernet 3/2)#label switching
Qtech(config if GigabitEthernet 3/2)#mpls ip
Qtech(config if GigabitEthernet 3/2)#ip ref
Router(config if GigabitEthernet 3/2)#exit
```

Configure PE 2 by running the same commands as those on PE 1.

❖ **Configure the LDP so that the network can forward MPLS traffic.**

Configure PE 1.

```
Qtech#configure terminal
Enter configuration commands, one per line. End with CNTL/Z.
Qtech(config)#mpls router ldp
Qtech(config mpls router)#ldp router id interface loopback 0 force
```

Configure a remote LDP neighbor.

```
Qtech(config mpls router)#neighbor 10.10.10.3
Qtech(config mpls router)#exit
```

Configure the P device.

```
Qtech#configure terminal
Enter configuration commands, one per line. End with CNTL/Z.
Qtech(config)#mpls router ldp
Qtech(config mpls router)#ldp router id interface loopback 0 force
```

Configure PE 2.

```
Qtech#configure terminal
Enter configuration commands, one per line. End with CNTL/Z.
Qtech(config)#mpls router ldp
Qtech(config mpls router)#ldp router id interface loopback 0 force
```

Configure a remote LDP neighbor.

```
Qtech(config mpls router)#neighbor 10.10.10.1
Qtech(config mpls router)#exit
```

❖ **Configure VPWS.**

Configure PE 1.

```
Qtech#configure terminal
```

Enter configuration commands, one per line. End with CNTL/Z.

Switch configurations

Configure access ports between PE 1 and CE 1.

```
Qtech(config)#interface gigabitEthernet 3/1
Qtech(config if GigabitEthernet 3/1)#switchport mode access
Qtech(config if GigabitEthernet 3/1)#switchport access vlan 10
Qtech(config if GigabitEthernet 3/1)#exit
```

Configure PW services for VLAN 10 on PE 1.

```
Qtech(config)#interface vlan 10
Qtech(config if VLAN 10)#xconnect 10.10.10.3 2 encapsulation mpls ethernet
Qtech(config if VLAN 10)#exit
```

Router configurations

Configure PW services for the GE interface 3/1 on PE 1.

```
Qtech(config)#interface gigabitEthernet 3/1
Qtech(config if GigabitEthernet 3/1)#ip ref
Qtech(config if GigabitEthernet 3/1)#xconnect 10.10.10.3 2 encapsulation mpls ethernet
Qtech(config if GigabitEthernet 3/1)#exit
```

Configure PE 2.

```
Qtech#configure terminal
Enter configuration commands, one per line. End with CNTL/Z.
```

Switch configurations

Configure access ports between PE 2 and CE 2.

```
Qtech(config)#interface gigabitEthernet 3/1
Qtech(config if GigabitEthernet 3/1)#switchport mode access
Qtech(config if GigabitEthernet 3/1)#switchport access vlan 10
Qtech(config if GigabitEthernet 3/1)#exit
```

Configure PW services for VLAN 10 on PE 2.

```
Qtech(config if VLAN 10)#interface vlan 10
Qtech(config if VLAN 10)#xconnect 10.10.10.1 2 encapsulation mpls ethernet
Qtech(config if VLAN 10)#exit
```

Router configurations

Configure PW services for the GE interface 3/1 on PE 2.

```
Qtech(config)#interface gigabitEthernet 3/1
Qtech(config if GigabitEthernet 3/1)#ip ref
Qtech(config if GigabitEthernet 3/1)#xconnect 10.10.10.1 2 encapsulation mpls ethernet
```

```
Qtech(config if GigabitEthernet 3/1)#exit
```

❖ Enable the LDP GR protocol, and configure parameters related to LDP GR.

Configure PE 1.

```
Qtech#configure terminal
Enter configuration commands, one per line. End with CNTL/Z.
Qtech(config)#mpls router ldp
Qtech(config mpls router)#graceful restart
```

Set the LDP reconnection time to 300 seconds, LDP neighbor keep-alive time to 120 seconds, and LDP recovery time to 120 seconds.

```
Qtech(config mpls router)#graceful restart timer reconnect 300
Qtech(config mpls router)#graceful restart timer neighbor liveness 120
Qtech(config mpls router)#graceful restart timer recovery 120
Qtech(config mpls router)#exit
```

Configure the P device.

```
Qtech#configure terminal
Enter configuration commands, one per line. End with CNTL/Z.
Qtech(config)#mpls router ldp
Qtech(config mpls router)#graceful restart
```

Set the LDP reconnection time to 300 seconds, LDP neighbor keep-alive time to 120 seconds, and LDP recovery time to 120 seconds.

```
Qtech(config mpls router)#graceful restart timer reconnect 300
Qtech(config mpls router)#graceful restart timer neighbor liveness 120
Qtech(config mpls router)#graceful restart timer recovery 120
Qtech(config mpls router)#exit
```

Configure PE 2 by running the same commands as those on PE 1.

❖ Restart the LDP session for the configurations to take effect.

Restart the LDP session on PE 1.

```
Qtech#clear mpls ldp neighbor all
```

Restart the LDP session on the PE device.

```
Qtech#clear mpls ldp neighbor all
```

Restart the LDP session on PE 1.

```
Qtech#clear mpls ldp neighbor all
```

Verification

Run the following commands to show configurations on PE 1:

Show LDP GR information on PE 1.

```
Qtech#show mpls ldp graceful restart
Default VRF:
  LDP Graceful Restart is enabled
  Neighbor Liveness Timer: 120 seconds
  Max Recovery Time: 120 seconds
  Forwarding State Holding Time: 300 seconds
  Down Neighbor Database (1 records):
    Peer LDP Ident: 10.10.10.2:0; Local LDP Ident: 10.10.10.1:0
      Status: recovering (86 seconds left)
      Address list contains 3 addresses:
        10.10.10.2   20.20.20.2   30.30.30.1
  Graceful Restart enabled Sessions:
Peer LDP Ident: 10.10.10.2:0, State: estab
```

4.4 MPLS BFD



Note The routers or router icons involved in this chapter represent common routers or L3 switches where routing protocols are running.

4.4.1 Overview



Note MPLS Bidirectional Forwarding Detection (BFD) is implemented in accordance with *BFD For MPLS LSPs* as defined by IETF. As a component of BFD applications, MPLS BFD describes a method for detecting MPLS LSPs. For details about BFD, see related sections in *BFD*.

In general, the following methods are used to detect LSP faults on an MPLS network:

- ❖ MPLS OAM mechanism. It can effectively detect, confirm, and locate internal defects or faults on an MPLS network. Currently, however, the standardization for MPLS OAM is still under way and various OAM mechanisms are in a starting-off phase in terms of practical network applications. Therefore, not all devices on a network are able to support OAM.
- ❖ Hello packet mechanism of the MPLS signaling protocol. It takes a long time for the mechanism to detect a fault. In general, the detection time is a matter of seconds. Therefore, plenty of traffic will be lost if the hello mechanism is applied.

MPLS BFD can resolve all the preceding problems. It has the following features:

- ❖ MPLS BFD supports interworking and provides a unified detection mechanism for the entire network.
- ❖ MPLS BFD provides fast detection. It makes possible lightly-loaded fast detection to quicken the start of a backup forwarding path and therefore improves MPLS network reliability.
- ❖ MPLS BFD can be used to detect MPLS LSP faults on the data plane. BFD uses a fixed packet format which facilitates hardware implementation and firewall transversal.

4.4.1.1 EFD Session Establishment

BFD uses a local discriminator known as My Discriminator and a remote discriminator known as Your Discriminator to differentiate BFD sessions between a pair of systems. The discriminators can be configured in either manual or auto mode.

- ❖ Manual configuration: The local discriminator and the remote discriminator are manually configured for BFD, so that the LSP Ping Echo packet to be sent before BFD session establishment does not need to carry any discriminator to perform negotiation and learn the remote discriminator. Instead, a BFD session is directly established.
- ❖ Auto configuration: The LSP Ping Echo packet to be sent before BFD session establishment carries a discriminator to perform negotiation and learn the remote discriminator before a BFD session is established.

At the initial stage of BFD session establishment, the roles of devices at both ends are classified into initiators and passive LSRs. Whether the ingress/egress LSR is an initiator or a passive LSR depends on specific applications, but at least one of them must be the initiator. Therefore, the following two scenarios may exist at the initial stage:

Both Are Initiators

If both the ingress LSR and the egress LSR are initiators, LSPs are unidirectional. Therefore, this scenario can be further divided into the following two cases:

- ❖ BFD is applied to detect both LSPs from the ingress LSR to the egress LSR and from the egress LSR to the ingress LSR

The ingress LSR sends an LSP Ping echo request that carries a local discriminator to the egress LSR. When the egress LSR receives the echo request, it obtains a remote discriminator from the echo request, so that the egress LSR owns both a local discriminator generated by itself and a remote discriminator. Then the egress LSR sends a BFD control packet to the ingress LSR. When the ingress LSR receives the BFD control packet, it obtains a remote discriminator from the received BFD control packet. Therefore, the ingress LSR also owns a local discriminator generated by itself and a remote discriminator, and then sends a BFD control packet to the egress LSR. Till now, both LSRs proceed to the initial stage of BFD session establishment.

It should be specially noted that the egress LSR may return or not return an echo reply upon receipt of the echo request. If the egress LSR returns an echo reply, the echo reply must carry a

local discriminator generated by the egress LSR itself, so that the ingress LSR can obtain a remote discriminator from either the BFD control packet or the echo reply.



Note

The working process on the egress LSR is similar to that on the ingress LSR.

- ❖ BFD is applied to detect the LSP from the ingress LSR to the egress LSR, and detect IP addresses (in a multi-hop situation) from the egress LSR to the ingress LSR

In this case, discriminators are manually configured on the ingress LSR and the egress LSR to establish a BFD session. In other words, the BFD session is established without experiencing automatic discriminator negotiation but the session establishment process directly starts after discriminators are manually configured on the two LSRs.

One Is the Initiator and the Other Is a Passive LSR

The initiator sends an LSP Ping echo request that carries a local discriminator to the passive LSR. When the passive LSR receives the echo request, it obtains a remote discriminator from the echo request, so that it owns both a local discriminator generated by itself and a remote discriminator. Then the passive LSR sends a BFD control packet to the initiator. When the initiator receives the BFD control packet, it obtains a remote discriminator from the received BFD control packet. Therefore, the initiator also owns a local discriminator generated by itself and a remote discriminator, and then sends a BFD control packet to the passive LSR. Till now, both LSRs proceed to the initial stage of BFD session establishment.

It should be specially noted that the passive LSR may return or not return an echo reply upon receipt of the echo request. If the passive LSR returns an echo reply, the echo reply must carry a local discriminator generated by the passive LSR itself, so that the initiator can obtain a remote discriminator from either the BFD control packet or the echo reply.

The passive LSR will not send any BFD control packet to the initiator unless it has received the echo request from the initiator.



Note

Currently, only the first case is supported for BFD+LSP. That is, both LSRs must be initiators.

Example

This section describes the BFD session establishment process when both LSRs are initiators and BFD is applied to detect both LSPs from the ingress LSR to the egress LSR and from the egress LSR to the ingress LSR.

Figure 2-1 BFD Session Establishment Process

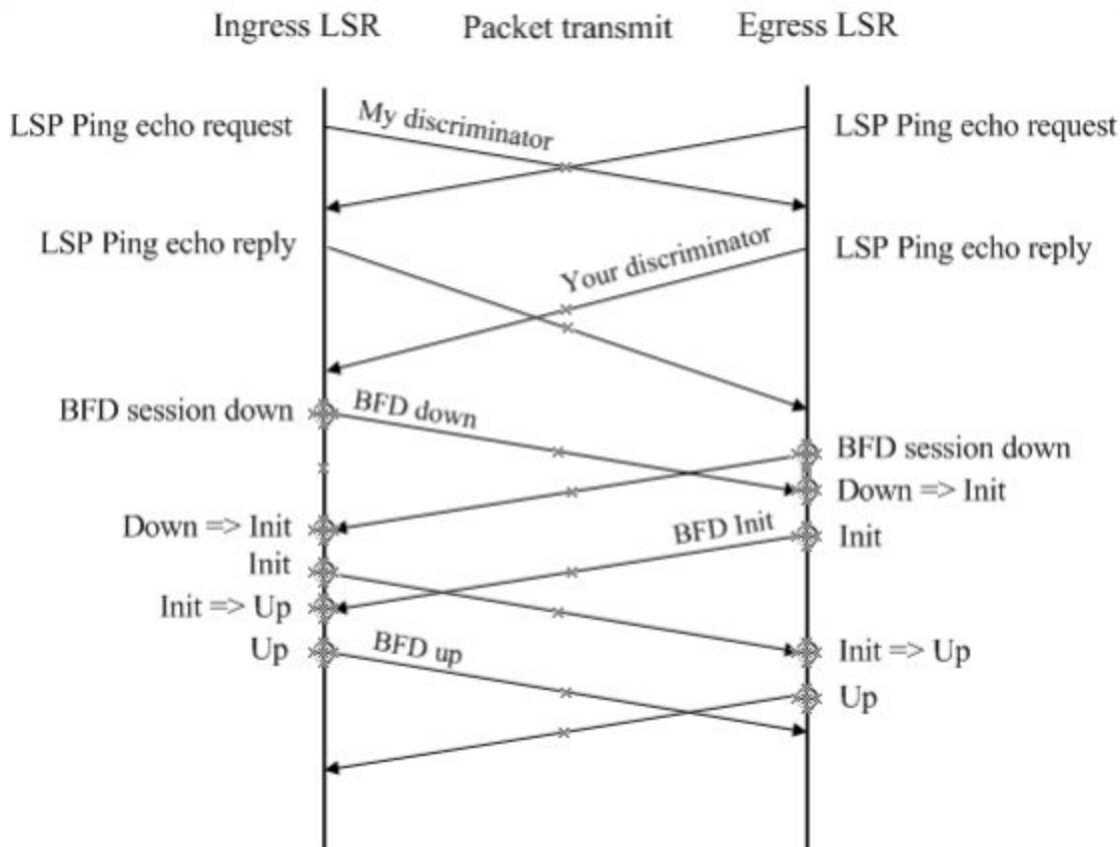

Before the

ingress LSR and the egress LSR start BFD, they must learn the remote discriminator from each other and ensure that the LSPs are up. As shown in Figure 2-1, the ingress LSR sends an LSP Ping echo request that carries a local discriminator to the egress LSR. Upon receipt of the echo request, the egress LSR returns an echo reply that carries the local discriminator generated by the egress LSR itself to the ingress LSR. This is the same for the egress LSR. It should be specially noted that an LSR needs to learn the remote discriminator from the LSP Ping echo request if discriminators are not manually specified on both LSRs. If both the local discriminator and the remote discriminator are specified on both LSRs, this step does not apply during BFD session establishment but the next step directly continues. For details about discriminator configuration, see section 2.1.3 "BFD+LSP".

- ❖ The ingress LSR and the egress LSR start the BFD mechanism. The initial BFD status is Down on both LSRs. Each LSR sends a BFD packet that carries the "Down" status.
- ❖ Upon receipt of the BFD packet that carries the "Down" status, the egress LSR transits its local BFD status to "Init" and sends a BFD packet that carries the "Init" status.
- ❖ Subsequently the egress LSR no longer processes any received BFD packet that carries the "Down" status after its local BFD status changes to "Init".
- ❖ The same BFD status transition process applies on the ingress LSR.
- ❖ When receiving a BFD packet that carries the "Init" state, the egress LSR changes its local BFD status to "Up".

- ❖ The same BFD status transition process applies on the ingress LSR.
- ❖ The status of the local BFD session status is "Up", indicating that a BFD session has been successfully established.

4.4.1.2 BFD Modes

Before two LSRs exchange BFD control packets, a BFD session must be established on the condition that the control plane and the data plane take the same path. The following two modes exist for BFD session operations:

- ❖ Asynchronous mode
- ❖ Inquiry mode

In addition to the two operation modes, an echo function is also defined for BFD. The echo function can be applied to both the asynchronous mode and the inquiry mode.



Note Currently, only the asynchronous mode is supported for BFD+LSP. The inquiry mode and the echo function are not yet supported in the BFD+LSP scenario.

4.4.1.3 BFD+LSP

A BFD session is identified by a local discriminator known as My Discriminator and a remote discriminator known as Your Discriminator. The following two configuration modes can be applied to BFD+LSP depending on the way by which the local discriminator and the remote discriminator are specified:

- ❖ Manual configuration
- ❖ In manual configuration mode, The local discriminator and the remote discriminator are manually configured for BFD, so that the LSP Ping Echo packet to be sent before BFD session establishment does not need to carry any discriminator to perform negotiation and learn the remote discriminator. Instead, a BFD session is directly established.
- ❖ Auto configuration
- ❖ In auto configuration mode, the LSP Ping Echo packet to be sent before BFD session establishment carries a discriminator to perform negotiation and learn the remote discriminator before a BFD session is established.

Currently BFD+LSP is classified by LSP type into BFD for static LSPs and BFD for LDP LSPs.

BFD for Static LSPs

BFD for static LSPs can be configured in either manual or auto mode. Since LSPs are unidirectional links but BFD is a bidirectional mechanism, reverse link detection can be performed based on one of the following detection methods when BFD is used to detect static LSPs:

- ❖ IP address mode for reverse link detection
- ❖ Static LSP mode for reverse link detection

BFD for LDP LSPs

BFD for static LSPs can be configured in either manual or auto mode. Since LSPs are unidirectional links but BFD is a bidirectional mechanism, reverse link detection can be performed based on one of the following detection methods when BFD is used to detect LDP LSPs:

- ❖ IP address mode for reverse link detection
- ❖ LDP LSP mode for reverse link detection

LDP LSPs bear basic VPN/PW public network services, so BFD for LDP LSPs is a mechanism for detecting faults of basic VPN/PW public network services. It provides fast detection for MPLS-based applications, such as VPN FRR and PW FRR, so as to protect services and guarantee MPLS network reliability.

4.4.1.4 Default Settings

Feature	Default
BFD session establishment mode	Active mode. Both LSRs must be initiators during BFD+LSP applications.
BFD mode	Asynchronous mode. Currently, only the asynchronous mode is supported for BFD+LSP. The inquiry mode and the echo function are not yet supported in the BFD+LSP scenario.
BFD session parameters	No default values are available. The BFD session parameters must be manually configured.
BFD authentication mode	Disabled. BFD authentication is not supported.

4.4.1.5 Protocols and Standards

The following protocols or specifications apply:

- ❖ draft-ietf-bfd-base-09: Bidirectional Forwarding Detection
- ❖ draft-ietf-bfd-generic-05: Generic Application of BFD
- ❖ draft-ietf-bfd-mib-06: Bidirectional Forwarding Detection Management Information Base
- ❖ draft-ietf-bfd-v4v6-1hop-09: BFD for IPv4 and IPv6 (Single Hop)
- ❖ draft-ietf-bfd-multihop-07: BFD for IPv4 and IPv6 (Multihop)
- ❖ draft-ietf-bfd-mpls-07: BFD For MPLS LSPs

4.4.2 Configuration

4.4.2.1 Configuring BFD for Static LSPs

Network Environment

BFD can be used to detect the continuity of static LSPs. When BFD is used for static LSPs, a static LSP that is down will not be selected as the forwarding path of a private network route.

Prerequisites

Complete the following tasks before configuring BFD for static LSPs:

- ❖ Enable MPLS.
- ❖ Configure static LSPs.

Data Preparations

Prepare the following data before configuring BFD for static LSPs:

- ❖ My Discriminator and Your Discriminator of the BFD session
- ❖ Selection of the reverse link detection method
- ❖ BFD session parameters: BFD control packet sending interval, BFD control packet receiving interval, and the detection multiplier of BFD control packets

4.4.2.2 Configuring BFD on the Ingress LSR

By default, BFD for static LSPs is disabled on a device. To enable BFD for static LSPs on a device, enter the privileged user mode and then run the following commands in turn:

Command	Function
Qtech# configure terminal	Enters the global configuration mode
Qtech(config)# interface type ID	Enters the interface configuration mode
Qtech(config-if-type ID)# bfd interval <i>milliseconds</i> min_rx <i>milliseconds</i> multiplier <i>multiplier-value</i>	Sets BFD session parameters
Qtech(config-if-type ID)# exit	Exits the interface configuration mode
Qtech(config)# bfd bind static-lsp peer-ip <i>ip-address</i> source-ip <i>ip-address</i> [local-discriminator <i>discr-value</i> remote-discriminator <i>discr-value</i>] [process-state]	Sets BFD for static LSPs along with BFD session status handling If manual configuration is applied on the ingress LSR, manual configuration must also be applied on the egress LSR. In other words, the configuration modes on both LSRs must be symmetrical.

To disable BFD for static LSPs, run the **no bfd bind static-lsp peer-ip ip-address** command.



Caution

Only static LSPs established by host route triggering are supported in BFD for static LSPs.

The *process-state* parameter must be specified for applications using BFD for fault detection, for example, when BFD is combined with LSP.

**Caution**

If discriminators are manually configured, the local and remote discriminators configured on the ingress LSR must match with those configured on the egress LSR.

4.4.2.3 Configuring BFD on the Egress LSR

By default, BFD for static LSPs is disabled on a device. To enable BFD for static LSPs on a device, enter the privileged user mode and then run the following commands in turn:

Command	Function
Qtech# configure terminal	Enters the global configuration mode
Qtech(config)# interface type ID	Enters the interface configuration mode
Qtech(config-if-type ID)# bfd interval milliseconds min_rx milliseconds multiplier multiplier-value	Sets BFD session parameters
Qtech(config-if-type ID)# exit	Exits the interface configuration mode
Qtech(config)# bfd bind static-lsp peer-ip ip-address source-ip ip-address [local-discriminator discr-value remote-discriminator discr-value] [process-state]	Sets BFD for static LSPs without BFD session status handling If manual configuration is applied on the ingress LSR, manual configuration must also be applied on the egress LSR. In other words, the configuration modes on both LSRs must be symmetrical.
Or:	
bfd bind backward-lsp-with-ip peer-ip ip-address [vrf vrf-name] interface interface-type interface-number [source-ip ip-address] { local-discriminator discr-value remote-discriminator discr-value }	Sets the IP address mode for reverse link detection in BFD for LSPs If the IP mode is applied for LSP reverse link detection during configuration, a local discriminator and a remote discriminator must be manually specified for the forward LSP.
Qtech(config)# exit	Exits the global configuration mode

To disable BFD for static LSPs, run the `no bfd bind static-lsp peer-ip ip-address` or `no bfd bind backward-lsp-with-ip peer-ip ip-address [vrf vrf-name]` command.

**Caution**

Only static LSPs established by host route triggering are supported in BFD for static LSPs.

The IP detection mode can be applied on the reverse link during BFD for LSPs.

If discriminators are manually configured, the local and remote discriminators configured on the egress LSR must match with those configured on the ingress LSR.

4.4.2.4 Verification

To display configuration and running information about BFD for static LSPs, run the following commands:

Command	Function
<code>show bfd neighbors [vrf vrf-name] [ipv4 ip-address [details]] client { static-lsp backward-lsp-with-ip } [ipv4 ip-address [details]] [details]]</code>	Shows BFD session information

4.4.2.5 Configuring BFD for LDP LSPs

Network Environment

BFD can be used to detect the continuity of LDP LSPs. When BFD is used with LDP LSPs, an LDP LSP that is down will not be selected as the forwarding path of a private network route.

Prerequisites

Complete the following tasks before configuring BFD for LDP LSPs:

- ❖ Enable MPLS.
- ❖ Enable LDP.

Data Preparations

Prepare the following data before configuring BFD for LDP LSPs:

- ❖ My Discriminator and Your Discriminator of the BFD session
- ❖ Selection of the reverse link detection method
- ❖ BFD session parameters: BFD control packet sending interval, BFD control packet receiving interval, and the detection multiplier of BFD control packets

4.4.2.6 Configuring BFD on the Ingress LSR

By default, BFD for LDP LSPs is disabled on a device. To enable BFD for LDP LSPs on a device, enter the global configuration mode and then run the following commands in turn:

Command	Function
<code>Qtech# configure terminal</code>	Enters the global configuration mode
<code>Qtech(config)# interface type ID</code>	Enters the interface configuration mode
<code>Qtech(config-if-type ID)# bfd interval milliseconds min_rx milliseconds multiplier multiplier-value</code>	Sets BFD session parameters
<code>Qtech(config-if-type ID)# exit</code>	Exits the interface configuration mode
<code>Qtech(config)#mpls router ldp</code>	Enters the LDP configuration mode
<code>Qtech(config)# bfd bind ldp-lsppeer-ip ip-address [vrf vrf-name] nexthop ip-address [interface interface-type interface-number] source-ip ip-address [local-discriminator discr-value remote-discriminator discr-value] [process-state]</code>	Sets BFD for LDP LSPs along with BFD session status handling If manual configuration is applied on the ingress LSR, manual configuration must also be applied on the egress LSR. In other words, the configuration modes on both LSRs must be symmetrical.

To disable BFD for LDP LSPs, run the **no bfd bind ldp-lsp peer-ip ip-address** command.



Caution Only LDP LSP established by host route triggering are supported in BFD for LDP LSPs.

One LSP can be bound to only one BFD session.

BFD binding can be performed only on the ingress LSR of the LDP LSP.

The *process-state* parameter must be specified for applications using BFD for fault detection, for example, when BFD is combined with LSP.

If discriminators are manually configured, the local and remote discriminators configured on the ingress LSR must match with those configured on the egress LSR.

4.4.2.7 Configuring BFD on the Egress LSR

By default, BFD for LDP LSPs is disabled on a device. To enable BFD for LDP LSPs on a device, enter the privileged user mode and then run the following commands in turn:

Command	Function
Qtech# configure terminal	Enters the global configuration mode
Qtech(config)# interface type ID	Enters the interface configuration mode
Qtech(config-if-type ID)# bfd interval milliseconds min_rx milliseconds multiplier multiplier-value	Sets BFD session parameters
Qtech(config-if-type ID)# exit	Exits the interface configuration mode
Qtech(config)# bfd bind backward-lsp-with-ip peer-ip ip-address [vrf vrf-name] interface interface-type interface-number [source-ip ip-address] local-discriminator discr-value remote-discriminator discr-value	Sets the IP address mode for reverse link detection in BFD for LSPs If the IP mode is applied for LSP reverse link detection during configuration, a local discriminator and a remote discriminator must be manually specified for the forward LSP.
Or:	
Qtech(config)# mpls router ldp	Enters the LDP configuration mode
Qtech(config)# bfd bind ldp-lsppeer-ipip-address [vrfvrf-name] nexthopip-address [interfaceinterface-type interface-number] source-ipip-address [local-discriminatordiscr-valueremote-discriminatordiscr-value] [process-state]	Sets BFD for LDP LSPs without BFD session status handling If manual configuration is applied on the ingress LSR, manual configuration must also be applied on the egress LSR. In other words, the configuration modes on both LSRs must be symmetrical.
Qtech(config-bfd-router)# exit	Exits the LDP configuration mode

To disable BFD for LDP LSPs, run the **no bfd bind backward-lsp-with-ip peer-ip ip-address [vrf vrf-name]** or **no bfd bind ldp-lsp peer-ip ip-address** command.



Caution

The IP detection mode can be applied on the reverse link during BFD for LSPs.

Or BFD can be configured to detect the other LSP.

1. Only LDP LSPs established by host route triggering are supported in BFD for LDP LSPs.

2. One LSP can be bound to only one BFD session.

3. BFD binding can be performed only on the ingress LSR of the LDP LSP.

If discriminators are manually configured, the local and remote discriminators configured on the egress LSR must match with those configured on the ingress LSR.

4.4.2.8 Configuring BGP and BGP-LSP Binding

Use this command to bind BFD to BGP LSP in global configuration mode. Use the **no** form of this command to restore the default setting.

Command	Function
<code>bfd bind bgp-lsp peer-ip ip-address source-ip ip-address [local-discriminator discr-value remote-discriminator discr-value]</code>	Binds BFD to BGP LSP

- ❖ This command is executed on the LSP egress node.
- ❖ With BFD enabled, you can create the BFD session after configuring BGP LSP.
- ❖ If BGP LSP is deleted, the BFD session bound with it is deleted as well but the BFD session configuration remains. Once BGP LSP is configured, the BFD session is created.
- ❖ The BFD session can be configured with local and remote identification. If the local identification is not configured, the system selects one automatically. If the reverse LSP is an IP link, the LSP must be configured with local and remote identification manually.
- ❖ Once the BFD session is created, the identification cannot be changed.
- ❖ The system checks the submitted BFD configuration which creates no session and attempts to create BFD sessions periodically.
- ❖ The number of BFD sessions is limited. If the number of submitted BFD sessions exceeds the maximum, log messages are produced.



Caution

This function applies to BGP LSP initiated by the host routing. One LSP can be configured with one BFD session.

The following example binds BFD with BGP LSP whose source IP address is 20.20.20.20 and destination IP address is 10.10.10.10.

```
Qtech#configure terminal
Enter configuration commands, one per line. End with CNTL/Z.
```

```

Qttech(config)#mpls ip
Qttech(config)#interface gigabitEthernet 0/2
Qttech(config if GigabitEthernet 0/2)#no switchport
Qttech(config if GigabitEthernet 0/2)#mpls ip
Qttech(config if GigabitEthernet 0/2)#label switching
Qttech(config if GigabitEthernet 0/2)#bfd interval 100 min_rx 100 multiplier 3
Qttech(config if GigabitEthernet 0/2)#exit
Qttech(config)#bfd bind bgp lsp peer ip 10.10.10.10 source ip 20.20.20.20

```

The following example binds BFD with BGP LSP whose source IP address is 20.20.20.20 and destination IP address is 10.10.10.10. The local identification is 1 and the remote 2.

```

Qttech#configure terminal
Enter configuration commands, one per line. End with CNTL/Z.
Qttech(config)#mpls ip
Qttech(config)#interface gigabitEthernet 0/2
Qttech(config if GigabitEthernet 0/2)#no switchport
Qttech(config if GigabitEthernet 0/2)#mpls ip
Qttech(config if GigabitEthernet 0/2)#label switching
Qttech(config if GigabitEthernet 0/2)#bfd interval 100 min_rx 100 multiplier 3
Qttech(config if GigabitEthernet 0/2)#exit
Qttech(config)#bfd bind bgp lsp peer ip 10.10.10.10 source ip 20.20.20.20

```

4.4.2.9 Verification

To display configuration and running information about BFD for LDP LSPs, run the following commands:

Command	Function
<pre> show bfd neighbors [vrf vrf-name] [ipv4 ip-address [details] client { ldp-lsp backward-lsp-with-ip } [ipv4 ip-address [details] [details]] </pre>	Displays BFD session information

4.4.3 Configuration Example

4.4.3.1 Configuring BFD for Static LSPs

Networking Requirements

BFD can be configured to detect the continuity of static LSPs. Two links exist between PE 1 and PE 2, as shown in Figure 2-2.

- ❖ PE 1, PE 2, P1, and P2 form an MPLS network.
- ❖ A static LSP (LSP 1) exists and spans PE 1, P1 and PE 2 in turn. BFD is configured to detect this static LSP.
- ❖ A static LSP (LSP 2) exists and spans PE 2, P2 and PE 1 in turn. BFD is configured to detect this static LSP and notify faults if any to PE 1. This static LSP is used on the reverse link.

If LSP 1 fails, PE 1 can quickly receive a fault notification and handle the fault accordingly (by deleting respective static MPLS routes).

Topology

Figure 2-2 Network Topology for Configuring BFD for Static LSPs

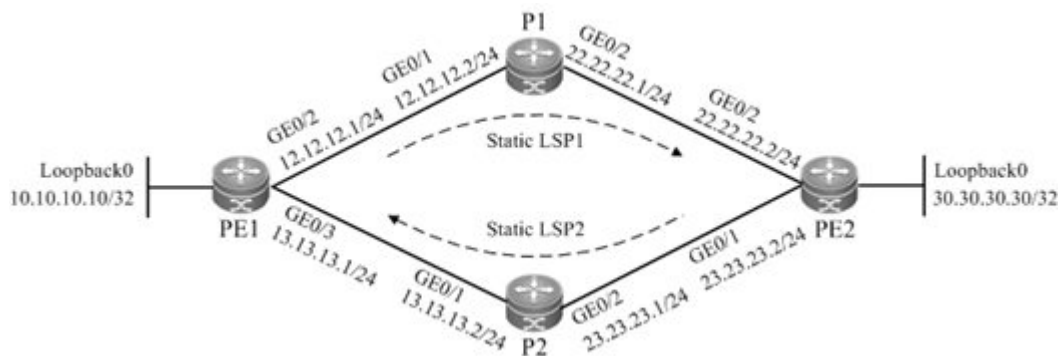

Notes

Configure all device as follows:

- ❖ Configure interface IP addresses and the OSPF protocol on devices.
- ❖ Enable global MPLS forwarding on all devices, and MPLS packet forwarding on interfaces.
- ❖ Configure static MPLS routes on the devices, so that the network can forward MPLS traffic.
- ❖ Configure BFD on PE 1 to detect LSP 1.
- ❖ Configure BFD on PE 2 to detect LSP 2, which is used as the LSP on the reverse link.

Configuration Steps

Configure interface IP addresses and the OSPF protocol on devices.

Configure PE 1.

```
Qtech#configure terminal
Enter configuration commands, one per line. End with CNTL/Z.
Qtech(config)#interface gigabitEthernet 0/2
Qtech(config if GigabitEthernet 0/2)#no switchport
Qtech(config if GigabitEthernet 0/2)#ip address 12.12.12.1 255.255.255.0
Qtech(config if GigabitEthernet 0/2)#exit
Qtech(config)#interface gigabitEthernet 0/3
Qtech(config if GigabitEthernet 0/3)#no switchport
Qtech(config if GigabitEthernet 0/3)#ip address 13.13.13.1 255.255.255.0
Qtech(config if GigabitEthernet 0/3)#exit
Qtech(config)#interface loopback 0
Qtech(config Loopback 0)#ip address 10.10.10.10 255.255.255.255
Qtech(config Loopback 0)#exit
Qtech(config)#router ospf 1
```



```
Router(config router)#network 12.12.12.1 255.255.255.0 area 0
Router(config router)#network 13.13.13.1 255.255.255.0 area 0
Router(config router)#network 10.10.10.10 255.255.255.255 area 0
Router(config router)#exit
```

Configure the other devices by running the same commands as those on PE 1.

Enable global MPLS forwarding on all devices, and MPLS packet forwarding on interfaces.

Configure PE 1.

```
Qtech#configure terminal
Enter configuration commands, one per line. End with CNTL/Z.
Qtech(config)#mpls ip
Qtech(config)#interface gigabitEthernet 0/2
Qtech(config if GigabitEthernet 0/2)#label switching
Qtech(config if GigabitEthernet 0/2)#mpls ip
Router(config if GigabitEthernet 0/2)#exit
Qtech(config)#interface gigabitEthernet 0/3
Qtech(config if GigabitEthernet 0/3)#label switching
Qtech(config if GigabitEthernet 0/3)#mpls ip
Router(config if GigabitEthernet 0/3)#exit
```

Configure the other devices by running the same commands as those on PE 1.

Configure static MPLS routes on the devices, so that the network can forward MPLS traffic.

Configure static LSP 1: PE1->P1->PE2.

Configure PE 1.

```
Qtech#configure terminal
Enter configuration commands, one per line. End with CNTL/Z.
Qtech(config)#mpls static ftn 30.30.30.30/32 out label 16 nexthop gigabitEthernet 0/2
12.12.12.2
```

Configure P1.

```
Qtech#configure terminal
Enter configuration commands, one per line. End with CNTL/Z.
Qtech(config)#mpls static ilm in label 16 forward action swap label 3 nexthop gigabitEthernet
0/2 22.22.22.2 fec 30.30.30.30/32
```

Run the **ping mpls ipv4 30.30.30.30** command on PE 1 after the preceding configurations are complete. Ensure that the ping operation is successful.

Configure static LSP 2: PE2->P2->PE1.

Configure PE 2.

```
Qtech#configure terminal
```

```
Enter configuration commands, one per line. End with CNTL/Z.
```

```
Qtech(config)#mpls static ftn 10.10.10.10/32 out label 16 nexthop gigabitEthernet 0/1  
23.23.23.1
```

Configure P2.

```
Qtech#configure terminal
```

```
Enter configuration commands, one per line. End with CNTL/Z.
```

```
Qtech(config)#mpls static ilm in label 16 forward action swap label 3 nexthop gigabitEthernet  
0/1 13.13.13.1 fec 10.10.10.10/32
```

Run the `ping mpls ipv4 10.10.10.10` command on PE 2 after the preceding configurations are complete. Ensure that the ping operation is successful.

Configure BFD on PE 1 to detect LSP 1.

```
Qtech#configure terminal
```

```
Enter configuration commands, one per line. End with CNTL/Z.
```

```
Qtech(config)#interface gigabitEthernet 0/2  
Qtech(config if GigabitEthernet 0/2)#bfd interval 50 min_rx 50 multiplier 3  
Qtech(config if GigabitEthernet 0/2)#exit  
Qtech(config)#bfd bind static lsp peer ip 30.30.30.30 source ip 10.10.10.10  
local discriminator 1 remote discriminator 2 process state  
Qtech(config)#exit
```

Configure BFD on PE 2 to detect LSP 2, which is used as the LSP on the reverse link.

```
Qtech#configure terminal
```

```
Enter configuration commands, one per line. End with CNTL/Z.
```

```
Qtech(config)#interface gigabitEthernet 0/1  
Qtech(config if GigabitEthernet 0/1)#bfd interval 50 min_rx 50 multiplier 3  
Qtech(config if GigabitEthernet 0/1)#exit  
Qtech(config)#bfd bind static lsp peer ip 10.10.10.10 source ip 30.30.30.30  
local discriminator 2 remote discriminator 1  
Qtech(config)#exit
```

Verification

Show BFD session establishment information.

Show BFD session establishment information on PE 1.

```
Qtech# show bfd neighbors details
```

```
OurAddr      NeighAddr      LD/RD  RH  Holdown(mult)  State  Int  
10.10.10.10  30.30.30.30    1/2    1   532 (3 )       Up     Ge2/1
```

```
Local Diag: 0, Demand mode: 0, Poll bit: 0
```

```
MinTxInt: 200000, MinRxInt: 200000, Multiplier: 3
```

```
Received MinRxInt: 50000, Received Multiplier: 3
```

```
Holdown (hits): 600(22), Hello (hits): 200(84453)
```

```
Rx Count: 49824, Rx Interval (ms) min/max/avg: 208/440/332
```

```
Tx Count: 84488, Tx Interval (ms) min/max/avg: 152/248/196
```

```
Registered protocols: static lsp
Uptime: 02:18:49
Last packet:   Version: 1           Diagnostic: 0
I Hear You bit: 1           Demand bit: 0
Poll bit: 0           Final bit: 0
Multiplier: 3           Length: 24
My Discr.: 2           Your Discr.: 1
Min tx interval: 50000   Min rx interval: 50000
Min Echo interval: 0
```

Show BFD session establishment information on PE 2.

```
Qtech# show bfd neighbors details
OurAddr      NeighAddr      LD/RD  RH  Holdown(mult)  State  Int
30.30.30.30  10.10.10.10    1/2    1   532 (3 )       Up     Ge2/1
Local Diag: 0, Demand mode: 0, Poll bit: 0
MinTxInt: 200000, MinRxInt: 200000, Multiplier: 3
Received MinRxInt: 50000, Received Multiplier: 3
Holdown (hits): 600(22), Hello (hits): 200(84453)
Rx Count: 49824, Rx Interval (ms) min/max/avg: 208/440/332
Tx Count: 84488, Tx Interval (ms) min/max/avg: 152/248/196
Registered protocols: static lsp
Uptime: 02:18:49
Last packet:   Version: 1           Diagnostic: 0
I Hear You bit: 1           Demand bit: 0
Poll bit: 0           Final bit: 0
Multiplier: 3           Length: 24
My Discr.: 2           Your Discr.: 1
Min tx interval: 50000   Min rx interval: 50000
Min Echo interval: 0
```

4.4.3.2 Configuring BFD for LDP LSPs

Networking Requirements

BFD can be configured to detect the continuity of LDP LSPs. Two links exist between PE 1 and PE 2, as shown in Figure 2-3.

- ❖ PE 1, PE 2, P1, and P2 form an MPLS network.
- ❖ Costs are configured for the interfaces on PE 1 and PE 2, so that two LSPs can be established between PE 1 and PE 2, as shown in Figure 2-3.
- ❖ An LDP LSP (LDP LSP 1) exists and spans PE 1, P1 and PE 2 in turn. BFD is configured to detect this LDP LSP.
- ❖ An LDP LSP (LDP LSP 2) exists and spans PE 2, P2 and PE 1 in turn. BFD is configured to detect this LDP LSP and notify faults if any to PE 1. This LDP LSP is used on the reverse link.

If LDP LSP 1 fails, PE 1 can quickly receive a fault notification and handle the fault accordingly (by deleting respective MPLS routes).

Topology

Figure 2-3 Network Topology for Configuring BFD for LDP LSPs

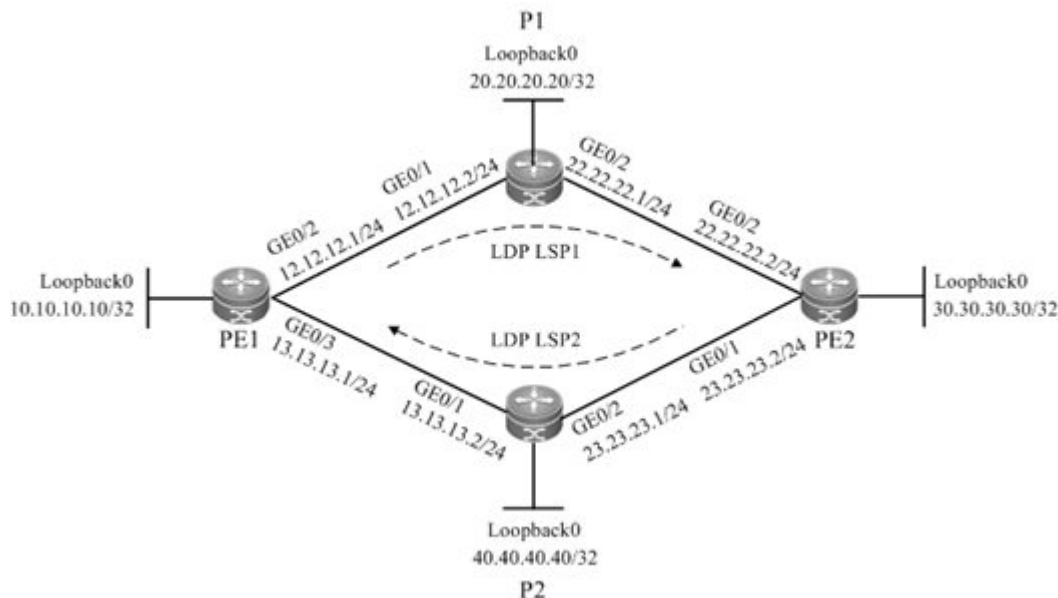

Notes

Configure all device as follows:

- ❖ Configure interface IP addresses and the OSPF protocol on devices.
- ❖ Enable global MPLS forwarding on devices, and MPLS packet forwarding and the LDP on interfaces.
- ❖ Configure the LDP so that the network can forward MPLS traffic.
- ❖ Configure BFD on PE 1 to detect LDP LSP 1.
- ❖ Configure BFD on PE 2 to detect LDP LSP 2, which is used as the LSP on the reverse link.

ConfigurationSteps

Configure interface IP addresses and the OSPF protocol on devices.

Configure PE 1.

```
Qtech#configure terminal
Enter configuration commands, one per line. End with CNTL/Z.
Qtech(config)#interface gigabitEthernet 0/2
Qtech(config-if GigabitEthernet 0/2)#no switchport
Qtech(config-if GigabitEthernet 0/2)#ip address 12.12.12.1 255.255.255.0
Qtech(config-if GigabitEthernet 0/2)#exit
Qtech(config)#interface gigabitEthernet 0/3
```

```
Qtech(config if GigabitEthernet 0/3)#no switchport
Qtech(config if GigabitEthernet 0/3)#ip address 13.13.13.1 255.255.255.0
Qtech(config if GigabitEthernet 0/3)#exit
Qtech(config)#interface loopback 0
Qtech(config Loopback 0)#ip address 10.10.10.10 255.255.255.255
Qtech(config Loopback 0)#exit
Qtech(config)#router ospf 1
Router(config router)#network 12.12.12.1 255.255.255.0 area 0
Router(config router)#network 13.13.13.1 255.255.255.0 area 0
Router(config router)#network 10.10.10.10 255.255.255.255 area 0
Router(config router)#exit
```

Configure the other devices by running the same commands as those on PE 1.

Enable global MPLS forwarding on devices, and MPLS packet forwarding and the LDP on interfaces.

Configure PE 1.

```
Qtech#configure terminal
Enter configuration commands, one per line. End with CNTL/Z.
Qtech(config)#mpls ip
Qtech(config)#interface gigabitEthernet 0/2
Qtech(config if GigabitEthernet 0/2)#label switching
Qtech(config if GigabitEthernet 0/2)#mpls ip
Router(config if GigabitEthernet 0/2)#exit
Qtech(config)#interface gigabitEthernet 0/3
Qtech(config if GigabitEthernet 0/3)#label switching
Qtech(config if GigabitEthernet 0/3)#mpls ip
Router(config if GigabitEthernet 0/3)#exit
```

Configure P1.

```
Qtech#configure terminal
Enter configuration commands, one per line. End with CNTL/Z.
Qtech(config)#mpls ip
Qtech(config)#interface gigabitEthernet 0/1
Qtech(config if GigabitEthernet 0/1)#label switching
Qtech(config if GigabitEthernet 0/1)#mpls ip
Router(config if GigabitEthernet 0/1)#exit
Qtech(config)#interface gigabitEthernet 0/2
Qtech(config if GigabitEthernet 0/2)#label switching
Qtech(config if GigabitEthernet 0/2)#mpls ip
Router(config if GigabitEthernet 0/2)#exit
```

Configure the other devices by running the same commands as those on PE 1.

Configure the LDP so that the network can forward MPLS traffic.

Configure PE 1.

```
Qtech#configure terminal
Enter configuration commands, one per line. End with CNTL/Z.
Qtech(config)#mpls router ldp
Qtech(config mpls router)#ldp router id interface loopback 0 force
```

Configure P1.

```
Qtech#configure terminal
Enter configuration commands, one per line. End with CNTL/Z.
Qtech(config)#mpls router ldp
Qtech(config mpls router)#ldp router id interface loopback 0 force
```

Configure the other devices by running the same commands as those on PE 1.

1. Configure BFD on PE 1 to detect LDP LSP 1.

```
Qtech#configure terminal
Enter configuration commands, one per line. End with CNTL/Z.
Qtech(config)#interface gigabitEthernet 0/2
Qtech(config if GigabitEthernet 0/2)#bfd interval 50 min_rx 50 multiplier 3
Qtech(config if GigabitEthernet 0/2)#exit
Qtech(config)#mpls router ldp
Qtech(config)#bfd bind ldp lsp peer ip 30.30.30.30 nexthop 12.12.12.2 interface
gigabitEthernet 0/2 source ip 10.10.10.10 local discriminator 1 remote discriminator 2
process state
Qtech(config)#exit
```

2. Configure BFD on PE 2 to detect LDP LSP 2, which is used as the LSP on the reverse link.

```
Qtech#configure terminal
Enter configuration commands, one per line. End with CNTL/Z.
Qtech(config)#interface gigabitEthernet 0/1
Qtech(config if GigabitEthernet 0/1)#bfd interval 50 min_rx 50 multiplier 3
Qtech(config if GigabitEthernet 0/1)#exit
Qtech(config)#mpls router ldp
Qtech(config)#bfd bind ldp lsp peer ip 10.10.10.10 nexthop 23.23.23.1 interface
gigabitEthernet 0/1 source ip 30.30.30.30 local discriminator 2 remote discriminator 1
Qtech(config)#exit
```

Verification

Show BFD session establishment information.

```
# Show BFD session establishment information on PE 1.
Qtech# show bfd neighbors details
OurAddr      NeighAddr    LD/RD  RH  Holdown(mult)  State  Int
10.10.10.10  30.30.30.30  1/2    1   532 (3 )       Up     Ge2/1
Local Diag: 0, Demand mode: 0, Poll bit: 0
MinTxInt: 200000, MinRxInt: 200000, Multiplier: 3
```

```
Received MinRxInt: 50000, Received Multiplier: 3
Holdown (hits): 600(22), Hello (hits): 200(84453)
Rx Count: 49824, Rx Interval (ms) min/max/avg: 208/440/332
Tx Count: 84488, Tx Interval (ms) min/max/avg: 152/248/196
Registered protocols: ldp lsp
Uptime: 02:18:49
Last packet:   Version: 1           Diagnostic: 0
I Hear You bit: 1       Demand bit: 0
Poll bit: 0           Final bit: 0
Multiplier: 3           Length: 24
My Discr.: 2           Your Discr.: 1
Min tx interval: 50000   Min rx interval: 50000
Min Echo interval: 0
```

Show BFD session establishment information on PE 2.

```
Qtech# show bfd neighbors details
OurAddr      NeighAddr      LD/RD  RH  Holdown(mult)  State  Int
30.30.30.30  10.10.10.10    1/2    1    532 (3 )       Up     Ge2/1
Local Diag: 0, Demand mode: 0, Poll bit: 0
MinTxInt: 200000, MinRxInt: 200000, Multiplier: 3
Received MinRxInt: 50000, Received Multiplier: 3
Holdown (hits): 600(22), Hello (hits): 200(84453)
Rx Count: 49824, Rx Interval (ms) min/max/avg: 208/440/332
Tx Count: 84488, Tx Interval (ms) min/max/avg: 152/248/196
Registered protocols: ldp lsp
Uptime: 02:18:49
Last packet:   Version: 1           Diagnostic: 0
I Hear You bit: 1       Demand bit: 0
Poll bit: 0           Final bit: 0
Multiplier: 3           Length: 24
My Discr.: 2           Your Discr.: 1
Min tx interval: 50000   Min rx interval: 50000
Min Echo interval: 0
```

4.5 LDP FRR



Note The routers or router icons involved in this chapter represent common routers or L3 switches where routing protocols are running.

4.5.1 Overview

LDP Fast Rerouting (FRR) ensures that traffic can switch over from a master LSP to a backup LSP within a very short time when the master LSP fails and that traffic switches back to a new LSP from the backup LSP during route convergence, so that traffic is not interrupted in the short time before network convergence, thus improving MPLS network reliability and protecting key services on the MPLS network.

Figure 3-1 Working Principles of LDP FRR

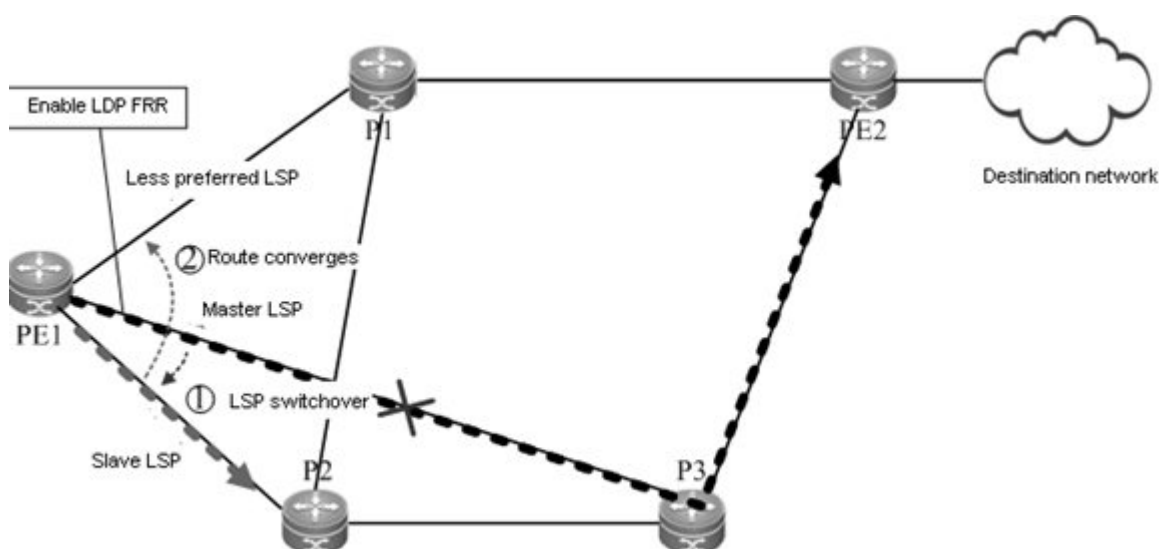

LDP FRR is an extension of the LDP. The LDP works in free label retention mode. LDP FRR backs up retained labels (i.e. LSPs). When a link fails, the system can quickly detect the failure of the master LSP using a fast link failure detection technology such as BFD. While the LDP regenerates a new LSP, traffic on the master LSP switches back to the backup LSP to implement uninterrupted traffic forwarding. After the new LSP is generated, traffic is forwarded on the new LSP.

As shown in Figure 3-1. LDP FRR involves three types of LSPs: master LSP, less preferred LSP, and backup LSP. The master LSP is the optimal LSP along which traffic is forwarded when the network is stable and routes are converged. The less preferred LSP is one that has a cost value larger than the cost value of the master LSP. When the master LSP fails, routes will converge on the less preferred LSP. The backup LSP is a backup LSP with a specified next hop. The three LSPs have different cost values.

In the LDP FRR solution, the next hop of the backup LSP interface is specified on the master LSP interface and BFD is configured on the master link to quickly detect faults of the master link. If the master link fails suddenly and a long time is required for routes to converge on the less preferred LSP, the quick link fault detection mechanism detects that the master link fails and therefore immediately switches traffic from the master LSP to the backup LSP, so that traffic is not discarded. In this way, traffic to the destination network is forwarded by the backup LSP before routes converge on the less preferred LSP.

In the following several seconds, the master link fault will be detected by the routing protocol and rerouting is performed through information exchange between routers. Finally, a notification message is sent to the LDP. The LDP regenerates a less preferred LSP according to the new next hop carried in the notification, and changes the path of the traffic to the destination network to the less preferred LSP, so that traffic smoothly switches over to the less preferred LSP from the backup LSP. If the less preferred LSP is just the backup LSP, traffic does not need to switch back to the less preferred LSP from the backup LSP. Even so, traffic still experiences the backup LSP phase and the less preferred LSP phase after route convergence, except that traffic just passes the same link in the two phases.

4.5.2 Configuration

Network Environment

When the LDP cannot effectively protect traffic on an MPLS network, LDP FRR can be configured on ports to protect the traffic and avoid traffic loss.

Prerequisites

Complete the following tasks before configuring LDP FRR:

- ❖ Enable MPLS.
- ❖ Configure MPLS LDP.

Data Preparations

Prepare the following data before configuring LDP FRR:

- ❖ Interface of the backup LSP, which is also the master interface
- ❖ Next-hop IP address of the backup LSP
- ❖ Name of the access control list (ACL)
- ❖ Priority of the backup LSP
- ❖ Length of the LDP FRR protection timer (Optional)
- ❖ BRD single-hop detection parameters (Optional)

4.5.2.1 Enabling LDP FRR

By default, LDP FRR is disabled on a device. To enable the LDP FRR function on a device, enter the privileged user mode and then run the following commands in turn:

Command	Function
Qtech# configure terminal	Enters the global configuration mode

Qtech(config)#mpls ip	Enables MPLS forwarding  Caution This command is not applicable to forwarding on switch chips.
Qtech(config)#interface type ID	Enters the interface configuration mode
Qtech(config-if-type ID)#mpls ip	Enables LDP forwarding on interfaces (Router configuration)
Qtech(config-if-type ID)#ip ref	Enables fast forwarding on interfaces
Qtech(config-if-type ID)#label-switching	Enables MPLS packet processing on interfaces
Qtech(config-if-type ID)#exit	Exits the interface configuration mode
Qtech(config)#mpls router ldp	Enters the LDP configuration mode
Qtech(config-mpls-router)#ldp router-id <i>Loopback ID</i> force	Sets the router ID to a loopback ID (The settings immediately take effect)
Qtech(config-mpls-router)#exit	Exits the LDP configuration mode
Qtech(config)#interface type ID	Enters the interface configuration mode

To disable LDP FRR, run the **no mpls ldp frr [nexthop nexthop-address] [acl acl-name] [priority priority]** command.



Note

Do not enable or disable LDP FRR during LDP GR.



Caution

You must specify labels to work in free retention mode during LDP FRR configuration.

4.5.2.2 Configuring the LDP FRR Protection Timer (Optional)

If the master LSP link is recovered within the LDP FRR protection timer, traffic switches over to the master LSP link only after the LDP FRR protection timer expires. To configure the LDP FRR protection timer, enter the interface configuration mode and run the following commands in turn:

Command	Function
Qtech#configure terminal	Enters the global configuration mode
Qtech(config)#mpls ip	Enables MPLS forwarding This command is not applicable to forwarding on switch chips.
Qtech(config)#interface type ID	Enters the interface configuration mode
Qtech(config-if-type ID)#mpls ip	Enables LDP forwarding on interfaces
Qtech(config-if-type ID)#ip ref	Enables fast forwarding on interfaces
Qtech(config-if-type ID)#label-switching	Enables MPLS packet processing on interfaces
Qtech(config-if-type ID)#exit	Exits the interface configuration mode
Qtech(config)#mpls router ldp	Enters the LDP configuration mode

Qtech(config-mpls-router)# ldp router-id <i>Loopback ID</i> force	Sets the router ID to a loopback ID (The settings immediately take effect)
Qtech(config-mpls-router)# exit	Exits the LDP configuration mode
Qtech(config)# interface type ID	Enters the interface configuration mode

4.5.2.3 Configuring Single-Hop BFD (Optional)

Run the **bfd bind peer-ip** command to configure single-hop BFD. After single-hop BFD is configured, the status of a BFD session will be indicated in interface status information. Then LDP FRR will detect the interface status and perform switchover accordingly. By default, single-hop BFD is disabled on a device. You can also run the **no bfd bind peer-ip** command to disable single-hop BFD if necessary.



Note Single-hop BFD is optional during LDP FRR configuration. For details about single-hop BFD configuration, see related sections in *BFD Configuration*.

4.5.2.4 Configuring DLDP (Optional)

Run the **dldp ip** command to configure the Device Link Detection Protocol (DLDP) function on a device. By default, probes are tried three times every 100 milliseconds. You can run the **no dldp ip** command to restore the default DLDP settings.



Note For details about DLDP and configuration methods, see related sections in *DLDP*.

4.5.2.5 Verification

After configuring LDP FRR, run the following command to show LSP information:

Command	Function
show mpls rib [all vrf <i>vrf-name</i>]	Shows MPLS routing information

4.5.3 Configuration Example

Networking Requirements

It is necessary to configure LDP FRR, so that at least two links to the destination network are available. As shown in Figure 3-2, two links exist between PE 1 and PE 2.

- ❖ The PE1->P1->PE2 link is the master LSP.
- ❖ The PE1->P2->P1->PE2 link is the backup LSP.

LDP FRR can be configured on PE 1 and P1 to protect links between PE 1 and P1 and therefore avoid traffic loss.

Topology

Figure 3-2 Network Topology for Configuring LDP FRR

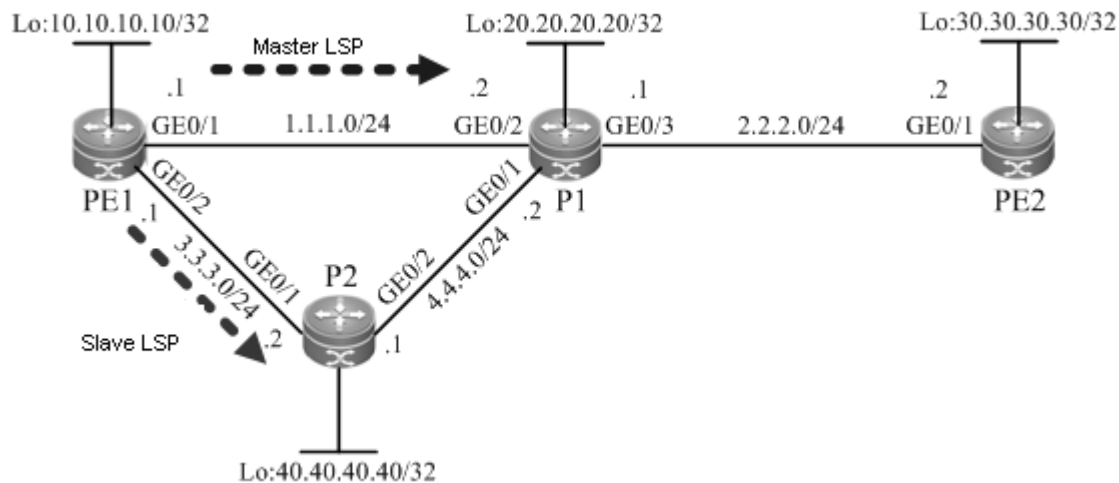

Notes

Configure all device as follows:

- ❖ Configure interface IP addresses and the OSPF protocol on devices.
- ❖ Enable global MPLS forwarding on devices, and MPLS packet forwarding and the LDP on interfaces.
- ❖ Configure the LDP so that the network can forward MPLS traffic.
- ❖ Configure LDP FRR.
- ❖ Enable LDP FRR on the interfaces of PE 1 and P1 so as to generate the backup LSP.
- ❖ Configure the LDP FRR protection timer on the interfaces of PE 1 and P1.
- ❖ Configure single-hop BFD on the interfaces of PE 1 and P1.

Configuration Steps

- ❖ Configure interface IP addresses and the OSPF protocol on devices.

Configure PE 1.

```
Qtech#configure terminal
Enter configuration commands, one per line. End with CNTL/Z.
Qtech(config)#interface gigabitEthernet 0/1
Qtech(config-if GigabitEthernet 0/1)#no switchport
```

```
Qtech(config if GigabitEthernet 0/1)#ip address 1.1.1.1 255.255.255.0
Qtech(config if GigabitEthernet 0/1)#exit
Qtech(config)#interface gigabitEthernet 0/2
Qtech(config if GigabitEthernet 0/2)#no switchport
Qtech(config if GigabitEthernet 0/2)#ip address 3.3.3.1 255.255.255.0
Qtech(config if GigabitEthernet 0/2)#exit
Qtech(config)#interface loopback 0
Qtech(config Loopback 0)#ip address 10.10.10.10 255.255.255.255
Qtech(config Loopback 0)#exit
Qtech(config)#router ospf 1
Router(config router)#network 1.1.1.1 255.255.255.0 area 0
Router(config router)#network 3.3.3.1 255.255.255.0 area 0
Router(config router)#network 10.10.10.10 255.255.255.255 area 0
Router(config router)#exit
```

Configure the other devices by running the same commands as those on PE 1.

- ❖ Enable global MPLS forwarding on devices, and MPLS packet forwarding and the LDP on interfaces.

Configure PE 1.

```
Qtech#configure terminal
Enter configuration commands, one per line. End with CNTL/Z.
Qtech(config)#mpls ip
Qtech(config)#interface gigabitEthernet 0/1
Qtech(config if GigabitEthernet 0/1)#label switching
Qtech(config if GigabitEthernet 0/1)#mpls ip
Router(config if GigabitEthernet 0/1)#exit
Qtech(config)#interface gigabitEthernet 0/2
Qtech(config if GigabitEthernet 0/2)#label switching
Qtech(config if GigabitEthernet 0/2)#mpls ip
Router(config if GigabitEthernet 0/2)#exit
```

Configure the other devices by running the same commands as those on PE 1.

- ❖ Configure the LDP so that the network can forward MPLS traffic.

Configure PE 1.

```
Qtech#configure terminal
Enter configuration commands, one per line. End with CNTL/Z.
Qtech(config)#mpls router ldp
Qtech(config mpls router)#ldp router id interface loopback 0 force
```

Configure the other devices by running the same commands as those on PE 1.

- ❖ Configure LDP FRR.

Configure PE 1.

Enable LDP FRR on the interface of PE 1 so as to generate the backup LSP.

```
Qtech#configure terminal
Enter configuration commands, one per line. End with CNTL/Z.
Qtech(config)#interface gigabitEthernet 0/1
Qtech(config if GigabitEthernet 0/1)#exit
```

Configure the LDP FRR protection timer on the interface of PE 1.

```
Qtech#configure terminal
Enter configuration commands, one per line. End with CNTL/Z.
Qtech(config)#interface gigabitEthernet 0/1
Qtech(config if GigabitEthernet 0/1)#exit
```

Configure single-hop BFD on the interface of PE 1.

```
Qtech#configure terminal
Enter configuration commands, one per line. End with CNTL/Z.
Qtech(config)#interface gigabitEthernet 0/1
Qtech(config if GigabitEthernet 0/1)#no bfd echo
Qtech(config if GigabitEthernet 0/1)#bfd interval 50 min_rx 50 multiplier 3
Qtech(config if GigabitEthernet 0/1)#bfd bind peer ip 20.20.20.20 source ip 1.1.1.1
process pst
Qtech(config if GigabitEthernet 0/1)#exit
```

Configure P1.

Enable LDP FRR on the interface of P1 so as to generate the backup LSP.

```
Qtech#configure terminal
Enter configuration commands, one per line. End with CNTL/Z.
Qtech(config)#interface gigabitEthernet 0/2
Qtech(config if GigabitEthernet 0/2)#exit
```

Configure the LDP FRR protection timer on the interface of P1.

```
Qtech#configure terminal
Enter configuration commands, one per line. End with CNTL/Z.
Qtech(config)#interface gigabitEthernet 0/2
Qtech(config if GigabitEthernet 0/2)#exit
```

Configure single-hop BFD on the interface of P1.

```
Qtech#configure terminal
Enter configuration commands, one per line. End with CNTL/Z.
Qtech(config)#interface gigabitEthernet 0/2
Qtech(config if GigabitEthernet 0/2)#no bfd echo
Qtech(config if GigabitEthernet 0/2)#bfd interval 50 min_rx 50 multiplier 3
```

```
Qtech(config if GigabitEthernet 0/2)#bfd bind peer ip 1.1.1.1 source ip 1.1.1.2 process pst
Qtech(config if GigabitEthernet 0/2)#exit
```

Verification

Show MPLS routing information.

Show MPLS routing information on PE 1.

```
Qtech#show mpls rib
Status codes: m  main entry, b  backup entry, *  active, s  stale.
Default VRF:
LSP Information      Total
STATIC LSP          0
LDP LSP             2
RSVP LSP            0
BGP LSP             0
L3VPN LSP           0
LDP LSP:

FEC                In/Out Label      In/Out IF         Nexthop
m* 2.2.2.0/24      /1024             /Gi0/1            1.1.1.2
b 2.2.2.0/24      /1025             /Gi0/2            3.3.3.2
m* 30.30.30.30/32 /1026             /Gi0/1            1.1.1.2
b 30.30.30.30/32 /1031             /Gi0/2            3.3.3.2
```